

ScopeCorder *DL850*

ScopeCorder Vehicle Edition *DL850V*

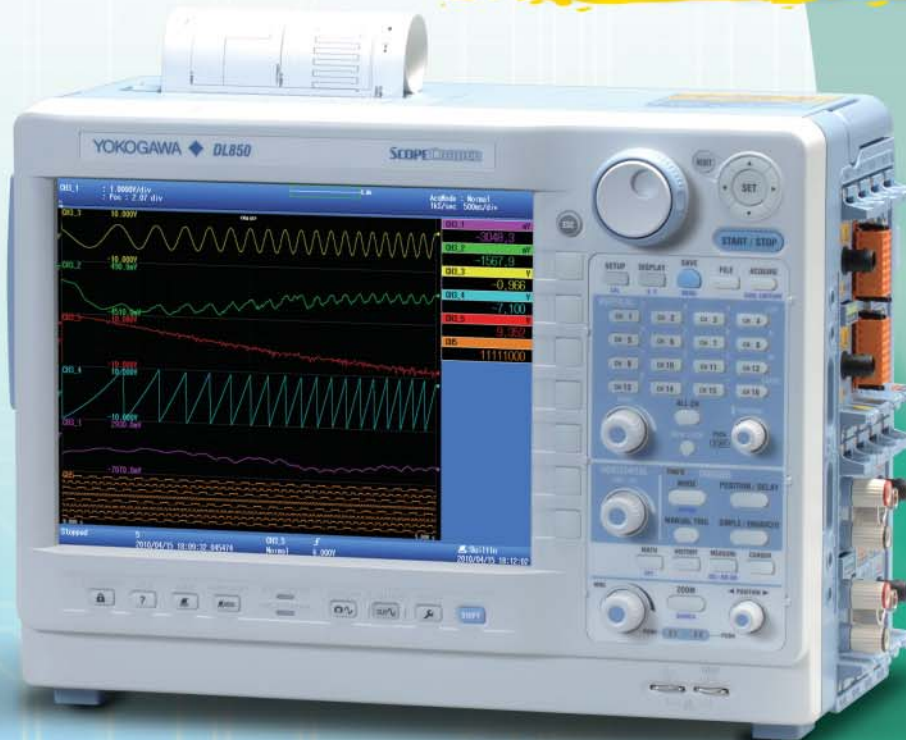

Achieve New Measurement Capabilities with Higher Speeds, Isolation, Channel Count, and CAN.

Introducing Our Ultra-Fast Memory Recorder!

- High-speed (up to 100 MS/s), High Resolution (up to 12-bit), Isolated (up to 1kV^{*1})
- Multi-channel, up to 128 voltage or 128 logic bits
- Continuous hard disk recording at 100 kS/s simultaneously on 16 channels^{*2}
- CAN bus monitoring and trend waveform display (DL850V only)
- 15 plug-in modules

*1. With the isolated probe (700929 or 701947)

*2. With the /HD0 or /HD1 option

For more information, please visit:

tmi.yokogawa.com

Test & Measurement Instruments



3-Year Warranty



Measure Fast Signals with High Accuracy and Time Resolution

The DL850 ScopeCorder Series are modular, waveform recording instruments that can measure voltage, current, strain, acceleration, and other phenomena-- simultaneously. With high speed sampling, high isolation withstand voltage, and multichannel measurements, the DL850 Series offers powerful support in the development, evaluation, and quality control of energy efficient devices.

ScopeCorder DL850/ DL850V

ScopeCorder Vehicle Edition



DL850

DL850V

With 15 unique plug-in module types, the DL850 can handle nearly any measurement task.

The DL850 is backwards-compatible with all modules of its predecessor, the DL750. In addition, four new modules have been added to the lineup. Combine modules at will to measure anything from minute voltages to high-speed, high withstand voltages.

- High-speed voltage **NEW!**
- High voltage
- High-precision voltage
- Multichannel voltage **NEW!**
- Temperature
- Strain
- Acceleration
- Frequency
- Logic input **NEW!**
- CAN monitoring (with the DL850V) **NEW!**



For increasingly fast inverter signals

High speed (100 MS/s), High resolution (12-bit), 1kV isolated measurements.* * With a combination of the high-speed isolation module and the model 700929 or 701947 probe

Yokogawa's isoPRO technology offers industry-leading isolation performance at the highest speeds. The isoPRO core technology is designed with energy savings applications in mind. It gives you the performance needed to develop high efficiency inverters, which employ high voltages, large currents, and high operating speeds.

isoPRO High speed & high withstand voltage isolation technology



Using high speed optical fiber-based transmissions, the module achieves high speed ADC clock and data isolation.

720210
High-speed 100 MS/s 12-Bit Isolation Module
(Max. four (4) modules can be installed in a main unit.)



Example: Measuring inverter output

Accurately observe inverter startup waveforms with sufficient time resolution. You can confirm that no excessive overshoots occurred.

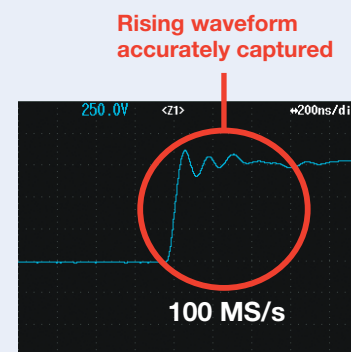
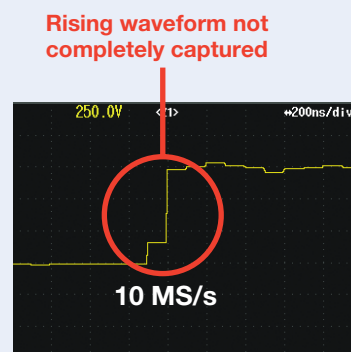
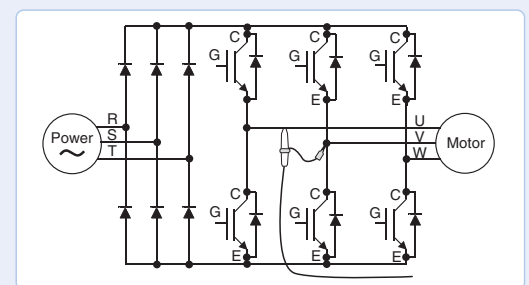

Example: Same inverter output waveform measured at 10 MS/s and 100 MS/s

Advanced-even more measurement points

Up to 128 CH of voltage input, and 128 bits of logic input

The 16-CH Voltage Input Module (scanner type) can measure at 10 kS/s sample rate even when using all 16 channels. With this module populating all 8 input module slots, the DL850 performs 128-CH voltage measurements.

The Logic Input Module supports everything from TTL levels, to high voltage contact closures at up to 10 MS/s*. With eight logic modules, the DL850 can monitor and capture 128 bits of logic.

Example: Measuring a multi-output power source
Power supplies used in home computing electronics have many outputs. With a multichannel module, you are not limited to voltage measurements; a single unit can also measure everything from PC control signals to AC fan operation and slow to high-speed signals.

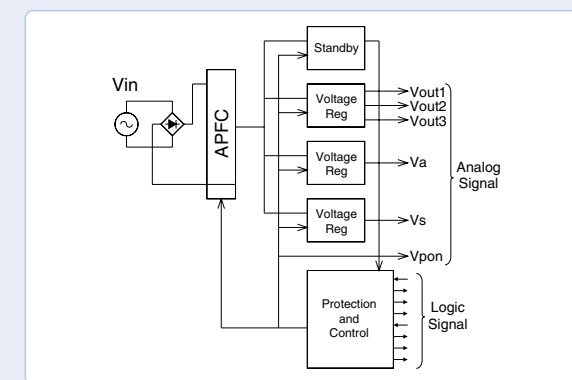

Ch 1: AC Input voltage
Ch 6: Supply voltage
Ch 2: Reference voltage
Ch 3: Reset signal

Ch 1: Fan Rotation
16-bit logic: Control Signals
4-bit logic: Serial communication



* A response time for the logic input varies according as the probe.

Display and Record Vast Amounts of Data with Long Memory and Easy Operation

10.4-inch LCD XGA (1024 x 768)
The large, high resolution LCD screen displays multiple channels in precise detail

Jog shuttle
Lets you easily set parameters with wide dynamic ranges

4 directional cursor keys
With large pop-up menus and 4 directional cursor keys, it is easy to enter and modify settings with many parameters.

One Button SAVE
Select data or image format you wish to save in advance, then simply press one button to save everything at once.

ALL CH key
A spreadsheet style view of all channel settings is displayed for easy editing.

Dedicated vertical axis and zoom knobs
Direct accessibility means faster and easier settings!

Panel sheets in your language
Select an adhesive sheet in any of 8 languages for the instrument's front panel

Snapshot key
Efficiency from Settings to Measurement, Analysis, and Saving

Large (2 GPoint) memory offers long duration measurement and two instantaneous zoom locations —2 GPoint memory (/M2 option)—

Comes standard with 250 MPoints of memory, expandable with 1 or 2 GPoint options. Large capacity memory does not simply provide longer durations of measurement.

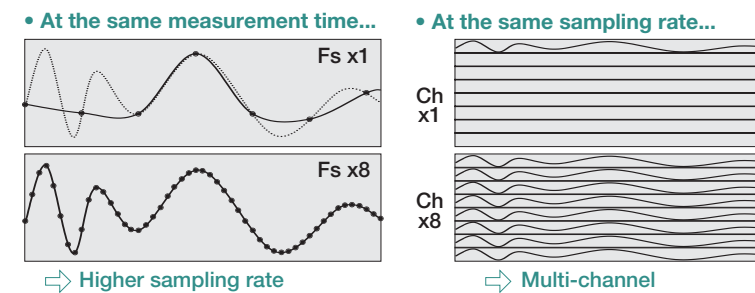

Measurements possible with a 2 GPoint long memory

Sample rate	With 1 ch	With 16 ch
100 MS/s	20 sec.	2 sec. (using 8 ch)
10 MS/s	3 min. 20 sec.	10 sec.
1 MS/s	30 min.	1 min. 40 sec.
100 kS/s	5 hours	10 min.
10 kS/s	50 hours	2 hours 30 min.
200 S/s	30 days	50 hours
20 S/s	30 days*	30 days

* 30 days is maximum.



Zoom to 2 locations instantaneously

Main screen: 20 days of recording (2 days/div)
By a factor of 1,728,000
Zoom screen: 1 hour (12 min/div) & 1 second (100 ms/div)

Instantly zooms 1 second (100 ms/div) even when the main screen is displaying 20 days of recording (2 days/div)

Long memory does not guarantee better efficiency if the memory handling and display engine is slow. Our faster than ever GiGAZoom 2 Engine instantaneously zooms into two locations.

Long Duration, Continuous Saving of Waveforms —Hard disk recording (/HD0, /HD1 option)—

Measured data can be streamed directly to a built-in 160 GB hard disk (/HD1 option)¹ or through the external HDD interface (/HD0 option)¹. With long duration evaluation testing, measurements can be performed at 100 kS/s on 16 channels simultaneously for 10 hours².



Sample rate	With 1 ch	With 16 ch
1 MS/s	10 hours	-
200 kS/s	60 hours	-
100 kS/s	5 days	10 hours
20 kS/s	20 days	2.5 days
1 kS/s	30 days ²	30 days

¹ The /HD0 and /HD1 options cannot be specified together.
² It depends on the external hard disk connected when using the /HD0 option.

100 kS/sec with 16 ch simultaneously

Divides and saves measured data across multiple files!

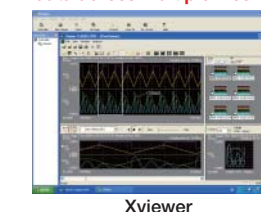

Xviewer

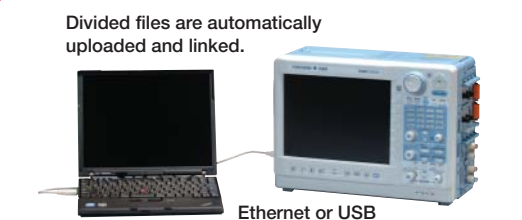

Divided files are automatically uploaded and linked. Ethernet or USB

Performs waveform analysis without stopping measurement

Data being continuously recorded on the DL850/DL850V's built-in HDD or external HDD can be transferred to a PC without stopping measurement. You can display and analyze the transferred waveform data using Xviewer, an accessory program for the PC.

* This function is Xviewer's option

Key Point 1

If an abnormality occurs during a long duration continuous test, you can analyze the saved measured data without having to stop measurement!

Key Point 2

Easily duplicate critical measured data on the main unit and a PC

Efficiency from Settings to Measurement, Analysis, and Saving

1. Enter input conditions in a full-screen menu
2. Easily zoom to a location of interest
3. Analyze using cursors
4. Save data for reports

A ScopeCorder Shows You the Waveforms You Want

Catch transients in durability with high-speed sampling

— Dual capture —

To visualize long term trends in durability testing and other situations, data is typically acquired at low-speed sample rates. On the other hand, suddenly-occurring transitional phenomena should be captured at high-speed sample rates.

The "Dual Capture" feature resolves these conflicting requirements by recording at two different sampling rates.

Measurements with simultaneous high- and low-speed sampling



Event waveform
Displays the timing at which high speed capture waveforms are acquired

Main waveform
Max: 100 kS/s
Trend waveform displayed in a low-speed Roll mode

Capture waveform
Max 100 MS/s
Capture transients with high speed trigger measurement

Zoom waveform

You can record up to 5,000 phenomena of high speed trigger measurements (up to 100 MS/s) at a record length of 5-500 kPoints while taking trend measurements at up to 100 kS/s.

Example: Parts durability testing
Parts used in automobiles and other transportation vehicles must be highly reliable. The "Dual Capture" function is very effective when performing vibration testing of connectors under varying temperatures.

Chattering occurs!

Chattering is accurately captured at high-speed sampling



Check the frequency of occurrence at low-speed sampling

Recall Past Waveforms

— History Function —

When you spot an abnormal phenomenon during repetitive high speed measurements, often the anomaly has disappeared from the screen by the time you press Stop.

Always active, the "History" function automatically divides the long memory into up to 5,000 "history waveforms" that can be redisplayed at any time.

Searching history waveforms

When you want to extract specific abnormal phenomena, you can perform condition-based searches inside the history waveforms. You can create a rectangular zone on screen and extract only waveforms that pass through or do not pass through the zone. You can also extract data based on parameters such as amplitude or RMS.



Use the jog shuttle to display past waveforms

To extract abnormal waveforms...

To check the history...



You can display all past waveforms, and view a list of acquisition times at min 1 μ s resolution

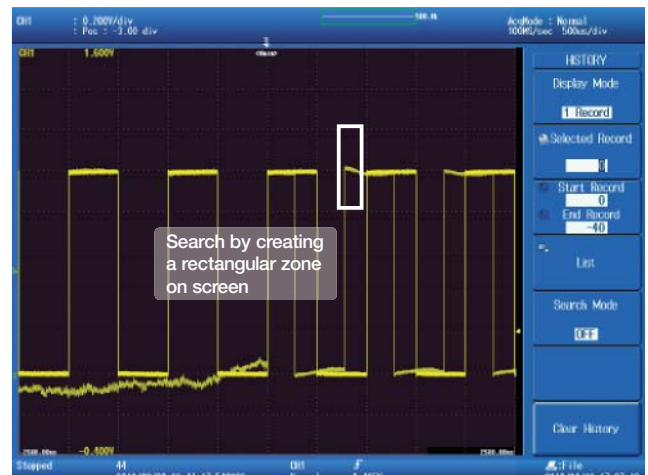

Search by creating a rectangular zone on screen

Key Point

The History function requires no action during measurement. You can recall data at any time after measurement has been completed. Once waveforms have been recalled, you can zoom locations of interest or perform parameter measurements.

Never Miss a Signal

Armed with an array of trigger functions

— Simple & Enhanced Triggers —

The DL offers easy-to-use "Simple" triggers, or lets you combine various "Enhanced" triggers for even more advanced capturing. Enhanced trigger conditions are set up intuitively in advanced, easy-to-understand graphical user interfaces.

SIMPLE

- Edge:** Trigger on a single trigger source condition (rising, falling, rising/falling)
- Time:** Trigger at a specified time or fixed interval

ENHANCED

- A -> B(N):** Trigger when condition B is true N times after condition A becomes true
- A Delay B:** After condition A becomes true, trigger the first time condition B becomes true after a set time has passed
- Edge On A:** Trigger on an OR condition of an edge trigger while the A trigger is true.
- OR:** Trigger if at least one trigger condition of multiple trigger sources is true
- AND:** Trigger if all trigger conditions of multiple trigger sources are true
- Period:** Trigger when a condition regarding the waveform period becomes true
- Pulse Width:** Trigger on a condition relating a pulse width condition being true with a specified time width condition.
- Wave Window:** Trigger when the signal passes outside of an real time template "Wave Window"

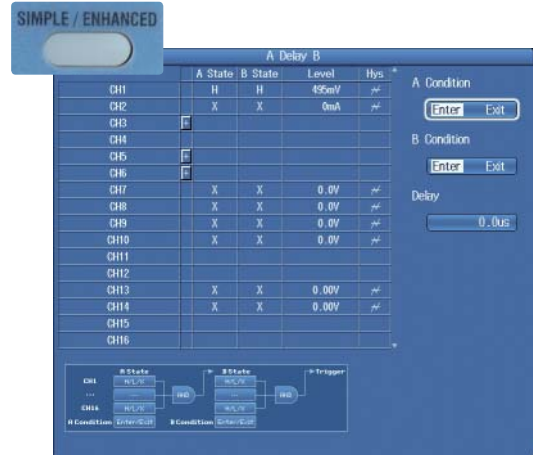

Example: "A Delay B" trigger setup screen (GUI)

— Wave Window trigger —

The Wave Window trigger is useful for diagnosing typical power supply troubles such as momentary loss, sags, and surges. It can also detect frequency changes, voltage drops, and other phenomena, with support for AC waveforms of 40 to 1,000 Hz. A reference waveform (Real time template) is compared with the current waveform, and a trigger activates if the current waveform falls outside of the allowable range. The reference waveform is generated automatically from the previous waveform in real time.

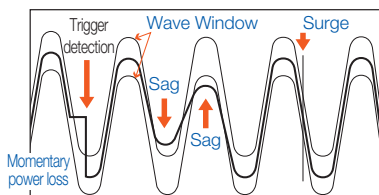

* The Wave Window is not displayed on the display.

— Action ON trigger —

To capture infrequently occurring phenomena, you can use an "Action ON Trigger" to perform multiple actions that are specified in advance when a trigger occurs.

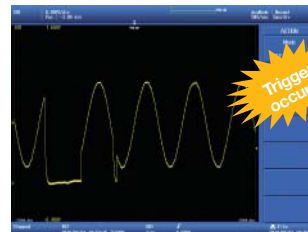

You can specify "e-mail transmission" for immediate notification in a remote location when a phenomenon occurs.

- Beep sounds
- Prints out screenshots
- Saves waveform data
- Saves screenshots
- Sends e-mails to a specified address

! Superior noise rejection

Excellent noise rejection performance is achieved through meticulous low-noise design. Floating voltage switching waveforms in inverter circuits can also be captured with precision.

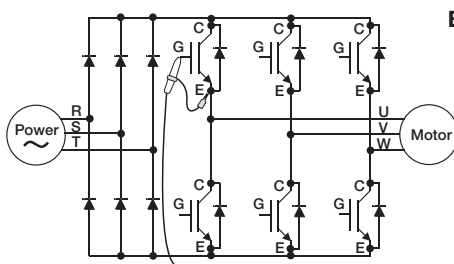

Example: Measuring inverter gate signals



CMRR:
-90dB typ @100 kHz

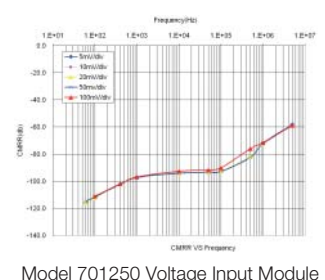

Model 701250 Voltage Input Module

Hardware Accelerated Data Processing and Math

Processes noise rejection and executes power computations in real time — Real time Math (/G3 option) —

The DL850 is armed with a dedicated DSP (digital signal processor) for computations that enables between-channel math during waveform capture. These between-channel computations are powerful because they can be set up separately from filter computations. In addition to FIR, IIR, Gauss, and moving average digital filters, you can use maximum 30 equations such as arithmetic with coefficients, integrals and differentials, and higher-order equations.

- Display any combination of measured and math waveforms (up to 16 total).
- You can even assign channels without modules.

Example: 3-phase power computation

Power is calculated as the integral of the product of voltage and current over time (an average based on the period). Using the Realtime Math function, you can display 3-phase 4-wire power waveforms in real time.

$$\text{Active power } P_n = \frac{1}{T} \int V(t) \cdot I(t) dt \quad \text{3-phase 4-wire } \Sigma P^* = P_1 + P_2 + P_3$$

* Summing the three results after performing calculation of each P_n.

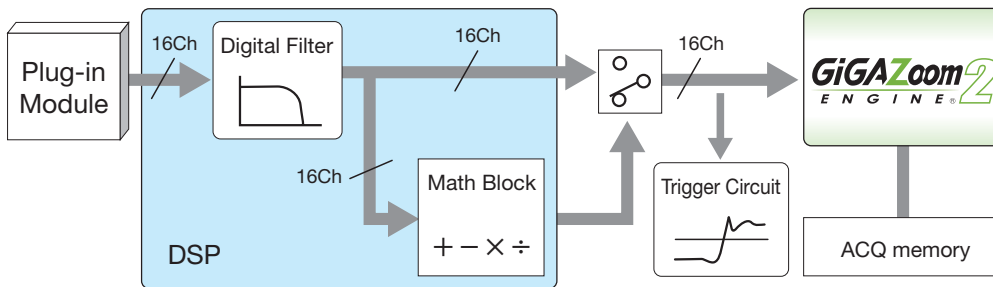

Key Point

Computations occur in real time even when in Roll mode. Computed waveforms can also be used to activate triggers. Any vacant slots (CHs) can be utilized for the realtime math definition. Consequently, pre-computation waveform and post-computation waveform can be displayed simultaneously.

A wealth of functions gets you right to the waveform you want — User defined computation (/G2 option) —

The DL comes standard with arithmetic, time shift, FFT, and other computations that enable you to display waveforms with offsets and skew corrections. And with user defined computations (/G2 option), you can create equations using a combination of differentials and integrals, digital filters, and a wealth of other functions.

Example: Amplitude analysis using FFT

With the User Defined Computation function(option) included, you can perform various-types of FFT analysis using two FFT windows. In applications such as vibration and shock tests, you can easily evaluate abnormal vibrations while simultaneously measuring other signals.

User defined computation setup screen

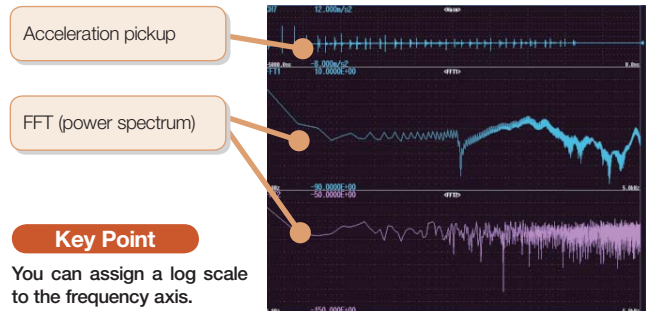

Key Point

You can assign a log scale to the frequency axis.

Automatically extract waveform amplitude, frequency, and other parameters — Waveform parameter and statistical computation —

Extract and display up to 24 of the 26 available waveform parameters (amplitude, frequency, etc.) simultaneously. Menus can be shown as lists of easy-to-read icons.

Statistical computation

The DL can automatically extract cycle waveforms and find the standard deviation and other statistics. Computations can be performed on history waveforms as well.



Detect abnormal waveforms, notify users, and determine pass/fail — GO/NO-GO determination —

The DL can determine whether waveforms or computed values of waveform parameters meet (GO) or do not meet (NO-GO) conditions that are specified in advance. Upon judgment of the measured results, a pre-set action is performed and users are notified that an abnormal waveform was observed, along with the pass/fail determination.

This is a very useful function for such things as studying signals from manufacturing lines of electronic devices and tracing abnormal phenomena.

Example: Evaluating motor startup characteristics

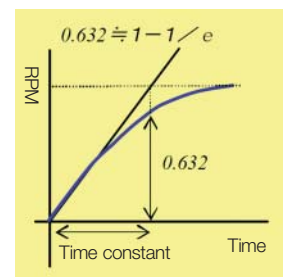

Parameter measurement is taken of the time until reaching a reference RPM after motor start, and the subsequent GO/NO-GO (pass/fail) determination is made.

New Functions, New Possibilities

Synchronize multiple units performing simultaneous measurements

—IRIG input (/C20 option)—

Synchronized measurement across multiple DL850 units is made possible by inputting an IRIG time code signal.* The DL850/DL850V's internal clock is also synchronized (locked) to the IRIG signal. Therefore, timing comparisons are highly precise even when continuously recording over long periods of time.

Example: Synchronous measurements for large transport vehicles
Simultaneously measuring both tips of airplane wings, or between railroad cars requires synchronizing multiple measuring instruments in time. With a single IRIG cable, the acquisition time of all data is made the same.



Key Point

You can make periodic observations remotely by connecting commercially available GPS receivers that have IRIG output and using the Time Trigger function.

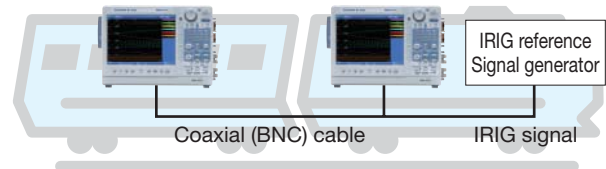

*IRIG (Inter-Range Instrumentation Group) started as an American military standard, and is now used in data recorders in the aerospace industry. The carrier frequency is a 1 kHz/10 kHz ASK (amplitude shift keying) modulating signal with a synchronizing precision of as high as 1 μ s.
DL850 support formats: A002, B002, A132, B122

The flexibility of an external hard drive

— External hard drive interface (/HD0 option)—

With an external hard drive interface, you can connect a commercially available eSATA standard hard drive. The DL can record to an external drive in real time (see p. 5) just like it can with the built-in hard drive. After saving waveforms, you can switch the DL850/DL850V from the PC to the external drive and use the waveform data immediately.

Key Point

(1) Ensures security

Simply remove the drive after measurement to protect data. Or, keep restricted data only at the measurement site.

(2) Increases capacity

If the external hard drive becomes full, you can simply switch to a new one (requires a restart).

(3) Hi-speed data transfer

A data can be transferred at high speed between a PC and a hard drive.

* The external hard drive is an option when specifying the internal hard drive.

* The speed of realtime hard drive saving depends on the performance of the hard drive.



Check the relationship between hysteresis and phase

— XY display function —

You can confirm the relationship between two signals using the X-Y display. This can be applied to measurements such as the phase angle of two sine waves.

You can select four combinations on the X and Y axes, and therefore display multiple X-Y waveforms simultaneously and find relationships between them.

Simultaneous observation of X-Y waveforms and normal T-Y waveforms (waveform display using voltage and time axes) is also possible.

Example: Computing dynamic BH characteristics of a magnetic substance

On the DL850 you can measure voltage and current, then analyze hysteresis of magnetic flux density B and magnetic field strength H. Energy loss generated by magnetostriction can be evaluated by measuring dynamic BH characteristics.

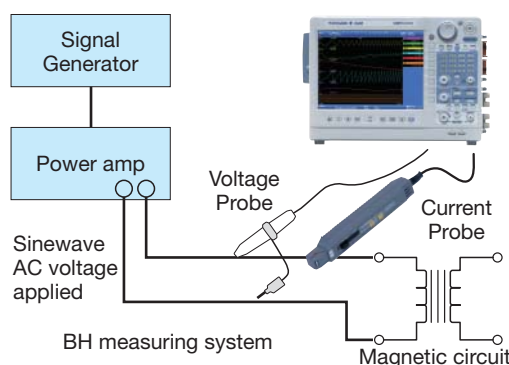

Magnetic flux density: $B = \text{Integ}(C1) / (K1 \cdot K2)$
Magnetic field strength: $H = C2 \cdot K1 / K3$
C1: voltage, C2: current
K1: number of turns, K2: cross sectional area
K3: magnetic circuit length

Special Functions

Snapshots

With the push of "SNAP SHOT" key, you can save a "snapshot" of the measured waveform (the waveform displayed on screen). The waveform remains saved even if you restart measurement, therefore you can easily compare the snapshot with any newly measured waveforms. Snapshots can also be saved and loaded as files.



You can compare waveforms from varied conditions

Example: Comparison of a snapshot waveform (white) with another waveform



Web server

The Web Server function displays the screen of any networked DL850/DL850V on a PC via Ethernet. From this screen, you can remotely start or stop measurement, update the DL's display, and take snapshots (capture images) of the screens.

You can operate controls and acquire screen images with a Web browser—no special software required on the PC.

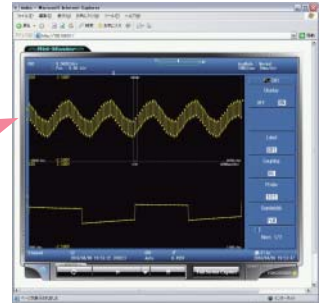

Multilanguage support

Adhesive front panel key label sheets ("panel sheets") are available in eight different languages. Multilanguage support is also provided for menus and error messages.



Saving screen images and displaying thumbnails

Screen images can be saved to a specified storage medium in PNG, JPEG, or BMP format. These screen images can be imported into reports or other PC-created documents.

Screen images saved to storage media are shown on screen as thumbnails for easy identification.



Accessory software (sold separately)

Xviewer (701992)

Xviewer is a high cost-performance, integrated waveform analysis tool offering centralized control of the ScopeCorder, measurement, data transfer, waveform observation, and analysis. The program displays waveforms measured by the DL850/DL850V on a PC and performs analysis. Waveform data (files) can be transferred from the DL850/DL850V to Xviewer via SD memory card or other media, USB, or Ethernet interface. The program supports a variety of functions for the PC

including zoom display, cursor measurements, waveform parameter computation, data conversion to CSV and other formats, creation of reports, and printing. The program not only displays and analyzes waveforms, but also displays an image of the DL850/DL850V front panel on a PC (a "control image") using the GP-IB/Ethernet/USB interface that allows you to control the instrument remotely as if you were operating its actual keys.

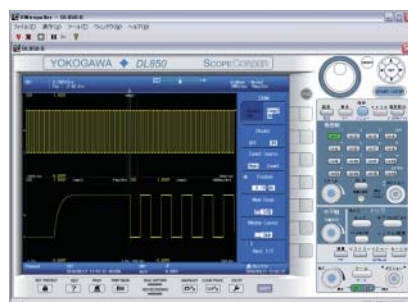
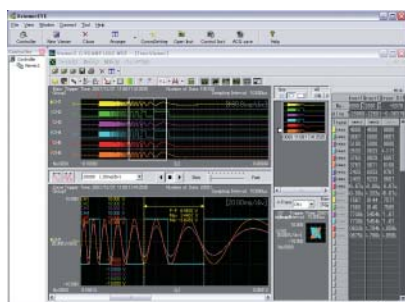

Model Numbers and Suffix Codes

Model	Suffix Code	Description
701992	-SP01	Xviewer Standard Edition (1 license)
	-GP01	Xviewer Math Edition (1 license)
Option	/JS01	DL850 Advanced Utility (1 license)

For details on accessory software, visit <https://y-link.yokogawa.com/YL000.po>
Also, you can download free software and trial versions of retail software from this site.

DL850V Vehicle Edition

ScopeCorder Vehicle Edition

Newly Developed CAN Bus Monitor Module Now Available
A Dedicated ScopeCorder for Vehicle Development and Design

CAN bus is a standard in-vehicle serial bus used for control networks. The DL850V ScopeCorder Vehicle Edition can include a CAN Monitor Module (model 720240) that enables monitoring of CAN protocol communication data as analog values, from which triggers can be activated.

Correlations can be identified between communication data on the CAN bus; voltage, temperature, sensor signals, and other analog data; and ECU control logic signals-this lets you evaluate the overall CAN system.

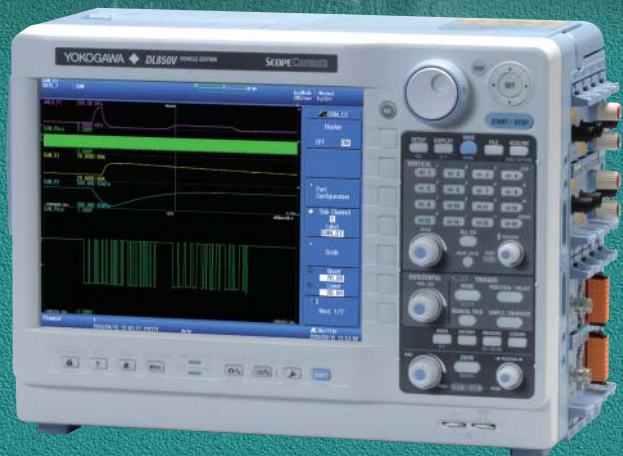

CAN data acquisition and trend display – CAN bus monitor module (model 720240) –

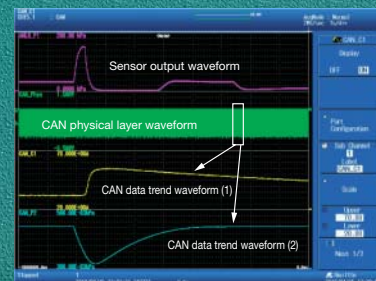
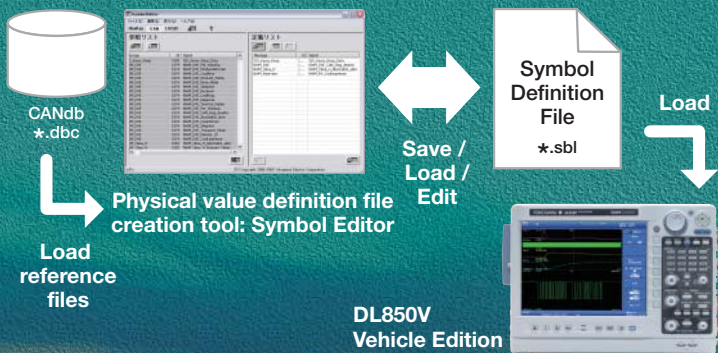

Example: Comparison and verification of actually measured signals and CAN bus signals

You can check physical value trends of CAN bus data and the corresponding actually measured waveforms on the same screen at once. For example, ignition switch ON/OFF signal and the ignition command's corresponding CAN signal can be displayed together with the actually-measured signal from the related voltage sensor or other devices in order to verify any correlation between these signals.

You can also use DBC database files (.dbc) to specify the data to be monitored. Database (definition) files can be loaded and edited by our free Symbol Editor program for conversion to an .sbl file that can be read by the DL850V. Instead of digital code (hex or numeric), you can monitor CAN signals using Messages, Signal names, and physical units.

Model 720240 CAN Bus Monitor module Main specifications

- Input ports: 2 (16 signals x 2 ports)
- Connector type: D-sub 9 pin (male)
- Supported protocols:
 - ◆ Physical layer: ISO-11898 (High Speed Communication)
 - ◆ CAN in Automation: CAN2.0B (Standard & extended message format)
- Bit rates: 10 k, 20 k, 33.3 k, 50 k, 62.5 k, 66.7 k, 83.3 k, 100k, 125 k, 250 k, 500 k, 800 k, 1 Mbps

Note: Max. two(2) modules can be installed in a DL850V main unit.

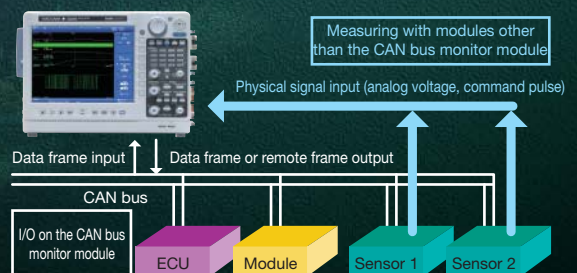

Example of accessory combinations

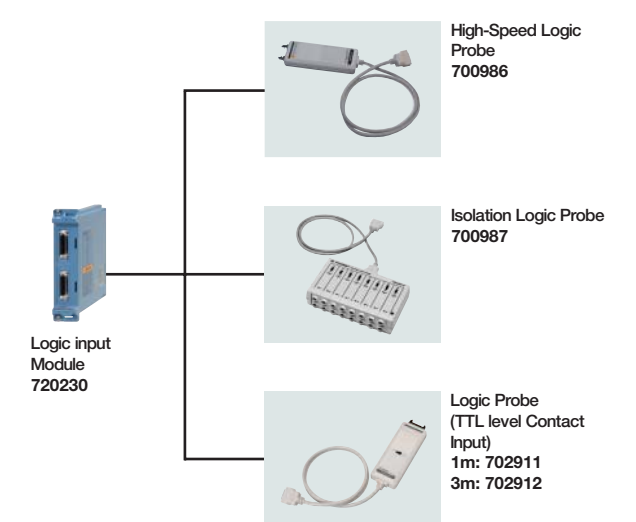
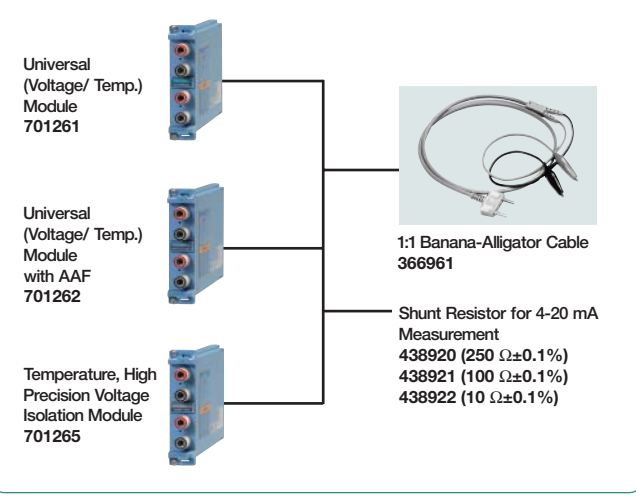
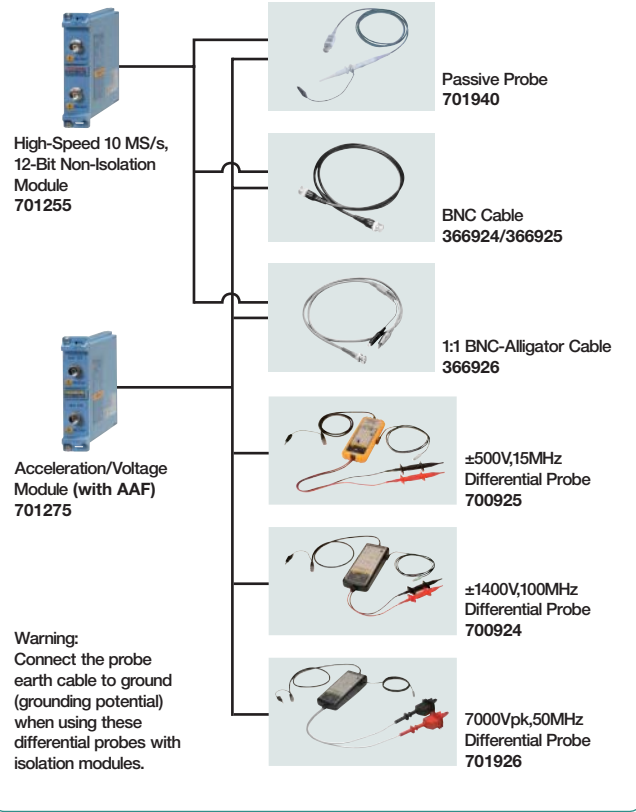
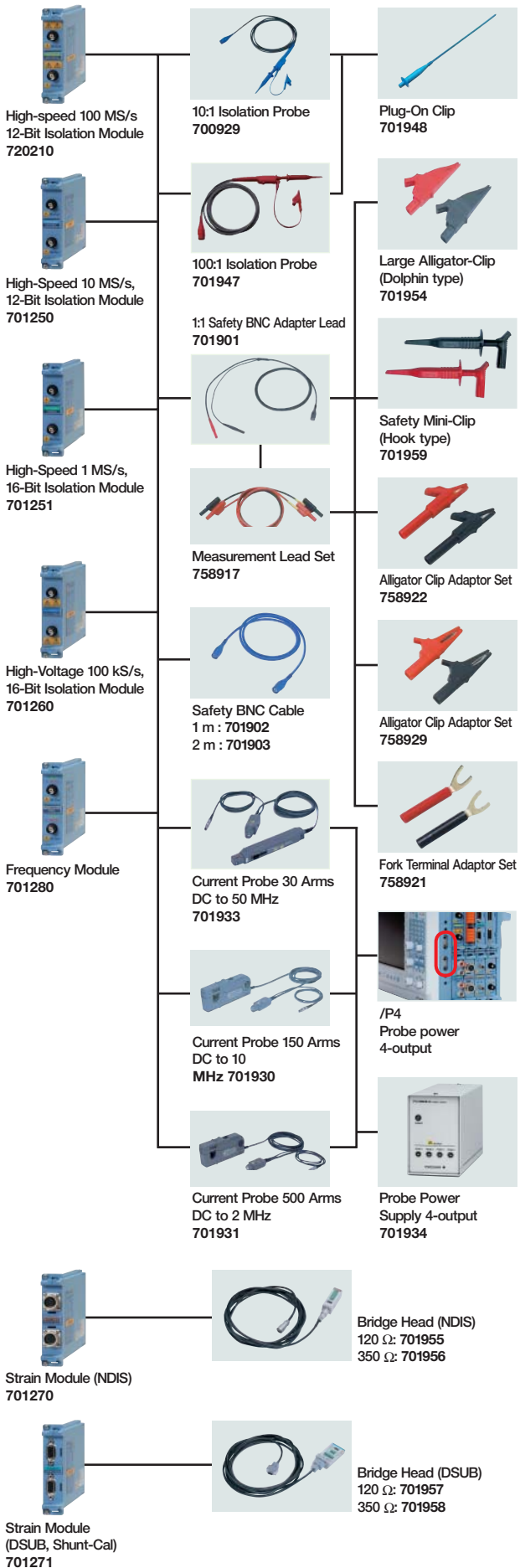

Module Selection

Input	Model No.	Sample Rate	Resolution	Bandwidth	Number of Channels	Isolation	Maximum Input Voltage (DC+ACpeak)	DC Accuracy	Note
Analog Voltage	720210	100 MS/s	12-Bit	20 MHz	2	Isolated	1000 V ² 200 V ³	±0.5%	High speed · High voltage · Isolated Max. four (4) modules can be installed in a main unit. ⁶
	701250 ⁵	10 MS/s	12-Bit	3 MHz	2	Isolated	600 V ² 250 V ³	±0.5%	high noise immunity
	701251	1 MS/s	16-Bit	300 kHz	2	Isolated	600 V ² 140 V ³	±0.25%	High sensitivity range (1mV/div), low noise (±100 μVtyp.), and high noise immunity
	701255 ⁵	10 MS/s	12-Bit	3 MHz	2	Non-Isolated	600 V ⁴ 250 V ³	±0.5%	non-isolation version of model 701250
	701260	100 kS/s	16-Bit	40 kHz	2	Isolated	1000 V ² 850 V ³	±0.25%	with RMS, and high noise immunity
	720220	200kS/s	16-Bit	5 kHz	16	Isolated (GND-terminal) non-isolated (CH-CH)	42V ³	±0.3%	16CH voltage measurement (Scan-type)
Temperature	701261	100 kS/s (Voltage), 500 S/s (Temperature)	16-Bit (Voltage), 0.1°C (Temperature)	40 kHz (Voltage), 100 Hz (Temperature)	2	Isolated	42 V	±0.25% (Voltage)	thermocouple (K, E, J, T, L, U, N, R, S, B, W, iron-doped gold/chromel)
	701262	100 kS/s (Voltage), 500 S/s (Temperature)	16-Bit (Voltage), 0.1°C (Temperature)	40 kHz (Voltage), 100 Hz (Temperature)	2	Isolated	42 V	±0.25% (Voltage)	thermocouple (K, E, J, T, L, U, N, R, S, B, W, iron-doped gold/chromel), with AAF
	701265	500 S/s (Voltage), 500 S/s (Temperature)	16-Bit (Voltage), 0.1°C (Temperature)	100 Hz	2	Isolated	42 V	±0.08 (Voltage)	thermocouple (K, E, J, T, L, U, N, R, S, B, W, iron-doped gold/chromel), high sensitivity range (0.1mV/div), and low noise (±4 μVtyp.)
Strain	701270	100 kS/s	16-Bit	20 kHz	2	Isolated	10 V	±0.5% (Strain)	Supports strain NDIS, 2, 5, 10 V built-in bridge power supply
	701271	100 kS/s	16-Bit	20 kHz	2	Isolated	10 V	±0.5% (Strain)	Supports strain DSUB, 2, 5, 10 V built-in bridge power supply, and shunt CAL
Analog Voltage, Acceleration	701275	100 kS/s	16-Bit	40 kHz	2	Isolated	42 V	±0.25% (Voltage) ±0.5% (Acceleration)	built-in anti-aliasing filter, Supports built-in amp type acceleration sensors (4 mA/22 V)
Frequency	701280	25 kS/s	16-Bit	resolution 50 ns	2	Isolated	420 V ² 42 V ³	±0.1% (Frequency)	Measurement frequency of 0.01 Hz to 200 kHz, Measured parameters (frequency, rpm, period, duty, power supply frequency, distance, speed)
Logic	720230	10 MS/s	—	—	8-bit x 2 ports	non-isolated	depend on logic probe used.	—	(8-bit/port) x 2, compatible with four-type of logic probe (sold separately)
CAN	720240	100 kS/s	—	—	(80signalsx2) port	Isolated	10V	—	CAN Data of max. 32-bit allowable It is available for DL850V only. Max two (2) modules can be installed in a main unit. ⁶

*1: Probes are not included with any modules. *2: In combination with 10:1 probe model 700929 *3: Direct input *4: In combination with 10:1 probe model 701940
*5: Some of the models 701250/701255 shipped on or before July, 2007 may require factory rework. *6: Any other modules can be installed in the remaining slots.

For DL850/DL850V plug-in modules specifications, see the “Bulletin DL850-01EN” catalog.

Variety of Connection Interfaces

■ Video signal output (VIDEO OUT)
Confirm waveforms on an analog RGB (XGA) external display.

■ EXT I/O
GO/NO-GO determinations can be output, and you can perform control based on start/stop and other external signals.

External I/O cable 720911

■ External clock I/O (EXT CLK IN)
Perform sampling timed to an external signal (up to 9.5 MHz).

■ External trigger input (EXT TRIG IN)

■ External trigger output (EXT TRIG OUT)

■ GP-IB (optional)

■ IRIG (optional²)
Inputting an external time signal lets you synchronize multiple DL850s.

■ External hard drive IF (optional¹)
Connect an eSATA standard hard drive.

■ SD card slot
SD, SDHC compliant, comes standard

■ USB-PC connection terminal
Enables control from a PC.

■ USB peripheral connection terminal
Supports USB storage, keyboards, and mouse input.

■ Ethernet 1000BASE-T
Comes standard

*1 Built-in hard disk and external hard disk IF are not available together.
*2 The GP-IB is also available when IRIG (/C20) option is specified.

Main Specifications (Main Unit)

Main Specifications (Main Unit)

Input Section	Plug-in module
Number of slots	8 Max 4 for 720210 modules Max 2 for 720240 modules (for DL850 only)
Number of input channels	DL850: 16CH/Slot, 128CH/Unit DL850V: 120CH/Slot, 336CH/Unit (Maximum simultaneous display waveform is 64 waveforms x 4 screen selectable)
Max recording length	Max recording length depends on kinds of modules and number of channels Standard 250 Mpts (1 CH), 10 Mpts/CH (16 CH ^{*)} /M1 option 1 Gpts (1CH), 50 Mpts/CH (16 CH ^{*)} /M2 option 2 Gpts (1CH), 100 Mpts/CH (16CH ^{*)} 1 pts (point) = 1 W (word)
Time axis setting range	100ns/div to 1s/div (1-2-5 step) 2s/div, 3s/div, 4s/div, 5s/div, 6s/div, 8s/div, 10s/div, 20s/div, 30s/div, 1min/div to 10min/div (1min step), 12min/div, 15min/div, 30min/div, 1h/div to 10h/div (1h step), 12h/div, 1day/div, 2day/div, 3day/div
Time axis accuracy ^{*)}	±0.005%

Trigger Section

Trigger mode	auto, auto level, normal, single, single (N), ON start
Trigger level setting range	0 centered ±10div
Simple trigger	
Trigger source	CHn (n: any input channel), Time, External, Line
Trigger slope	Rising, falling, or rising/falling
Time trigger	Date (year/month/day), time (hour/minute), time interval (10 seconds to 24 hours)
Enhanced trigger	
Trigger source	CHn (n: any input channel)
Trigger type	A→B(N), A Delay B, Edge on A, OR, AND, Period, Pulse Width, Wave Window

Display

Display	10.4-inch TFT color LCD monitor, 1024×768(XGA)
Display resolution of waveform display	selectable either 801×656 (normal waveform display) or 1001×656 (wide waveform display)
Display format	Max 3 simultaneous displays available In addition to main, 2 more waveforms available among zoom 1, zoom 2, XY1, XY2, FFT1, FFT2 (/G2 option)

Function

● Acquisition and display	
Acquisition mode	Normal Normal waveform acquisition Envelope Maximum sample rate regardless of record time, holds peak value Averaging Average count 2 to 65536 (2n steps) Box average Increase A/D resolution up to 4 bits (max 16 bits)
Roll mode	It is effective when the trigger mode is set to auto/auto level/single/ON start, and time axis is greater than 100ms/div.
Dual capture	Performs data acquisition on the same waveform at 2 different sample rates.
Main waveform (low speed)	Maximum sample rate 100kS/s (roll mode region) Maximum record length 100M point
Capture waveform (high speed)	Maximum sample rate 100MS/s Maximum record length 500k point
Realtime hard disk recording (/HD0, HD1 option)	Maximum sample rate Maximum 1MS/s (1CH used), 100kS/s (16CH used) depends on channel used Capacity Depends on HDD vacant capacity Action Data can be stored in the hard disc at the same time of acquisition in accordance with trigger mode.
History memory	Maximum 5000 pages
● Display	
Display format	TY display for 1, 2, 3, 4, 6, 8, 12, 16 division display
Maximum number of display traces	64 trace per 1 display group, selectable in every 4 displays
X-Y display	Selectable X axis/Y axis in CHn, MATHn (max 4 trace x 2 window)
Accumulation	Accumulates waveforms on the display (persistence mode)
Snapshot	Retains the current displayed waveform on the screen. Snapshot waveforms can be saved/loaded.
ALL CH menu	Set all channels while displaying waveforms. Operation using USB keyboard and USB mouse are available.
Expansion/reduction of vertical axis direction	×0.1 to ×100 (varies depending on the module), DIV/SPAN set selectable
Vertical position setting	±5div waveform move is available from the center of waveform screen frame.
Linear scaling	Set AX+B mode or P1-P2 mode independently for CHn

● Analysis, computation

Cursor measurement	Horizontal, Vertical, Marker, Degree (for T-Y waveform display only), H&V
Zoom	Expand the displayed waveform along time axis (up to 2 locations using separate zoom rates) Expanded display 100ns/div to 1/2 of Main waveform Auto scroll Automatically scrolls the zoom position.
Search and zoom	Search for, then expand and display a portion of the displayed waveform. Search conditions Edge count, logic pattern, event, time
History search function	Search for and display waveforms from the history memory that satisfies specified conditions. Zone search/parameter search
Waveform parameters items	Up to 24 items can be displayed P-P Amp, Max, Min, High, Low, Avg, Mid, Rms, Sdev, +OvrShoot, -OvrShoot, Rise, Fall, Freq, Period, +Width, -Width, Duty, Pulse, Burst1, Burst2, AvgFreq, AvgPeriod, Int1TY, Int2TY, Int1XY, Int2XY, Delay(between channels)
Statistical processing	Automated measured values of waveform parameters
Statistics	Max, Min, Avg, Sdv, Cnt
Mode	All waveforms/cycle statistics/history statistics
Maximum number of cycles	64,000 cycles (when the number of parameters is 1)
Maximum number of parameters	64,000
Maximum measurement range	100M points
Computation (MATH)	
Definable MATH waveforms	Max 8
Calculable record length	Max. 1M point (1ch)
Operators	+, -, ×, ÷, binary computation, phase shift, and power spectrum
User-defined computation (/G2 option)	Computation setting is available by combining any following operators and parameter measurement items. ABS, SQRT, LOG, EXP, NEG, SIN, COS, TAN, ATAN, PH, DIF, DDF, INTG, IINTG, BIN, P2, P3, F1, F2, FV, PWHH, PWHL, PWLH, PWLL, PWXX, DUTYH, DUTYL, FILT1, FILT2, HLB, MEAN, LS-, PS-, PSD-, CS-, TF-, CH-, MAG, LOGMAG, PHASE, REAL, IMAG
FFT	
Subject to be computed	CHn, MATHn
Number of channels	1 (/G2 no option), 2 (/G2 option)
Computation points	1k/2k/5k/10k/20k/50k/100k
Time window	Rect/Hanning/Hamming/FlatTop, Exponential (/G2 option)
Average function	Yes (/G2 option)
Real time MATH (/G3 option)	
Number of computation waveforms	Maximum 16 (screen is selectable with any input channel)
Digital filter	Gauss (LPF), SHARP (LPF/HPF/BPF), IIR (LPF/HPF/BPF), MEAN (LPF)
Delay	100ns to 10.00ms (The data will be decimated when the delay time is relatively long.)
Kinds of computation	+, -, ×, ÷, four arithmetic operations with coefficient, Intg, Diff, Rotary Angle, DA conversion, four-order formula with coefficient, RMS, Active Power, Power Integ, Log, Sqrt, Sin, Cos, Atan, Electrical Angle, Poly-Add-Sub, Frequency, Period, Edge Count, Knock Filter(DL850V only)
GO/NO-GO determination	Operate selected actions based on the determination criteria to the captured waveform.
Zone	Determination using combination of up to 6 waveform zones (AND/OR).
parameters	Determination using combinations of 16 waveform parameters
Actions	Screen image data output, waveform data storage, buzzer notification, and e-mail transmission
Action-on trigger	Operates the selected actions each time trigger occurs.
Actions once triggered	Screen image data output, waveform data storage, buzzer notification, mail transmission
● Screen image data output	
Built-in printer (/B5 option)	Prints hard copy of screen.
External printer	Outputs the screen image to an external printer via Ethernet network.
File output data format	PNG, JPEG, BMP
● Other functions	
Mail transmission function	Transmission function by SMTP
PROTECT key	Key protection is available to prevent from careless or unexpected operation.
NUM key	Direct input of numerical numbers is available.
Built-in printer (/B5 option)	
Printing system	Thermal line dot system
Paper width	112mm
Effective printing width	104mm (832 dot)
Feeding direction resolution	8dot/mm
Function	Display hard copy
Storage	
SD card slot	Memory cards conforms to SD, SDHC, maximum capacity 16GB
USB memory	Mass storage device which conforms to USB Mass Storage Class Ver.1.1

Main Specifications (Main Unit)

External HDD/(HD0 option)	Hard disc conforms to eSATA
Built-in HDD/(HD1 option)	2.5 inch, 160GB, FAT32
USB peripheral interface	
Connector type	USB type A connector (receptacle) x 2
Electrical, mechanical specifications	Conforms to USB Rev.2.0*
Supported transmission standards	HS (High Speed) mode, FS (Full Speed) mode, LS (Low Speed) mode
Supported device	Mass storage device which conforms to USB Mass Storage Class Ver.1.1 109 keyboard, 104 keyboard, mouse which conform to USB HID Class Ver.1.1
Power supply	5V, 500mA (in each port) * Connect USB device directly. Composite device is not supported.
USB-PC connection	
Connector type	USB type B connector (receptacle) x1
Electrical, mechanical specifications	Conforms to USB Rev.2.0
Supported transmission standards	HS(High Speed) mode (480Mbps), FS(Full Speed) mode (12Mbps)
Supported protocol	USBTMC-USB488 (USB Test and Measurement Class Ver.1.0)
Supported system environment	Windows7(32bit)/Vista(32bit)/XP(SP2 or later, 32bit) Operates by Japanese/English language and provided with USB port
Ethernet	
Connector type	RJ-45 modular jack x1
Electrical, mechanical specifications	Conforms to IEEE802.3
Transmission system	Ethernet (1000BASE-T/100BASE-TX/10BASE-T)
Communication protocol	TCP/IP
Supported services	Server FTP, Web, VXI-11 Client SMTP, SNMP, LPR, DHCP, DNS, FTP
GP-IB (/C1, /C20 option)	
Electrical specifications	Conforms to IEEE St'd 488-1978(JIS C 1901-1987)
Functional specifications	SH1, AH1, T6, L4, SR1, RL1, PP0, DC1, DT0, C0
Protocol	Conforms to IEEE St'd 488.2-1992
IRIG input (/C20 option)	
Connector type	BNC connector x1
Supported IRIG signals	A002, B002, A132, B122
Input impedance	50Ω/5kΩ selectable

Maximum input voltage	±8V
Function	Main unit time synchronization, sample block synchronization
Clock synchronization range	±80ppm
Accuracy after synchronization	No drift against input signal

Auxiliary I/O section	
EXT CLK IN	BNC connector, TTL level, minimum pulse width 50ns, 9.5MHz or less
EXT TRIG IN	BNC connector, TTL level, rising/falling
EXT TRG OUT	BNC connector, 5VCMOS level, fallen when triggered, and rising when acquisition completed.
EXT I/O	Connector type RJ-11 modular jack
GO/NO-GO determination I/O	Input level TTL or contact input output level 5V CMOS
External start/stop input	input level TTL or contact input
Manual event	input level TTL or contact input
Video signal output	D-Sub 15 pin receptacle Analog RGB, quasi XGA output 1024x768 dot, approx 60Hz Vsync
COMP output (probe compensation signal output terminal)	1kHz±1%, 1Vp-p±10%
Probe power output (/P4 option)	Number of terminals: 4, output voltage ±12V

General specifications	
Rated power supply voltage	100 to 120VAC/220 to 240VAC (automatic switching)
Rated power supply frequency	50/60Hz
Maximum power consumption	200VA
Withstand voltage	1500V AC between power supply and earth for 1 minute
Insulation resistance	10MΩ or higher at 500V DC between power supply and earth
External dimensions	Approx.355mm(W)×259mm(H)×180mm(D), excluding handle and other projections
Weight	Approx.6.5kg (for main unit only, include /B5/M2/HD1/P4 options, exclude chart paper)
Operating temperature range	5 to 40 °C

Standard operation conditions	Ambient temperature 23 ±5 °C
	Ambient humidity 20 to 80 %RH
	Errors in power supply voltage/frequency: Within ±1% of rated voltage, within ±1% of rated frequency warm-up of 30 min. or more, after calibration.

*1 Usage sample of 2CH power voltage input module(701250 and others)
*2 At standard operation conditions
*3 Any source channels of 720220 and 720240 modules can not be switched to Realtime Math channel.

Measurement Range and Display Range

The measurement range of the ScopeCorder is ±10 divisions (20 divisions of absolute width (span)) around 0 V. The display range of the screen is ±5 divisions (10 divisions of span). The following functions can be used to move the displayed waveform and display the waveform outside the display range by expanding/reducing the displayed waveform.

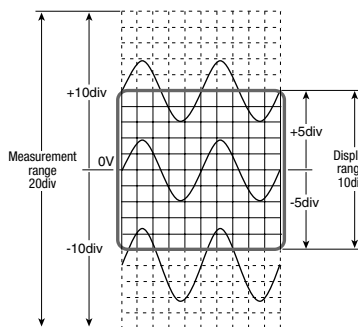

- Move the vertical position.
- Set the offset voltage.
- Zoom in or out of the vertical axis (expand/reduce).

Exterior Dimensions (Unit: mm)

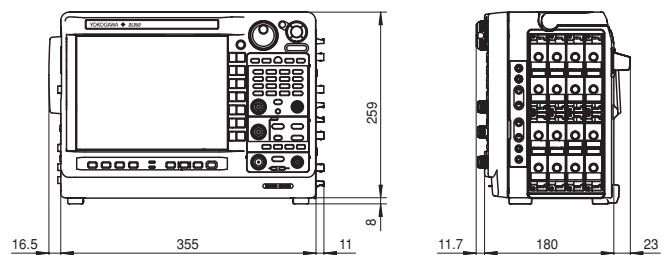

Series related models

— DL750P/SL1400/SL1000 —

DL750P ScopeCorder

- Comes with 210 mm wide chart paper
- Realtime printing function



SL1400 ScopeCorder

- Easy operation
- Multilingual key labels



SL1000 High-Speed Data Acquisition Unit

- High speed transfer of data to a PC
- 100 MS/s simultaneously on 16-Ch
- 8 units linked



Model/Suffix Code		
Model	Suffix Codes	Description
DL850		DL850 main unit, 250MPts(W) memory ^{*1}
DL850V		DL850V main unit, 250MPts(W) memory ^{*1}
Power Code	-D	UL and CSA standard
	-F	VDE standard
	-R	AS standard
	-Q	BS standard
	-H	GB standard
Languages	-HE	English menu and panel
	-HJ	Japanese menu and panel
	-HC	Chinese menu and panel
	-HK	Korean menu and panel
	-HG	German menu and panel
	-HF	French menu and panel
	-HL	Italian menu and panel
	-HS	Spanish menu and panel
Options	/B5	Built-in printer (112mm)
	/M1	Memory expansion to 1Gpts(W) ^{*2}
	/M2	Memory expansion to 2Gpts(W) ^{*2}
	/HD0	External HDD interface ^{*3}
	/HD1	Internal HDD (160GB) ^{*3}
	/C1	GP-IB interface ^{*4}
	/C20	IRIG and GP-IB interface ^{*4}
	/G2	User-defined math function
	/G3	Real time math function
	/P4	Four probe power outputs

*1: Plug-in modules are not included.

*2, *3, *4: Choose either one for each item when specified.

Plug-in Module Model Numbers	
Model	Description
701250	High-speed 10 MS/s 12-Bit Isolation Module (2 ch)
701251	High-speed 1 MS/s 16-Bit Isolation Module (2 ch)
701255	High-speed 10 MS/s 12-Bit non-Isolation Module (2 ch)
701260	High-voltage 100 kS/s 16-Bit Isolation Module (with RMS, 2 ch)
701261	Universal Module (2 ch)
701262	Universal Module (with Anti-Aliasing Filter, 2 ch)
701265	Temperature/high-precision voltage Module (2 ch)
701270	Strain Module (NDIS, 2 ch)
701271	Strain Module (DSUB, Shunt-CAL, 2 ch)
701275	Acceleration/Voltage Module (with Anti-Aliasing Filter, 2 ch)
701280	Frequency Module (2 ch)
720210	High-speed 100 MS/s 12-Bit Isolation Module (2 ch)
720220	Voltage Input Module(16 ch)
720230	Logic Input Module (16 ch)
720240	CAN Bus Monitor Module (32 ch, available DL850V only)

* Probes are not included with any modules.

Note 1: These modules can be used with the DL750/DL750P/SL1000 and SL1400 as well with some exceptions.

Note 2: When using these module(s) with the SL1000, some indications for specifications are different. See the SL1000 instruction manual for details.

Note 3: Max. four(4) 720210 modules can be installed in a main unit.

Note 4: Max. two(2) 720240 modules can be installed in a DL850V main unit.

SCOPECORDER **isoPRO**, **GigaZoom** are trademarks, pending trademarks or registered trademarks of Yokogawa Electric Corporation.

* Any company's names and product names mentioned in this document are trade names, trademarks or registered trademarks of their respective companies.

Probes, Cables, and Converters		
Product	Model No.	Description ^{*1}
100:1 Isolation Probe	701947	1000V (DC+Acpeak) CAT II
10:1 Probe (for Isolated BNC Input)	700929	1000 Vrms-CAT II
1:1 Safety BNC Adapter Lead (in combination with followings)	701901	1000 Vrms-CAT II
Safety Mini-Clip (Hook type)	701959	1000 Vrms-CAT II, 1 set each of red and black
Large Alligator-Clip (Dolphin type)	701954	1000 Vrms-CAT II, 1 set each of red and black
Alligator Clip Adaptor Set (Rated Voltage 1000 V)	758929	1000 Vrms-CAT II, 1 set each of red and black
Alligator Clip Adaptor Set (Rated Voltage 300 V)	758922	300 Vrms-CAT II, 1 set each of red and black
Fork Terminal Adapter Set	758321	1000 Vrms-CAT II, 1 set each of red and black
Passive Probe ^{*2}	701940	Non-isolated 600 Vpk (701255)(10:1)
1:1 BNC-Alligator Cable	366926	Non-isolated 42 V or less, 1m
1:1 Banana-Alligator Cable	366961	Non-isolated 42 V or less, 1.2m
Current Probe ^{*3}	701933	30 Arms, DC to 50 MHz, supports probe power
Current Probe ^{*3}	701930	150 Arms, DC to 10 MHz, supports probe power
Current Probe ^{*3}	701931	500 Arms, DC to 2 MHz, supports probe power
Probe Power Supply ^{*4}	701934	Large current output, external probe power supply (4 outputs)
Shunt Resistor	438920	250 Ω±0.1%
Shunt Resistor	438921	100 Ω±0.1%
Shunt Resistor	438922	10 Ω±0.1%
Differential Probe	700924	1400 Vpk, 1000 Vrms-CAT II
Differential Probe	700925	500 Vpk, 350 Vrms (For 701255)
Differential Probe	701926	7000Vpk, 5000Vrms
Bridge Head (NDIS, 120 Ω/350 Ω)	701955/56	With 5 m cable
Bridge Head (DSUB, Shunt-CAL, 120 Ω/350 Ω)	701957/58	With 5 m cable
Safety BNC-banana Adapter	758924	500 Vrms-CAT II
Printer Roll Paper	B9988AE	For DL750, DL850, DL850V, 10 m x 10
Logic Probe ^{*5}	702911	8-Bit, 1 m, non-Isolated, TTL level/Contact Input
Logic Probe ^{*5}	702912	8-Bit, 3 m, non-Isolated, TTL level/Contact Input
High-speed Logic Probe ^{*5}	700986	8-Bit, non-Isolated, response speed: 1 μs
Isolated Logic Probe ^{*5}	700987	8-Bit, each channel isolated
Measurement Lead Set	758917	Measurement leads (2 per set) Alligator-Clip is required separately.
Safety BNC-BNC Cable (1 m)	701902	1000 Vrms-CAT II (BNC-BNC)
Safety BNC-BNC Cable (2 m)	701903	1000 Vrms-CAT II (BNC-BNC)
External I/O Cable	720911	For external I/O connection
Plug-On Clip	701948	For 700929 and 701947
Long Test Clip	701906	For 700924 and 701926
Terminal	A1800JD	For 720220 input terminal, one (1) piece
Soft Carrying Case	701963	For DL850/DL850V/DL750

*1 Actual allowable voltage is the lower of the voltages specified for the main unit and cable.

*2 42 V is safe when using the 701940 with an isolated type BNC input.

*3 The number of current probes that can be powered from the main unit's power supply is limited.

*4 Any number of externally powered probes can be used.

*5 Includes one each of the B9879PX and B9879KX connection leads.

*6 Additionally, 758917 and either the 758922 or 758929 are required for measurement.

<http://www.scopecorder.net/>

ScopeCorder Special Site

ScopeCorder Series **DL850**



Product photos, videos and demonstrations are available at this dedicated web site. Download the latest DL850 brochure and specifications.

Yokogawa's Approach to Preserving the Global Environment

- Yokogawa's electrical products are developed and produced in facilities that have received ISO14001 approval.
- In order to protect the global environment, Yokogawa's electrical products are designed in accordance with Yokogawa's Environmentally Friendly Product Design Guidelines and Product Design Assessment Criteria.



YOKOGAWA METERS & INSTRUMENTS CORPORATION
 Global Sales Dept. /Phone: +81-42-534-1413 Facsimile: +81-42-534-1426
 E-mail: tm@cs.jp.yokogawa.com

YOKOGAWA CORPORATION OF AMERICA Phone: (1)-770-253-7000, Fax: (1)-770-254-0928
YOKOGAWA EUROPE B.V. Phone: (31)-88-4641000, Fax: (31)-88-4641111
YOKOGAWA ENGINEERING ASIA PTE. LTD. Phone: (65)-62419933, Fax: (65)-62412606

Subject to change without notice.
 [Ed : 03/b] Copyright ©2010
 Printed in Japan, 102(KP)