



Version  
01.01

May  
2007

# R&S® SMJ100A Vector Signal Generator

Versatility in signal generation



**ROHDE & SCHWARZ**

# The multipurpose signal generator



The R&S®SMJ100A meets all challenges that diverse applications place on modern vector signal generators. For example, it offers the signal quality and flexibility required in research and development – not to mention a convenient graphical user interface (GUI). And this is by no means all the R&S®SMJ100A has to offer – a fact that becomes evident in production, where it excels with its flexible baseband and low setting times. The baseband meets all requirements, from providing

realtime signals to replaying precalculated waveforms.

Equipped with a 3 GHz or 6 GHz frequency option, the R&S®SMJ100A covers all important frequency bands essential in digital RF transmission. The internal baseband generator option handles a multitude of digital standards, e.g. GSM/EDGE, 3GPP FDD and CDMA2000®<sup>1)</sup>. Its characteristics make the R&S®SMJ100A the ideal

multipurpose vector signal generator, supporting a wide variety of applications.

To handle future standards, the R&S®SMJ100A features a large bandwidth; thus, new standards such as WiMAX pose no problem. The internal arbitrary waveform generator is proof of its versatility. It offers sequences up to 64 Msamples in length and can be used with diverse signals from R&S®WinIQSIM™ or Matlab.

<sup>1)</sup> CDMA2000 is a registered trademark of the Telecommunications Industry Association (TIA - USA).

## High signal quality

- ◆ I/Q modulator with 200 MHz RF bandwidth
- ◆ Low SSB phase noise of typ.  $-133$  dBc (20 kHz carrier offset,  $f = 1$  GHz, 1 Hz measurement bandwidth)
- ◆ Wideband noise of typ.  $-153$  dBc ( $>5$  MHz carrier offset,  $f = 1$  GHz, 1 Hz measurement bandwidth)
- ◆ Excellent ACLR performance of typ.  $+69$  dB for 3GPP FDD (test model 1, 64 DPCHs)
- ◆ High-stability reference oscillator as standard
- ◆ High level repeatability

## Ideal for production

- ◆ Very short frequency and level setting times ( $<5$  ms); only  $450$   $\mu$ s in List mode for frequency changes
- ◆ Electronic attenuator up to 6 GHz over the entire level range from  $-145$  dBm to  $+13$  dBm

## Internal baseband versatility

- ◆ Four code channels in realtime for 3GPP FDD
- ◆ Different modulation in each slot for GSM/EDGE
- ◆ Baseband generator with realtime signal generation
- ◆ Arbitrary waveform generator with up to 64 Msamples
- ◆ Signals up to 80 MHz bandwidth if the internal baseband generator is used
- ◆ Arbitrary waveform generator supported by Simulation Software R&S®WinIQSIM™
- ◆ Internal 30 Gbyte hard disk provided as standard for storing waveforms and modulation data

## Ease of use

- ◆ Color display with  $800 \times 600$  pixels (SVGA format)
- ◆ Intuitive user interface with graphical display of signal flow (block diagram)
- ◆ Graphical display of baseband signal through built-in transients recorder
- ◆ Context-sensitive Help system
- ◆ Tooltips for all edit fields

## Connectivity

- ◆ Remote control via GPIB and LAN
- ◆ USB connectors for keyboard, mouse and memory stick
- ◆ User-selectable trigger and marker signals



# Easy operation ...

To permit intuitive operation, the R&S® SMJ100A is equipped with a large color display that provides an innovative GUI. The signal flow within the instrument is displayed in a block diagram, with each block representing a functional unit such as RF or baseband. The individual functions and settings are thus clearly assigned. All active components are highlighted in color, providing a quick and effective overview.

The rotary knob plays a key role in R&S® SMJ100A operation. It provides a quick means of navigating in the block diagram or in various menus and selecting parameters by using just one hand. Of course, hardkeys that speed up operation are available for basic functions such as setting frequency and level.

A window structure – like offered by today’s computer operating systems – is the natural evolution of the GUI. This structure allows several different menus to be open at the same time, so that switching between them is possible by using the Winbar. This structure is yet another element that contributes to swift and easy R&S® SMJ100A operation.

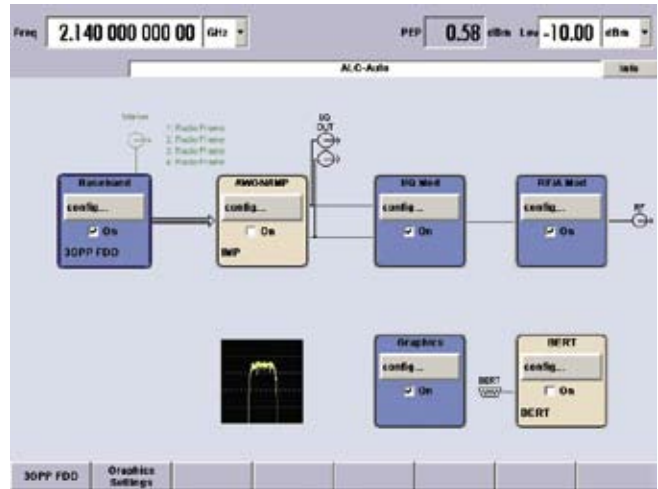

Block diagram of the R&S® SMJ100A



Rotary knob for menu navigation

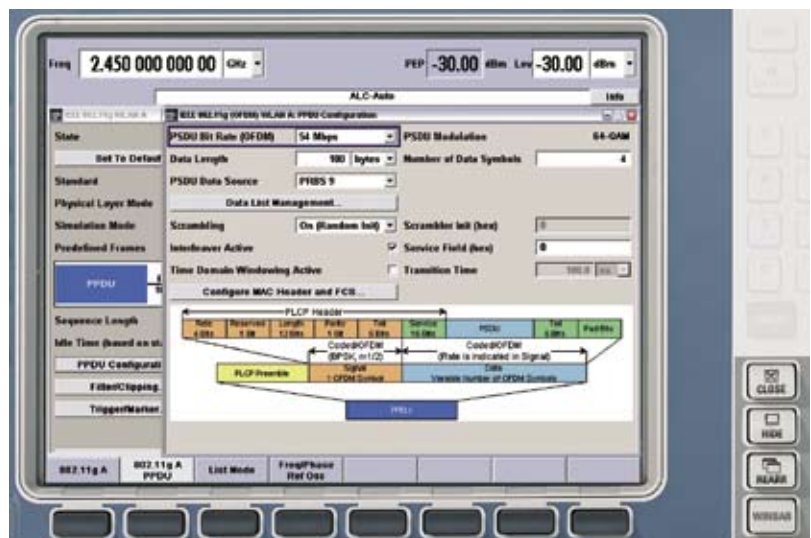

R&S® SMJ100A softkeys and hardkeys for windows management



A context-sensitive Help function supports intuitive menus. The R&S®SMJ100A Help function is particularly useful if you need information about the parameters available within the different standards.

Each edit window offers a tooltip function that specifies the setting range of the selected parameter. If more detailed information is required, the Help function comes in handy. It not only provides background information about various parameters, but also supports the programming of an automatic test setup with remote-control commands. The Help function also provides links to related topics.

Last but not least, the Help function includes the entire operating manual. When software updates are installed, the documentation will automatically be updated as well.

The R&S®SMJ100A comes equipped with an internal graphics block, which is based on an internal transients recorder that analyzes the signals in the base-band chain. The graphics block provides various displays such as spectrum, I/Q and CCDF. This allows the signal to be quickly and easily checked without switching the signal generator directly to the analyzer.

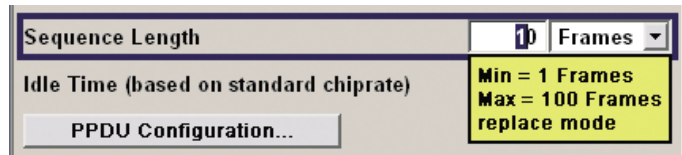

*Tooltip indicating the permissible frequency setting range*

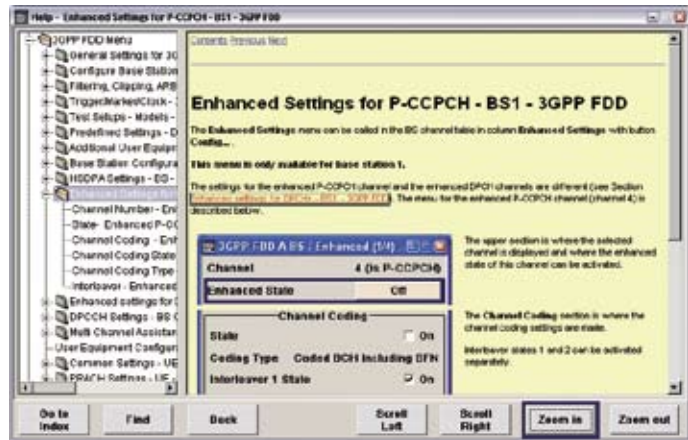

*Context-sensitive Help system*

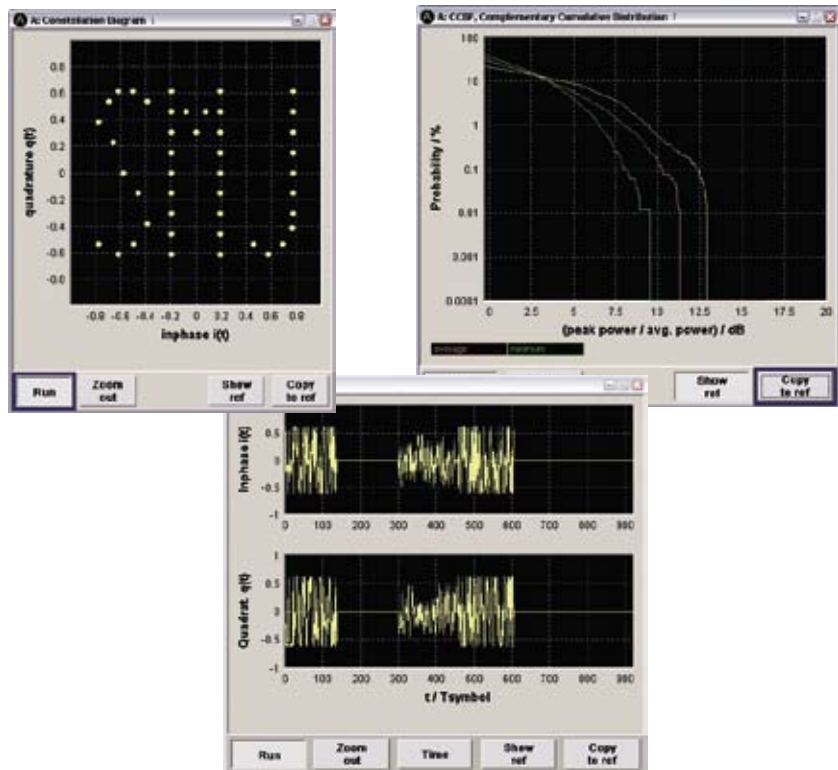

*Graphics block with constellation, CCDF and I/Q diagrams*

# Signal quality

To meet the demands of an all-purpose instrument, the basic RF parameters must be correct. SSB phase noise is one of the key figures. The R&S®SMJ100A's good performance with regard to SSB phase noise is due to its internal architecture, featuring a modern multiloop concept as well as a high-stability reference oscillator as standard.

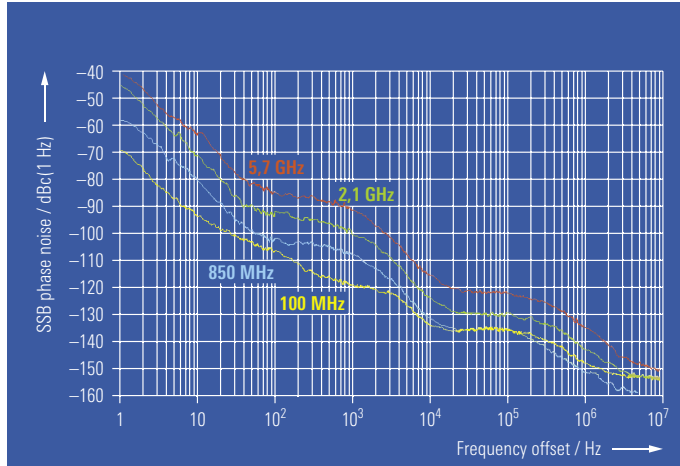

Typical SSB phase noise in the relevant frequency bands

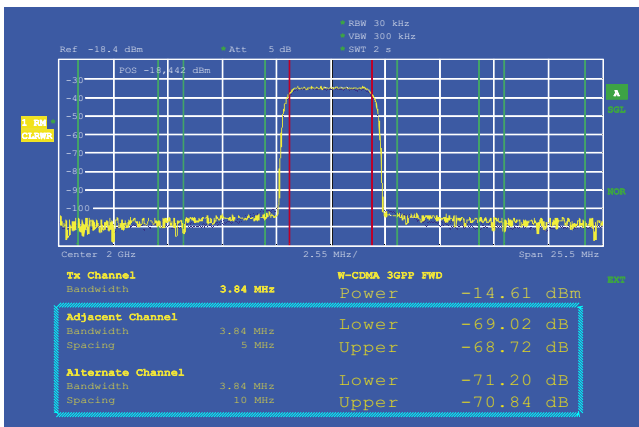

Typical ACLR performance for 3GPP FDD (test model 1, 64 DPCHs)

In addition to its basic RF characteristics, the instrument also offers high application-related performance. The adjacent-channel leakage ratio (ACLR) is an important key figure in 3GPP and especially relevant for testing amplifiers.

Another significant parameter is the error vector magnitude (EVM), which is essential in module and receiver tests, where bit errors are measured on the DUT. The better the signal quality of the generator, the sharper the test criterion – a characteristic that pays off especially in production. What makes the R&S®SMJ100A distinctive is that both excellent ACLR and outstanding EVM are provided without requiring any changes in the settings.

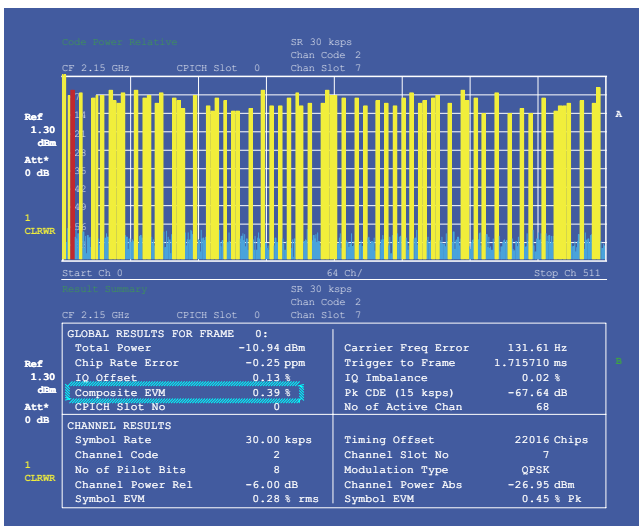

Demodulation of a 3GPP FDD signal

In addition to the main mobile radio standards, the R&S®SMJ100A – because of its large bandwidth and ample frequency coverage – is ideal for important wireless network standards such as WLAN IEEE 802.11 and WiMAX IEEE 802.16. Here, too, the R&S®SMJ100A's EVM capabilities underscore its standing as an all-purpose instrument. In addition, the R&S®SMJ100A offers excellent performance with broadband signals, which is due to the high linearity of the baseband and the I/Q modulator.

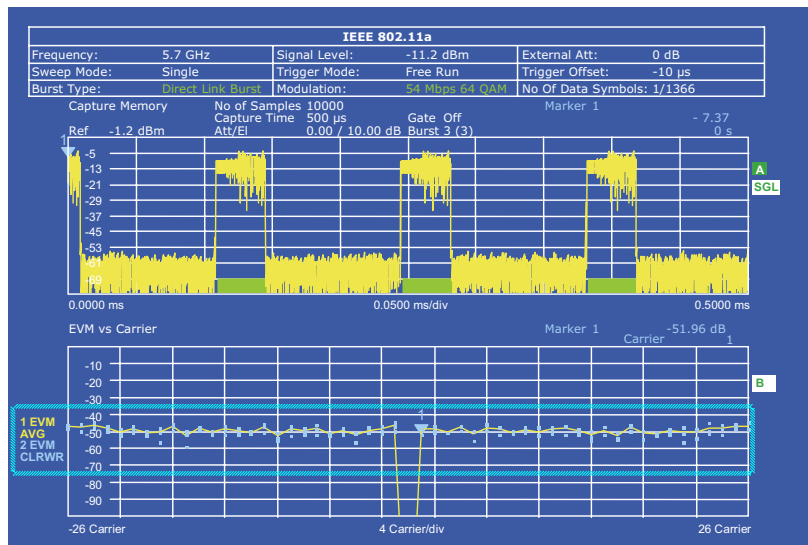

*EVM versus the individual subcarriers with a 54 Mbit/s WLAN signal in accordance with IEEE 802.11a*

IEEE 802.11a							
Frequency:	5.7 GHz	Signal Level:	-11.2 dBm	External Att:	0 dB		
Sweep Mode:	Single	Trigger Mode:	Free Run	Trigger Offset:	-10 µs		
Burst Type:	Direct Link Burst	Modulation:	54 Mbps 64 QAM	No Of Data Symbols:	1/1366		
Result Summary							
No. of Bursts	7						
	Min	Mean	Limit	Max	Limit	Unit	
EVM All Carriers	0.36	0.39	5.62	0.42	5.62	%	
	-48.82	-48.29	-25.00	-47.63	-25.00	dB	
EVM Data Carriers	0.37	0.39	5.62	0.42	5.62	%	
	-48.72	-48.20	-25.00	-47.53	-25.00	dB	
EVM Pilot Carriers	0.29	0.33	39.81	0.38	39.81	%	
	-50.81	-49.55	-8.00	-48.42	-8.00	dB	
IQ Offset	-67.16	-64.72	-15.00	-62.35	-15.00	dB	
Gain Imbalance	-0.09	-0.02		0.02		%	
	-0.01	-0.00		0.00		dB	
Quadrature Error	0.01	0.04		0.08		°	
Center Frequency Error	317.17	353.68	± 105200	394.17	± 105200	Hz	
Symbol Clock Error	1.12	6.27	± 20	11.40	± 20	ppm	
Burst Power	-11.54	-11.54		-11.53		dBm	
Crest Factor	7.73	7.73		7.74		dB	

*Result table for a WLAN IEEE 802.11 signal*



*R&S®SMJ100A with PC and WLAN*

# Full power in the baseband

The flexible baseband generator in the R&S®SMJ100A is the heart of the instrument. It includes a universal coder (for calculating signals in realtime) as well as an integrated arbitrary waveform generator with a memory depth of up to 64 Msamples, sufficient even for long complex test signals. Enhanced with a high system bandwidth of up to 80 MHz, the R&S®SMJ100A can handle various current and future wireless applications.

Its architecture enables the R&S®SMJ100A to support important standards. For example, mobile radio standards such as GSM/EDGE, WCDMA 3GPP or CDMA2000® are already integrated. And other systems such as WLAN IEEE 802.11, WiMAX and GPS are also covered.

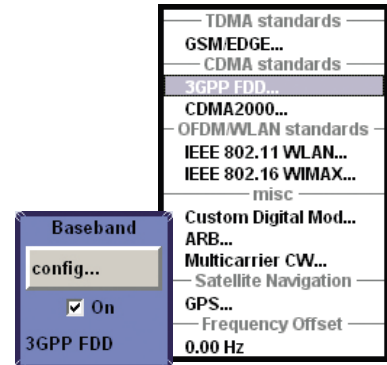

A special feature of the R&S®SMJ100A is its realtime capability. For 3GPP FDD, it provides up to four code channels in realtime. However, to generate a scenario with additional channels, further code channels can be added to the signal. In the uplink, the R&S®SMJ100A supplies signals with different radio measurement channels (RMC). Moreover, the R&S®SMJ100A provides a maximum of 64 additional mobile phones for simulating the actual network load for receiver tests on the base station.

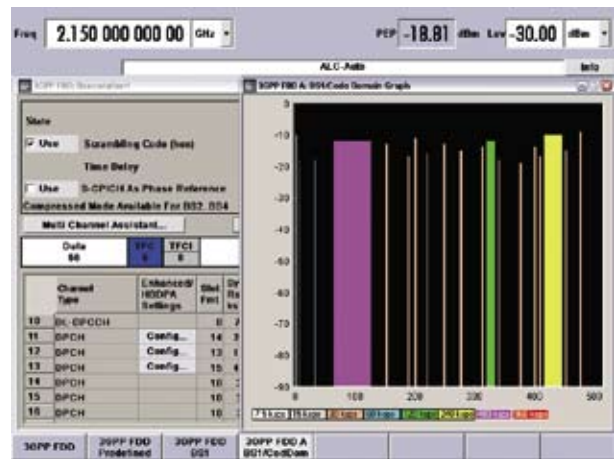

Four code channels in realtime with additional background channels

The R&S®SMJ100A thus generates the reference measurement channels in accordance with the specifications laid down in the 3GPP TS 25.141 and TS 25.101 standards. Complete channel coding in line with the standard is included and can be changed for test purposes.

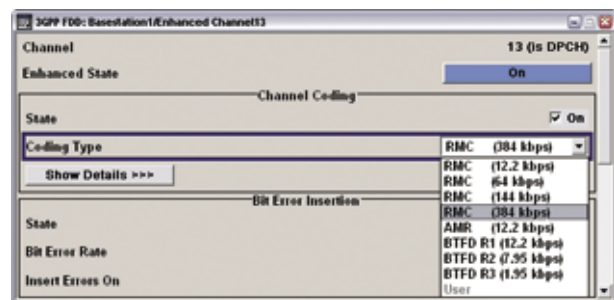

Channel coding selection

To stress the DUT during receiver testing, signals with varying code channel levels are used. Such a scenario may result when a mobile phone is in motion, for example. According to the 3GPP standard, each slot contains a field for controlling the DUT output level. In addition to testing the actual transmit power control (TPC), the level of the relevant code channel can be varied.

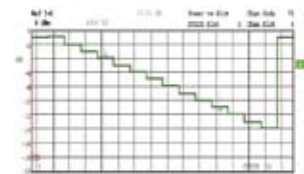

Receiver tests: The R&S®SMJ100A changes the output power of the code channel



The R&S®SMJ100A can selectively generate bit errors and block errors in the coded signal. This allows the internal bit error ratio (BER) and block error ratio (BLER) calculations of a base station to be checked in line with TS 25.141.

In addition to conventional 3GPP signals, the flexible baseband also allows high speed downlink packet data access (HSDPA). Thus, the R&S®SMJ100A already includes test model 5 as defined in TS 25.141 of the 3GPP specification. In addition to the Continuous mode, the R&S®SMJ100A also permits the Packet mode for HSDPA channels in the downlink in line with TS 25.211. The uplink provides the required control channels.

In addition to 3GPP FDD, the R&S®SMJ100A supports CDMA2000® in its 1X mode with full channel coding. It also covers cdmaOne as a subset. Similar to 3GPP FDD, where HSDPA is a special mode for high data rates, CDMA2000® includes 1xEV-DV, also known as radio configuration 10 (RC 10), which the R&S®SMJ100A supports.

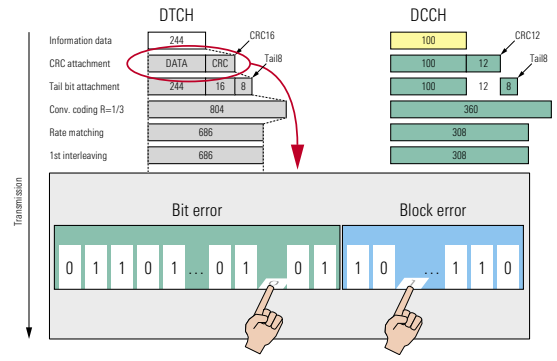

Insertion of bit errors and block errors into the output signal

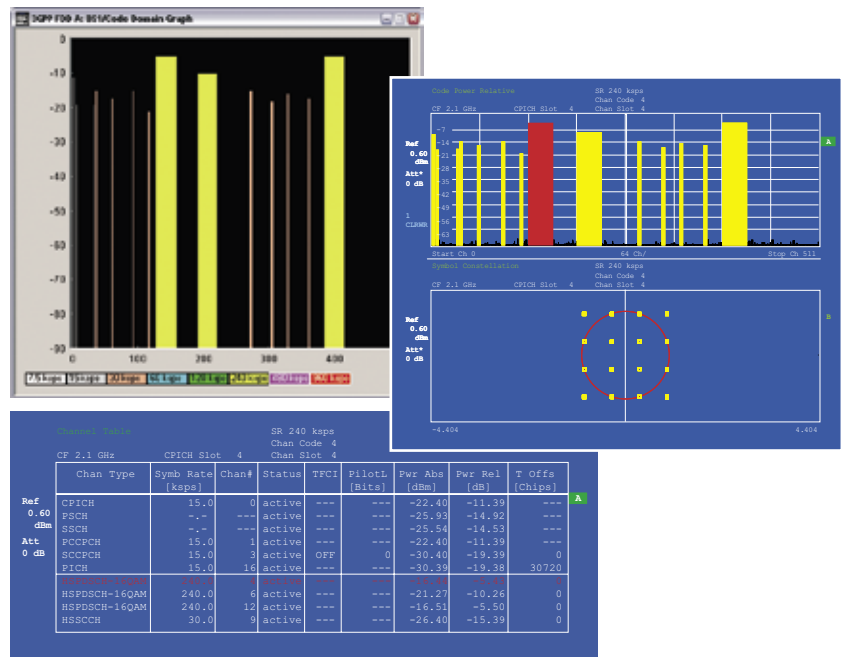

Code domain display in the R&S®SMJ100A with three HSDPA data channels and corresponding results from the signal analyzer (code domain, channel list and constellation diagram of an HSDPA data channel)

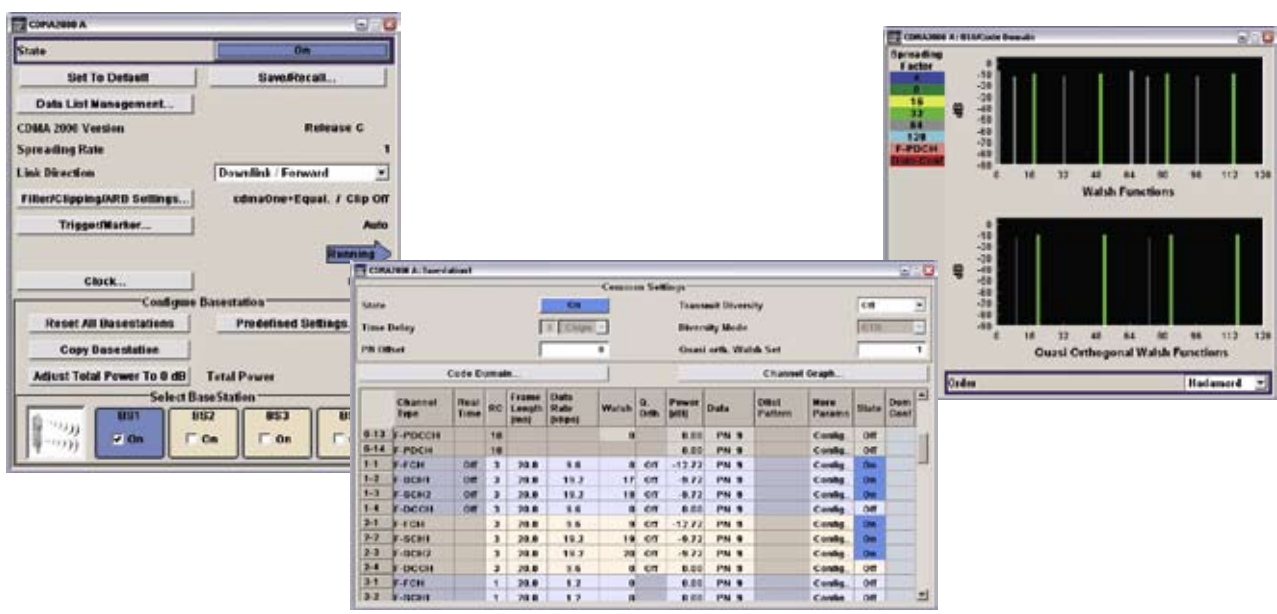

CDMA2000® in the R&S®SMJ100A

Although third-generation mobile radio technology is already being implemented, the second generation with GSM/EDGE is still highly important for many users. The internal GSM/EDGE option offers all burst types of the standard, including half-rate slots where both users are set individually. Moreover, multislot configurations are supported so that multiple slots can be assigned to one user with one common data source.

The R&S®SMJ100A supports a maximum of eight different slot levels, allowing a specific level to be assigned to each slot in a frame. Another important feature is the capability to change between GMSK and 8PSK EDGE modulation from one slot to the next, such as when a change from normal burst to EDGE burst occurs in a base station. To permit maximum flexibility, the R&S®SMJ100A allows two different frames to be defined; the repetition rate is user-definable for each frame. This makes it possible, for example, to simulate a change from GMSK to 8PSK EDGE modulation in one timeslot from one frame to the next.

The internal digital GPS standard generates static signals for the Global Positioning System with up to four satellites. As a result, the R&S®SMJ100A can perform not only basic RF tests but also a function test of a GPS receiver. Since actual Almanach data can be used, signals are realistic. The GPS time can also be set.

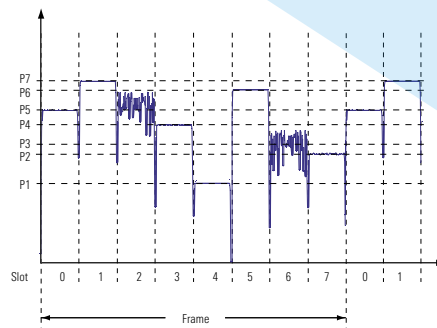
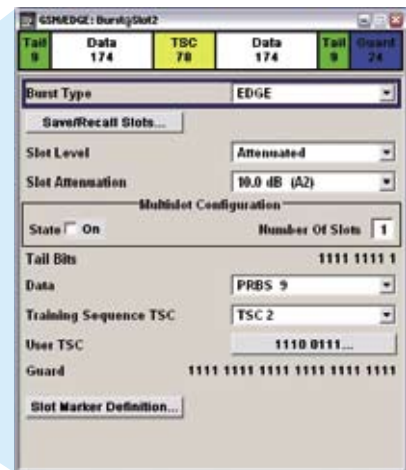
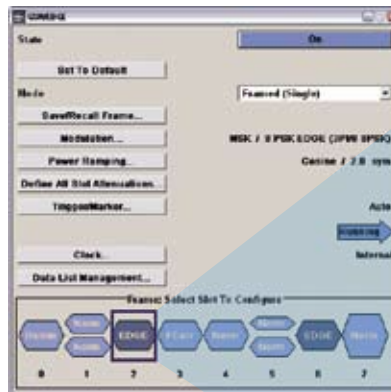

*Change between GSM and EDGE modulation from one slot to the next in the R&S® SMJ100A*

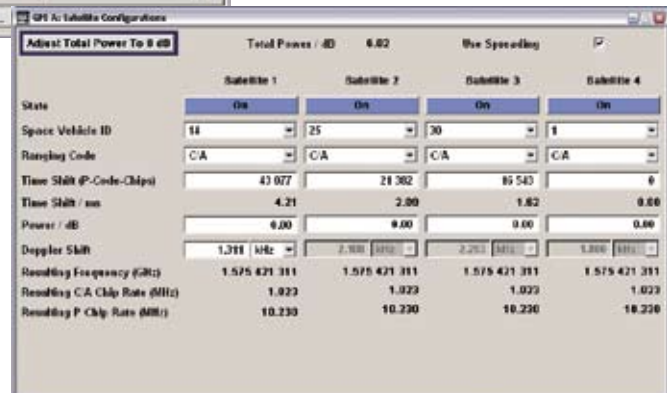

*GPS with up to four satellites*

In addition to the extensive functions in the mobile radio standards, the R&S®SMJ100A also covers the wireless LAN standards IEEE 802.11a, IEEE 802.11b and IEEE 802.11g with complete channel coding. In the OFDM modes, all data rates of the IEEE 802.11a and IEEE 802.11g standards from 6 Mbps to 54 Mbps are supported. The same is true for the CCK mode with data rates from 1 Mbps to 11 Mbps, as well as for the PBCC mode where an optional expansion with data rates up to 22 Mbps has been added to the IEEE 802.11 g standard.

The address of the specified receiver can be defined in the MAC header. Since data is transmitted in packets of different lengths and without a defined time grid, both idle time and packet interval can be set. To perform initial receiver tests, the signal can also be provided as a continuous data stream without packet structure.

The IEEE 802.16 standard – also referred to as WiMAX – is of broad interest as a wireless connection for the last mile. The R&S®SMJ100A supports release 2004, revision d, of this system, including channel coding. Both versions, OFDM and OFDMA, are included. The R&S®SMJ100A offers various uplink and downlink duplex capabilities, including both FDD and TDD.

The user interface provides separate operating menus for the OFDM and OFDMA modes. OFDM on the one hand has a defined FFT length of 256, and only one set of subchannels is used simultaneously; what's of interest here are the different data bursts with the individual subcarrier modulations. On the other hand, OFDMA has a considerably larger FFT size of 2048, so that different subchannel groups can be assigned to different users, which is reflected in the subchannel map of the OFDMA configuration.

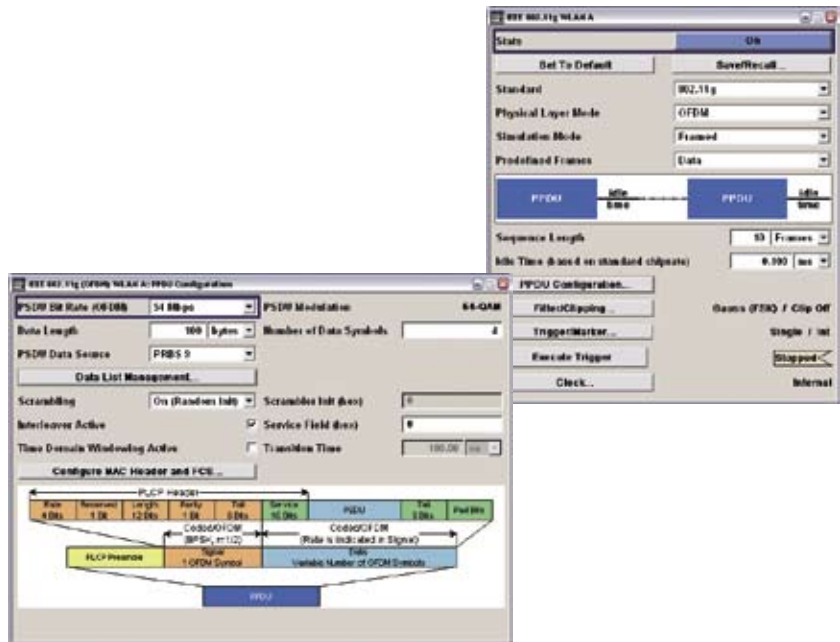

Operating menu for wireless LAN standard IEEE 802.11 (a, b, g)

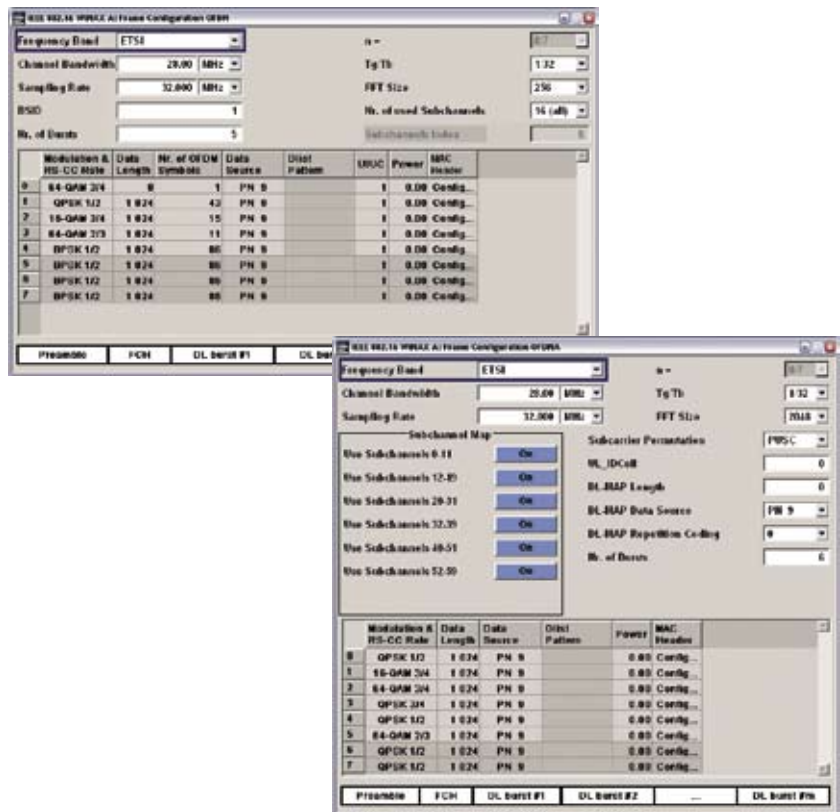

OFDM and OFDMA configuration in the WiMAX system

# Added value

Receiver tests require not only an ideal signal, but often a realistic signal with additive noise. To achieve this, the R&S®SMJ100A allows additive white Gaussian noise (AWGN) to be superimposed on the ideal signal. The signal-to-noise ratio can be set within a wide range.

The 3GPP standard, for example, stipulates tests with noisy signals. Exact level control supports these sensitivity measurements since this is exactly where high-precision level settings and level changes are called for.

The Noise Only and CW Interferer modes are attractive add-on functions. With Noise Only, the R&S®SMJ100A can act as a defined noise source. The other function allows a required CW interferer to be internally added to the wanted signal – a feature that is especially useful for receiver tests (blocking tests).

As an all-purpose instrument, the R&S®SMJ100A not only provides an RF output but also I/Q outputs. These come in useful if the receiver has to be tested at an early stage in development without an RF frontend being available, or if only the baseband module performance is of interest.

The instrument features more than just single-ended outputs; it also provides differential I/Q outputs with variable levels and offsets. Such versatility allows the R&S®SMJ100A to be adapted to the DUT – without requiring an additional matching circuit.

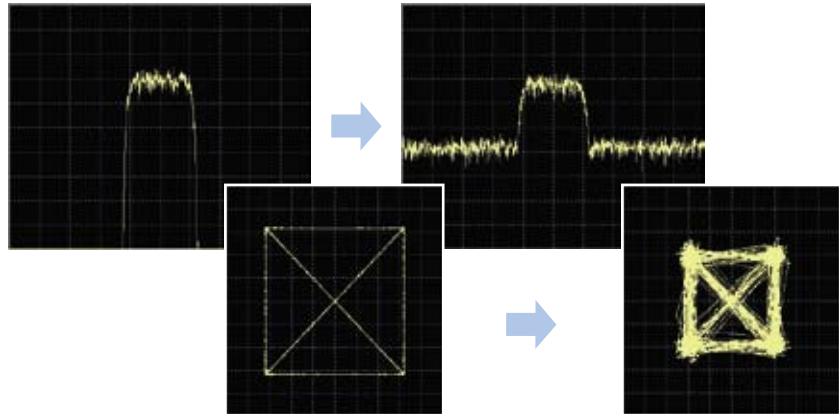

*Influence of additive white noise on spectrum and vector diagram*

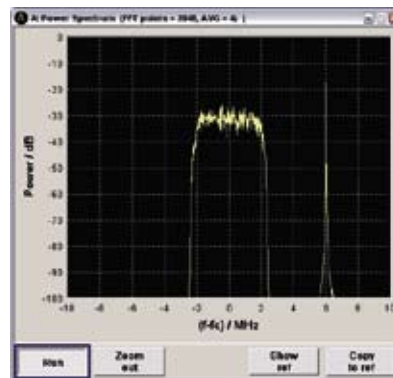

*CW interferer added by using the AWGN option*

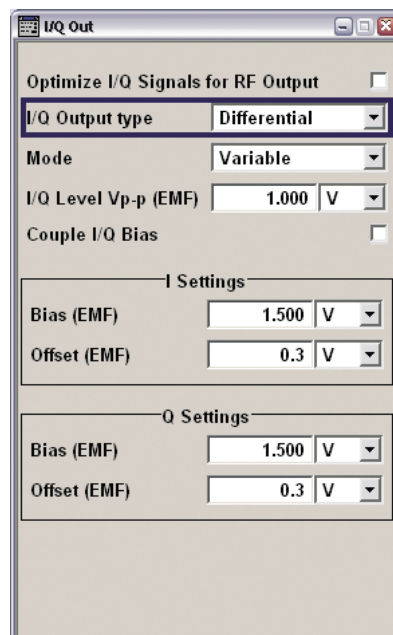

*User interface for I/Q outputs*



# Connectivity

## Front panel

An external mouse and keyboard can be plugged into the front panel via USB connectors. Connecting memory sticks comes in very handy. This allows waveforms for the internal arbitrary waveform generator to be easily transmitted. Thus, the R&S®SMJ100A need not be connected via remote control to generate R&S®WinIQSIM™ signals, for example. This feature definitely simplifies routine lab work.

In addition to a trigger input, there are two marker outputs at the front panel, making lab setup simple. The trigger input allows the R&S®SMJ100A to be involved in DUT timing. The marker outputs offer different signals, depending on the standard. In GSM/EDGE, for example, slot or frame markers are available, in 3GPP FDD a radio frame marker.



## Rear panel

Besides remote-control interfaces, other useful connectors are available at the rear. Additional marker outputs plus another trigger input are provided. An external monitor can be connected via the VGA output.

## Flexible design

The option concept ensures that the R&S®SMJ100A can be optimally configured to meet diverse applications. Future expansions with additional options – as required by new applications – pose no problem.

An all-purpose instrument also needs to offer low cost of ownership. This is why the R&S®SMJ100A comes with a three-year calibration cycle, which increases its availability and reduces calibration costs.

## Remote control

The R&S®SMJ100A can be remote-controlled both via the conventional IEC/IEEE bus and via the LAN interface; due to its higher transmission rate, the LAN interface yields advantages in speed. Moreover, the LAN allows remote operation via Windows Remote Desktop.

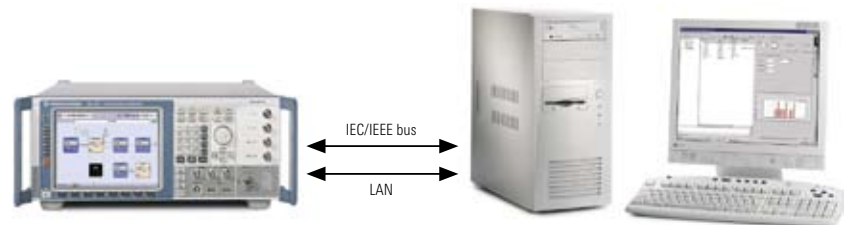

**R&S®SMJ100A remote control via IEC/IEEE bus or LAN**



# Condensed data

<b>Frequency</b>	
Frequency range	100 kHz to 3 GHz/6 GHz
Setting time	<5 ms
Setting time in List mode	<450 $\mu$ s
<b>Level</b>	
Range	-144 dBm to +13 dBm (PEP) [+16 dBm in overrange]
Setting time	<5 ms
<b>Spectral purity (at f = 1 GHz)</b>	
<b>Nonharmonics</b>	
Carrier offset >10 kHz	<-80 dBc
Carrier offset >850 kHz	<-86 dBc
SSB phase noise (20 kHz carrier offset, 1 Hz measurement bandwidth)	typ. -133 dBc
Wideband noise (carrier offset >5 MHz, 1 Hz measurement bandwidth)	typ. -153 dBc (CW) typ. -146 dBc (I/Q modulation)
<b>ACLR performance</b>	
3GPP test model 1, 64 DPCHs	typ. 69 dB
<b>I/Q bandwidth (RF)</b>	
Internal	80 MHz
External	200 MHz
<b>Supported modulation types</b>	
ASK	0% to 100%
FSK	MSK, 2FSK, 4FSK
PSK	BPSK, QPSK, OQPSK, $\pi/2$ DBPSK, $\pi/4$ DQPSK, $\pi/8$ D8PSK, $\pi/4$ QPSK, 8PSK, 8PSK EDGE
QAM	16QAM, 32QAM, 64QAM, 256QAM, 1024QAM
Supported standards and digital systems	GSM/EDGE, 3GPP FDD, 3GPP TDD, TD-SCDMA, cdmaOne, CDMA2000 <sup>®</sup> , 1 $\times$ EV-DO, IEEE 802.11a/b/g, WiMAX, Bluetooth <sup>®</sup> <sup>1)</sup> , AWGN, multi-carrier CW, PM, AM, FM, $\phi$ M, user-defined
Interfaces	IEEE 488.2, LAN (100BaseT), 3 $\times$ USB, 1 $\times$ USB slave, VGA

<sup>1)</sup> The Bluetooth<sup>®</sup> word mark and logos are owned by the Bluetooth SIG, Inc. and any use of such marks by Rohde & Schwarz is under license.

# Ordering information

Designation	Type	Order No.
<b>Vector Signal Generator<sup>1)</sup></b>		
Including power cable, Quick Start Guide and CD-ROM (with operating and service manual)	R&S®SMJ100A	1403.4507.02
<b>Options</b>		
RF Path		
100 kHz to 3 GHz	R&S®SMJ-B103	1403.8502.02
100 kHz to 6 GHz	R&S®SMJ-B106	1403.8702.02
FM/ϕM Modulator	R&S®SMJ-B20	1403.9209.02
Baseband		
Baseband Generator with ARB (64 Msample) and Digital Modulation (realtime)	R&S®SMJ-B10	1403.8902.02
Baseband Generator with ARB (16 Msample) and Digital Modulation (realtime)	R&S®SMJ-B11	1403.9009.02
Baseband Main Module	R&S®SMJ-B13	1403.9109.02
Differential I/Q Output	R&S®SMJ-B16	1403.9409.02
Digital modulation systems		
Digital Standard GSM/EDGE	R&S®SMJ-K40	1404.0305.02
Digital Standard 3GPP FDD	R&S®SMJ-K42	1404.0405.02
3GPP Enhanced MS/BS Tests incl. HSDPA	R&S®SMJ-K43	1404.0505.02
Digital Standard GPS (4 satellites)	R&S®SMJ-K44	1404.1401.02
Digital Standard CDMA2000 <sup>®</sup> 1) incl. 1 × EV-DV	R&S®SMJ-K46	1404.0605.02
Digital Standard IEEE 802.11 (a/b/g)	R&S®SMJ-K48	1404.1001.02
Digital Standard WiMAX	R&S®SMJ-K49	1404.1101.02
Multicarrier CW Signal Generation	R&S®SMJ-K61	1404.0705.02
Digital modulation systems using R&S®WinIQSIM™ 2)		
Digital Standard IS-95 (with R&S®WinIQSIM™)	R&S®SMJ-K11	1403.9509.02
Digital Standard CDMA2000 <sup>®</sup> (with R&S®WinIQSIM™)	R&S®SMJ-K12	1403.9609.02
Digital Standard 3GPP TDD (with R&S®WinIQSIM™)	R&S®SMJ-K13	1403.9709.02
Digital Standard TD-SCDMA (with R&S®WinIQSIM™)	R&S®SMJ-K14	1403.9809.02
User-Defined OFDM Signals (with R&S®WinIQSIM™ and R&S®WinIQOFDM)	R&S®SMJ-K15	1403.9909.02
Digital Standard 1 × EV-DO (with R&S®WinIQSIM™)	R&S®SMJ-K17	1404.0005.02
Digital Standard IEEE 802.11 (a/b/g) (with R&S®WinIQSIM™)	R&S®SMJ-K19	1404.0105.02
Digital Standard 3GPP FDD incl. HSDPA (with R&S®WinIQSIM™)	R&S®SMJ-K20	1404.0205.02
Digital modulation systems using external PC software		
Digital Standard <i>Bluetooth</i> <sup>®</sup>	R&S®SMJ-K5	1404.1301.02
Noise generation		
Additive White Gaussian Noise (AWGN)	R&S®SMJ-K62	1404.0805.02
Other options		
BER/BLER Measurement	R&S®SMJ-K80	1404.0905.02
Rear Connectors	R&S®SMJ-B81	1403.9309.02
<b>Recommended extras</b>		
Hardcopy manuals (in German)		1403.7458.31
Hardcopy manuals (in English, UK)		1403.7458.32
Hardcopy manuals (in English, US)		1403.7458.39
19" Rack Adapter	R&S®ZZA-411	1096.3283.00
Adapter for Telescopic Sliders	R&S®ZZA-T45	1109.3774.00
BNC Adapter for AUX I/O Connector	R&S®SMU-Z5	1160.4545.02
Keyboard with USB Interface (US assignment)	R&S®PSL-Z2	1157.6870.03
Mouse with USB Interface, optical	R&S®PSL-Z10	1157.7060.02
External USB CD-RW Drive	R&S®PSP-B6	1134.8201.12

<sup>1)</sup> The base unit can only be ordered with an R&S®SMJ-B10x option.

<sup>2)</sup> R&S®WinIQSIM™ requires an external PC.

For specifications, see PD 5213.5074.22  
and [www.rohde-schwarz.com](http://www.rohde-schwarz.com)  
(search term: SMJ100A)



**ROHDE & SCHWARZ**

[www.rohde-schwarz.com](http://www.rohde-schwarz.com)

Europe: +49 1805 12 4242, [customersupport@rohde-schwarz.com](mailto:customersupport@rohde-schwarz.com)  
USA and Canada: +1-888-837-8772, [customer.support@rsa.rohde-schwarz.com](mailto:customer.support@rsa.rohde-schwarz.com)  
Asia: +65 65 130 488, [customersupport.asia@rohde-schwarz.com](mailto:customersupport.asia@rohde-schwarz.com)