

PCR-LE SERIES



High-performance multifunctional AC Power Supplies **PCR-LE Series**

- Capable of various power line abnormality simulations and the sequence operation
- Single phase 500 VA to 9 kVA
- Supporting the system for the single-phase, and expandable with optional drivers for the single-phase three-wire, and three-phase operation.
- Expandable capacity up to 27 kVA (single-phase), 54 kVA (single-phase three-line), and 81 kVA (three-phase)
- Features a full range of measuring functions and supports AC, DC, and AC + DC Outputs
- Detachable front panel
- Eco-friendly function equipped
- RS-232C as a standard interface, and GPIB, USB, and LAN (**LXI**) are available as an optional interface.

New stage of AC power supply supporting new energy field

《Smart Grid Vision》

High-performance AC Power Supplies PCR-LE SERIES



The PCR-LE Series is a new line of advanced multifunctional AC power supply that has been developed from our PCR-L/LA Series (linear amplifier type).

The PCR-LE Series provides high reliability and can be applied to various applications, by taking advantage of the features that can control broadband waveform freely. Moreover, the PCR-LE Series can be configured as a core device of a test system combined with E-loads and Power Analyzers for “Grid Connection Testing” in regard to dispersed power generation, such as Solar Power, Wind Power, Fuel Cell, and Gas Engine referred to as “New Energy Field”. With various options, the low frequency immunity test and various power environment tests are supported. The options for parallel operation and three-phase operation enable you to expand a single-phase system up-to 27kVA, single-phase three wires up-to 54kVA, and a three-phase system up to 81kVA. The system can be applied to a large-scale EMC site for testing of industrial high-capacity air conditioners.

9kVA



6kVA



[Applications]

▶ Research & Development

Proof evaluation for power supply abnormality, EMC testing

▶ Adjustment & Inspection Lines

Power supply voltage margin check, Automated inspection system

▶ Production Lines

For stabilizing the line power supply, Automated testing system

▶ Quality Assurance

IEC Standard Testing

▶ After-Sales Service

As power supply for repair and calibration
To reproduce power line abnormalities

AC POWER SUPPLY PCR-LE SERIES

● Lineup

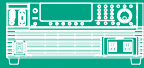
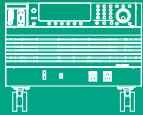
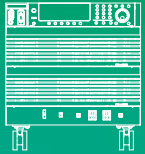
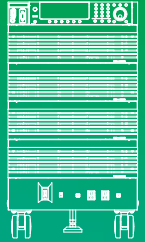
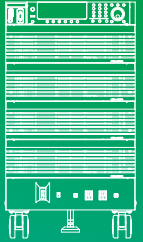
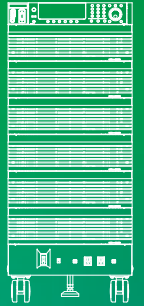
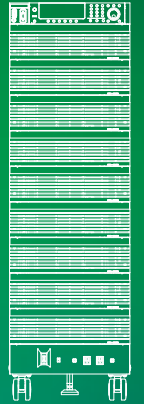
Model	PCR500LE	PCR1000LE	PCR2000LE	PCR3000LE	PCR4000LE	PCR6000LE	PCR9000LE
Output capacity	Single-phase 500VA	Single-phase 1kVA	Single-phase 2kVA	Single-phase 3kVA	Single-phase 4kVA	Single-phase 6kVA	Single-phase 9kVA
Maximum output current (100V/200V)	5A/2.5A	10A/5A	20A/10A	30A/15A	40A/20A	60A/30A	90A/45A
Apparent input power	Approx. 0.93kVA	Approx. 1.8kVA	Approx. 3.6kVA	Approx. 5.5kVA	Approx. 7.3kVA	Approx. 10.6kVA	Approx. 15.7kVA
Input current (100V/200V)	11.3A/5.5A	22A/10.8A	44A/21.5A	66A/32A	88A/43A	64A	55A
Dimensions (mm(inches)) (Maximum dimensions)	430(16.93")W	430(16.93")W	430(16.93")W	430(16.93")(440(17.32"))W	430(16.93")(440(17.32"))W	430(16.93")(440(17.32"))W	430(16.93")(440(17.32"))W
	173(6.81")(195(7.68"))H	262(10.31")(345(13.58"))H	389(15.31")(475(18.70"))H	690(27.17")(785(30.91"))H	690(27.17")(785(30.91"))H	944(36.17")(1040(40.74"))H	1325(52.17")(1420(55.91"))H
	545(21.46")(600(23.62"))D	545(21.46")(595(23.43"))D	545(21.46")(595(23.43"))D	545(21.46")(595(23.43"))D	545(21.46")(595(23.43"))D	545(21.46")(595(23.43"))D	545(21.46")(595(23.43"))D
Weight	Approx. 17kg (37.48lb)	Approx. 35kg (77.16lb)	Approx. 55kg (121.25lb)	Approx. 82kg (180.78lb)	Approx. 96kg (211.64lb)	Approx. 140kg (308.64lb)	Approx. 190kg (418.88lb)
Appearance							

4kVA

3kVA



2kVA



1kVA



500VA



PERFORMANCE

Features and functions

Wide-ranging specs DC output also supported

Output voltage rating (AC)	1 to 300V
Output frequency rating	1 to 999.9Hz
Output voltage rating (DC)	± 1.4 to $\pm 424V$

In addition, the system supports a DC output mode and AC + DC output mode. The system can be useful in a wider range of fields such as chemistry- and physics-related areas.

Selectable response mode

Allows select of a response mode for the internal amplifier system depending on the load condition and application.

High-speed response (FAST)*	for requesting a rate of power rise/fall
Normal response (MEDIUM)	for testing various power supply environments
Highly stable response (SLOW)	for power supply for EMC testing sites

*Excluding PCR6000LE and PCR9000LE

Power line abnormality simulation

In AC mode, it is possible to simulate power line abnormalities by setting the output of the PCR-LE series system to the state of a power outage, voltage drop (dip), or voltage increase (pop). This allows the ability to test switching power supplies and electronic equipment.

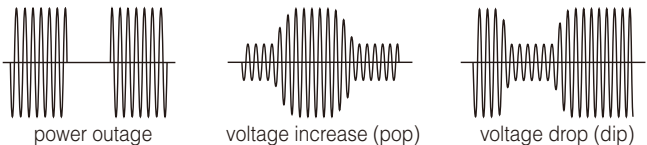

Various measuring functions

Output voltage/current RMS values, peak voltage/current, effective power/apparent power, and power factor can be measured.

It is possible to analyze harmonics (up to 40th order) of the output current.

Sequence function

The output voltage, frequency, and waveform can be changed along the way, thus, power supply environment testing can be automated. In addition to AC output, DC output and AC + DC output in sequence are also available. With the resolution setting by increments of 0.1 ms, the system provides functions to set the starting phase, sudden phase shift, as well as a jump and pause function.

Sensing, Regulation adjustment

Even in cases in which load units are installed remotely, the voltage (RMS value) at the end of the load can be stabilized through correction of voltage drops.

Hardware sensing and software sensing are provided as sensing function, allowing you to selectively use either one accordingly with the load condition and application.

Output current control

The current limiting function enables you to control the output current (RMS) at a certain level for continuous operation by a selectable time setting (time/continuous) for a trip operation. Continuity tests for electric facilities (distribution panels, circuit breakers, devices for wiring, etc.) can be performed under stable conditions.

Eco-friendly function (Power-conservation function)

■ Sleep function

The power unit goes into the sleep mode when no output is detected for a certain time to cut down on the power consumption.

■ Energy-saving operation function*

You can utilize the energy-saving function to operate only the necessary power unit(s) depending on the required supply load.

[Example] Operation with a 4 kVA model when 1 kVA is necessary

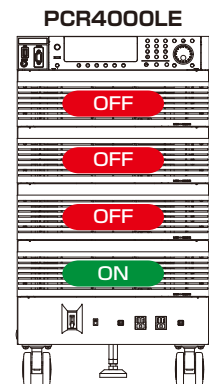

*Excluding PCR500LE and PCR1000LE

External communication

RS232C (equipped as a standard). Remote control available with GPIB, USB, and LAN as options. Using LAN makes it possible to configure highly cost-effective systems, as LXI standard is supported.

Memory function

It is possible to store up to 99 data sets of the output frequency, voltage (AC/DC), and a cyclic waveform under the waveform bank number on the memory of the main unit.

In addition, you can use USB memory devices to store the data contained on the main unit memory, panel settings, power line abnormality simulations, and sequence data.

Standard supported

Usable for systems to test conformance to the IEC61000-3 and 4 Series standards. Optional applications software also offered. Please refer to the end of the brochure for details.

Features and functions

Front panel serving as a remote control

The front panel is detachable. With the optional extension cable, the panel functions as a remote control.

You can operate the PCR-LE unit installed under your work desk/work bench remotely from the front panel connected with the optional extension cable (EC05-PCR).

[Practical example]

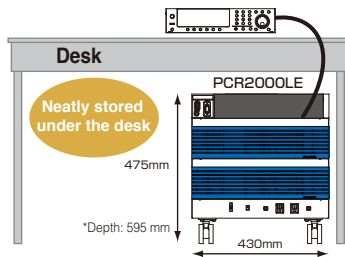

Extension cable for control panel: 2 m [EC05-PCR]

Downsizing

Comparison with the existing PCR-LA (4 kVA)

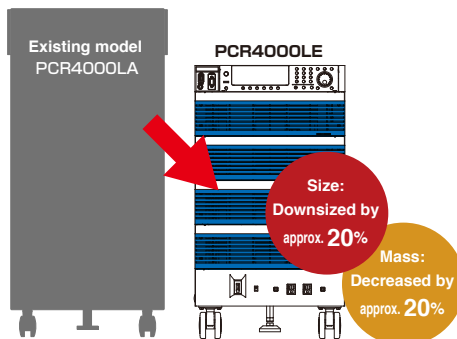

Specifications for large capacity

It is possible to expand to 27 kVA (single phase), 54 kVA (single phase 3-wire), and 81 kVA (three phase) by using the parallel, single phase 3-wire, and three phase operation options (expansion operation drivers). This allows the system to be used for large-scale EMC site power or as test power for large-capacity industrial air conditioners.

- Parallel operation *The separately-sold expansion operation driver is required.
2 kVA or higher model / Max. connectable units: 5 / Max. expansion capacity: Single phase 27 kVA
(Can be expanded to 54 kVA (single phase 3-wire) or 81 kVA (three phase) when used in combination with the single phase 3-wire option or three phase option.)

★ Combinations of different models are possible!

Example: PCR2000LE + PCR4000LE + PCR6000LE = Single phase 12 kVA



- Single phase 3-wire, three phase operation * The separately-sold expansion operation driver is required.

All models / Max. expanded capacity: 54 kVA (single phase 3-wire), 81 kVA (three phase)

(When used in combination with the parallel operation option)

★ Combinations of different models are possible!

Example: PCR2000LE + PCR2000LE + PCR4000LE = Three phase unbalance 8 kVA

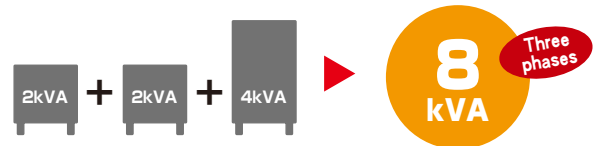

Excellent maintenance ability due to the unit configuration

The PCR-LE series (excluding PCR500LE) are a unit type configuration. The power unit can be serviced (replaced) by the unit of 1 kVA.

For “system interconnection tests” with reverse load flow

Conforming to the guideline for requirements of system interconnection technologies

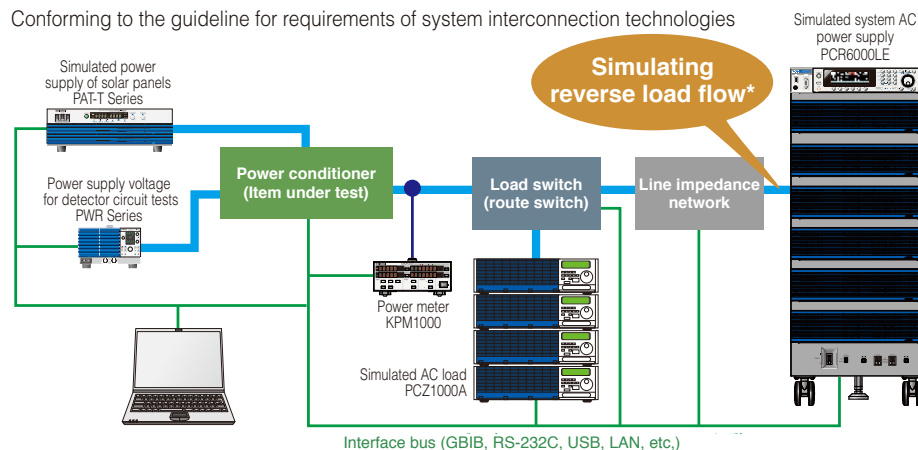

*All the simulated reverse load flow power is consumed internally, thus, there will be no reverse load flow to the system.

Other functions

- Setting output impedance
- Measuring harmonics current
- Soft start (Rise time control)
- Internally fixed Vcc

Specifications

Item/Model	PCR500LE	PCR1000LE	PCR2000LE	PCR3000LE	PCR4000LE	PCR6000LE	PCR9000LE	
Input ratings (AC rms)								
Voltage	85 Vac to 132 Vac, 170 Vac to 250 Vac *1					170 Vac to 250 Vac		
Phases	Single phase						Three phase	
Frequency	47 Hz to 63 Hz							
Apparent power	Approx. 0.96 kVA	Approx. 1.9 kVA	Approx. 3.7 kVA	Approx. 5.6 kVA	Approx. 7.5 kVA	Approx. 11 kVA	Approx. 16kVA	
Power factor *2	0.97 (TYP)							
Max. current *1	11.3 A, 5.5 A	22 A, 10.8 A	44 A, 21.5 A	66 A, 32 A	88 A, 43 A	64 A	55 A	
AC mode output ratings (AC rms)								
Voltage (output L range, output H range)	1 V to 150 V, 2 V to 300 V							
Resolution	0.1V							
Voltage setting accuracy (output L range, output H range) *1	± (0.3 % of set + 0.6V)							
Max. current (output L range, output H range) *2	5 A, 2.5 A	10 A, 5 A	20 A, 10 A	30 A, 15 A	40 A, 20 A	60 A, 30 A	90 A, 45 A	
Phase	Single phase							
Power capacity	500 VA	1 kVA	2 kVA	3 kVA	4 kVA	6 kVA	9 kVA	
Maximum peak current *3	Max. current (rms) × 4							
Max. reverse current *4	30 % of the max. current (rms)							
Load power factor	0 to 1 (leading or lagging) *2							
Frequency *2	1 Hz to 999.9 Hz							
Resolution	0.01 Hz (1.00 Hz to 100.0 Hz), 0.1 Hz (100.0 Hz to 999.9 Hz)							
DC mode output ratings								
Voltage (output L range, output H range)	1.4 V to 212 V, 2.8 V to 424 V							
Resolution	0.1 V							
Voltage setting accuracy (output L range, output H range) *7	± (0.05 % of set + 0.05 V), ± (0.05 % of set + 0.1 V)							
Max. current *8	3.5 A, 1.75 A	7 A, 3.5 A	14 A, 7 A	21 A, 10.5 A	28 A, 14 A	42 A, 21 A	63 A, 31.5 A	
Max. instantaneous current *9	Max. current (rms) × 3.6							
Power capacity	350 W	700 W	1.4 kW	2.1 kW	2.8 kW	4.2 kW	6.3 kW	
Output voltage stability								
Line regulation *10	Within ±0.1 %							
Load regulation (output L range, output H range) *11	Within ±0.1 V, within ±0.2 V							
Output frequency variation *12	FAST	Within ±0.2 %					-	
	MEDIUM	Within ±0.3 %					-	
Ripple noise in DC mode (5 Hz to 1 MHz components)	0.15 Vrms or less	0.15 Vrms or less	0.15 Vrms or less	0.2 Vrms or less	0.2 Vrms or less	0.25 Vrms or less	0.25 Vrms or less	
Ambient temperature variation *13	100 ppm/°C (TYP)							
Output frequency stability, output voltage waveform distortion ratio, output voltage response speed, efficiency								
Output frequency stability *14	Within ±5×10 ⁻⁵							
Setting accuracy	±1×10 ⁻⁴							
Output voltage waveform distortion ratio *15	FAST	±0.2 % or less					-	
	MEDIUM	±0.3 % or less					-	
Output voltage response speed *16	FAST	20 μs (TYP)					-	
	MEDIUM	30 μs (TYP)					-	
Efficiency *17	54 % or more, 56 % or more	55 % or more, 57 % or more				58 % or more		
Meters (fluorescent display)								
Voltmeter *18	Resolution	0.1V						
	Accuracy	± (1 % of rdng + 2 digits)						
Ammeter *18	Resolution	0.01 A	0.01 A	0.01 A	0.1 A	0.1 A	0.1 A	0.1 A
	Accuracy	± (1 % of rdng + 2 digits)						
Wattmeter *19	Resolution	0.1 W, 1 W			1 W			
	Accuracy	± (1 % of rdng + 3 digits)						
Frequency meter	Resolution	0.01 Hz (1.00 Hz to 99.99 Hz), 0.1 Hz (100.0 Hz to 999.9 Hz)						
BNC terminals								
SEQ TRIG OUT *20	Pulse width approx. 10μs, open collector output, pullup at +5 V and approx. 10 kΩ serial resistance approx. 220 Ω, maximum sink current 10 mA, BNC connector							
SEQ STAT OUT *20	Step time output, open collector output, pullup at +5 V and approx. 10 kΩ serial resistance approx. 220 Ω, maximum sink current 10 mA, BNC connector							
SEQ TRIG IN *20	Operating pulse width 10μs or greater, photo-coupler input, driving voltage 5 V, serial resistance approx. 470 Ω, active with 7 mA source, BNC connector							

- *1 100 V input type or 200 V input type
- *2 When the input voltage is 100 V or 200 V, the output voltage is 100 V or 200 V, the output current is the rated value, the load power factor is 1, and the output frequency is between 40 Hz and 999.9 Hz.
- *3 When the output frequency is between 45 Hz and 65 Hz, with no load, and at room temperature.
- *4 When the maximum voltage is between 1 V and 100 V (L range) or 2 V and 200 V (H range) and the load power factor is between 0.8 and 1.
When the output voltage is between 100 V and 150 V (L range) or 200 V and 300 V (H range), the output current is reduced by the output voltage.
When the load power factor is between 0 and 0.8, the output current is reduced by the load power factor.
When the output frequency is between 1 Hz and 40 Hz, the output current is reduced by the output frequency.
- *5 For capacitor-input rectifier loads (however, this is limited by the rated output current's rms value).
- *6 When the output voltage is 100 V or 200 V and the output frequency is between 40 Hz and 999.9 Hz (reverse current is -180 deg out of phase with the output voltage).
- *7 With no load at room temperature
- *8 When the output voltage is between 100 V and 212 V (L range) or 200 V and 424 V (H range), the output current is reduced by the output voltage.
- *9 Limited by the rated output current's rms value
- *10 With respect to changes in the rated range
- *11 With respect to 0 % to 100 % changes in the rating
When the output voltage is between 80 V and 150 V (L range) or 160 V and 300 V (H range) and the load power factor is 1. At the output terminal block. When the response mode is set to FAST or MEDIUM.
- *12 Between 40 Hz and 999.9 Hz.
When the output voltage is between 80 V and 150 V (L range) or 160 V and 300 V (H range) and the load power factor is 1. This is the output line regulation with 200 Hz as the reference.
- *13 With respect to changes in the rated range
When the output voltage range is 100 V or 200 V and the output current is 0 A.
- *14 With respect to changes in all rated ranges
- *15 When the output voltage is between 80 V and 150 V (L range) or 160 V and 300 V (H range) and the load power factor is 1.
- *16 When the output voltage is 100 V or 200 V, the load power factor is 1, and the output current changes from 0 A to the rated value and from the rated value to 0 A.
- *17 When the input voltage is 100 V or 200 V, the output voltage is 100 V or 200 V, the output current is the rated value, the load power factor is 1, and the output frequency is between 40 Hz and 999.9 Hz.
- *18 With the true rms display, a waveform with a crest factor of 3 or less, DC, output frequency between 40 Hz and 999.9 Hz, RMS, and AVE.
- *19 When the output frequency is between 45 Hz and 65 Hz.
- *20 Although signals are insulated with output terminals, each signal is common. Logic setting is also possible.

Specifications

AC POWER SUPPLY PCR-LE SERIES

Item/Model	PCR500LE	PCR1000LE	PCR2000LE	PCR3000LE	PCR4000LE	PCR6000LE	PCR9000LE	
General								
Insulation resistance	Between input and chassis, output and chassis, and input and output			500 Vdc, 30 MΩ or more		500Vdc, 10 MΩ or more		
Withstand voltage	Between input and chassis, output and chassis, and input and output			1.5 kVAC for 1 minute				
Circuit method	Linear amplifier system							
Environmental conditions	Operating environment			Indoor use, overvoltage category II				
	Operating temperature range			0 °C to +50 °C (32 °F to +122 °F)				
	Storage temperature range			-10 °C to +60 °C (14 °F to 140 °F)				
	Operating humidity range			20 % rh to 80 % rh (no condensation)				
	Storage humidity range			90 % rh or less (no condensation)				
Altitude	Up to 2000 m							
Dimensions (chassis)	See the outline drawing.							
Weight	Approx. 17 kg (37.48 lb)	Approx. 35 kg (77.16 lb)	Approx. 55 kg (121.25 lb)	Approx. 82 kg (180.78 lb)	Approx. 96 kg (211.64 lb)	Approx. 140 kg (308.64 lb)	Approx. 190 kg (418.88 lb)	
Input terminal	Inlet	M4	M5	M8	M8	M8	M5	
Output terminal	M4	M4	M4	M5	M5	M8	M8	
Accessories	Power cord	1 pc. With plug Length: 3 m		-				
	User's manual				1 copy			
	Safety information				1 copy			
	CD-ROM				1 disc			
Electromagnetic compatibility (EMC) *1, 2	Complies with the requirements of the following directive and standards. EMC Directive 2004/108/EC EN 61326-1, EN 61000-3-2, EN61000-3-3 The maximum length of all cables and wires connected to the PCR-LE Series must be less than 3 m.							
Safety	*Complies with the requirements of the following directive and standard. Low Voltage Directive 2006/95/EC *2 EN 61010-1 Class I, Pollution Degree 2							

*1 Does not apply to specially ordered or modified PCR-LEs.

*2 Only on models that have the CE marking on the panel.

Output voltage ratio versus rated output current characteristics

The output voltage ratio is a percentage where 100 % represents an output voltage of 100 V (output L range) or 200 V (output H range) in AC mode or DC mode.

The output current ratio is a percentage where 100 % represents the maximum rated output current in AC mode or DC mode.

Output voltage ratio versus rated output current characteristics (AC mode)

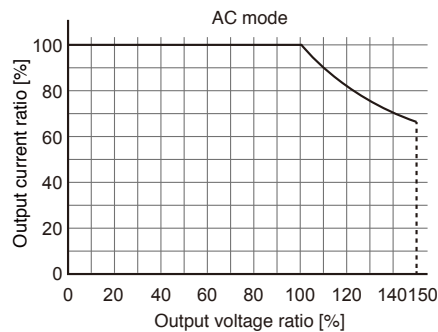

Output voltage ratio versus rated output current characteristics (DC mode)

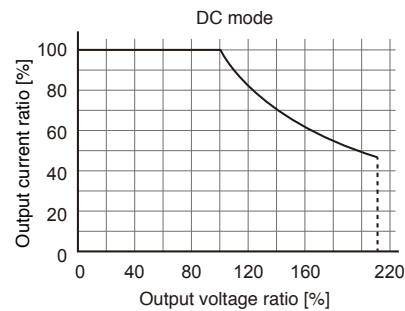

Load power factor versus rated output current characteristics

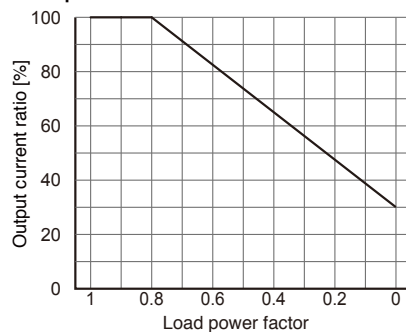

Output frequency versus rated output current characteristics

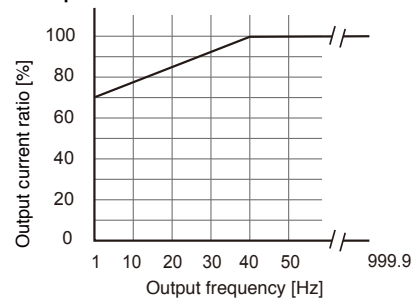

For the "Output voltage ratio versus rated output current characteristics (AC mode)" and "Load power factor versus rated output current characteristics" graphs, the rated output current is the product of output current ratios shown in both graphs. The output current ratio shown in the "Output frequency versus rated output current characteristics" graph is given priority if it is less than the product of output current ratios described above. (This only applies to AC mode.)

List of optional parts

Part	Model	Remarks	
GPIB interface	IB05-PCR-LE		
USB interface	US05-PCR-LE		
LAN interface	LN05-PCR-LE		
Analog interface	EX05-PCR-LE	Available in the near future	
Input power cable	for PCR1000LE	AC5.5-3P3M-M4C	3-core cable 5.5 mm ² /3 m M4
	for PCR2000LE	AC8-1P3M-M5C-3S	3 single-core cables 8 mm ² /3 m M5
	for PCR3000/6000LE	AC14-1P3M-M8C-3S	3 single-core cables 14 mm ² /3 m M8
	for PCR4000LE	AC22-1P3M-M8C-3S	3 single-core cables 22 mm ² /3 m M8
	for PCR9000LE	AC14-1P3M-M5C-4S	4 single-core cables 14 mm ² /3 m M5
Extension cable for control panel	EC05-PCR	2m	
Parallel operation driver (Master)	PD05M-PCR-LE	Available in the near future	
Parallel operation driver (Slave)	PD05S-PCR-LE	Available in the near future	
Single-phase three-wire driver	2P05-PCR-LE	Available in the near future	
Three-phase output driver	3P05-PCR-LE	Available in the near future	
Rack mount Brackets	for PCR500LE	KRB4	For inch-type rack (EIA)
		KRB200	For metric type rack (JIS)
	for PCR1000LE	KRB6	For inch-type rack (EIA)
		KRB300	For metric type rack (JIS)
	for PCR2000LE	KRB9	For inch-type rack (EIA)
	KRB400-PCR-LE	For metric type rack (JIS)	
Base holding angle	OP03-KRC	For fixing PCR3000LE/4000LE/6000LE/9000LE and fixing racks to the floor	
Immunity tester		Available in the near future	
Line impedance network	LIN40MA-PCR-L		
Quick Immunity Sequencer 2	SD009-PCR-LE	Available in the near future	
Software for creating sequences	Wavy for PCR-LE	Available in the near future	

The latest standards for IEC61000-4 supported!

Power Line Disturbance Immunity Testing Software

SD009-PCR-LE

[Quick Immunity Sequencer 2]

Available in the near future

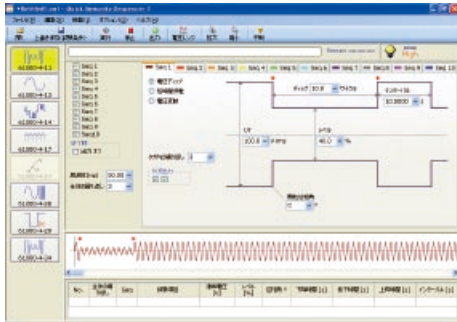

"Quick Immunity Sequencer 2" (model name: SD009-PCR-LE) is an application software for immunity testing with the AC power supply PCR-LE series system, based on the power line disturbance standard (IEC61000-4 Series) for the immunity testing of the EMC standard.

Not only can it be used for compliance testing based on the latest standards or for some types of preliminary testing, but the software can be also employed for advance checking in development phases and for immunity margin tests, because it allows extended testing conditions to be set as needed.

List of conformance to the EMC standard tests

◎ : Conforming as standard
 ○ : Nearly conforming or modification required
 △ : Partially non-conforming
 × : Non-conforming -: Function not available

Standard	Item	Conforming	
		Single-phase	Three-phase
IEC61000-4-11 Voltage dipping, instantaneous power failure and voltage variation	Voltage drop (dip)	○	○
	Instantaneous power failure	○	○
	Voltage variation	◎	◎
	Flat curve	◎	◎
IEC61000-4-13 Higher harmonics wave/interharmonic wave	Over swing	◎	◎
	Frequency sweep	◎	◎
	Odd harmonics the order of which is not a multiple of 3	◎	◎
	Odd harmonics the order of which is a multiple of 3	◎	◎
	Even harmonics	◎	◎
	Interharmonics	◎	◎
	Meister curve	◎	◎
IEC61000-4-14 Voltage swing	Voltage swing	◎	◎
	Interval	◎	◎
IEC61000-4-17 Ripple at the DC input power terminal	Single-phase rectifier circuit	◎	—
	Three-phase rectifier circuit	◎	—
IEC61000-4-27 Unbalance in units	Unbalance	—	◎
IEC61000-4-28 Variation in power supply frequency for units with 16 A/phase	Frequency variation	◎	◎
IEC61000-4-29 Voltage drop (dip), instantaneous power failure and voltage variation in DC	Voltage drop (dip)	◎	—
	Instantaneous power failure	◎	—
	Voltage variation	◎	—
IEC61000-4-34 Voltage drop (dip), instantaneous power failure and voltage variation for units with input current exceeding 16 A/phase	Voltage drop (dip)	△	△
	Instantaneous power failure	△	△
	Voltage variation	○	○

*Immunity testing for units with 16 A/phase except for those required by IEC61000-4-34



KIKUSUI ELECTRONICS CORPORATION

1-1-3, Higashiyamata, Tsuzuki-ku, Yokohama, 224-0023, Japan
Phone: (+81) 45-593-7570, Facsimile: (+81) 45-593-7571, www.kikusui.co.jp

KIKUSUI AMERICA, INC. 1-877-876-2807 www.kikusuiamerica.com

KIKUSUI AMERICA, INC. 530 Lakeside Drive, Suite#180, Sunnyvale, CA 94085, U.S.A.
Phone : 408-733-3432 Facsimile : 408-733-1814

KIKUSUI TRADING (SHANGHAI) Co., Ltd. www.kikusui.cn

KIKUSUI Room, D-01, 11F, Majesty Bld, No.138, Pudong Ave, Shanghai City
Phone : 021-5887-9067 Facsimile : 021-5887-9069

For our local sales distributors and representatives, please refer to "sales network" of our website.

●Distributor/Representative

■ All products contained in this catalogue are equipment and devices that are premised on use under the supervision of qualified personnel, and are not designed or produced for home-use or use by general consumers. ■ Specifications, design and so forth are subject to change without prior notice to improve the quality. ■ Product names and prices are subject to change and production may be discontinued when necessary. ■ Product names, company names and brand names contained in this catalogue represent the respective registered trade name or trade mark. ■ Colors, textures and so forth of photographs shown in this catalogue may differ from actual products due to a limited fidelity in printing. ■ Although every effort has been made to provide the information as accurate as possible for this catalogue, certain details have unavoidably been omitted due to limitations in space. ■ If you find any misprints or errors in this catalogue, it would be appreciated if you would inform us. ■ Please contact our distributors to confirm specifications, price, accessories or anything that may be unclear when placing an order or concluding a purchasing agreement.