

FT68200 Load (4 kW...60 kW)

High-power Programmable DC Electronic Load

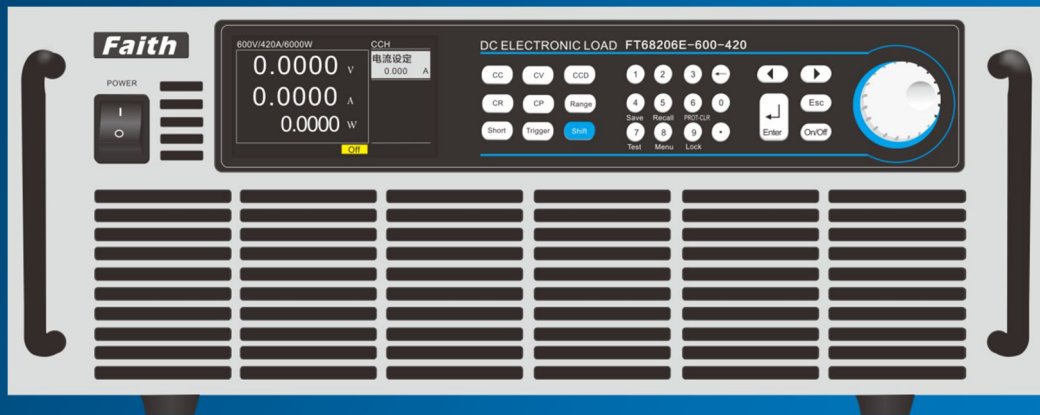

FT68206E 4 kW/600V/280A (4U)

- Voltage range: 150 V, 600 V, 1200 V;
- Current range: 100A/kW (150V), 70A/kW (600V), 40A/kW (1200V), 2400A max. per unit, can be extended to 10000A;
- Rated power: 4kW, 6kW, 8kW, 10kW, 12kW, 18kW, 24kW, 30kW, 36kW, 42kW, 48kW, 54kW, 60kW, max. 600kW (parallel);
- Voltage Accuracy (0.025%+0.025%F.S.), Current Accuracy (0.05%+0.05%F.S.);
- 500kHz sampling speed, 50kHz dynamic current, 30kHz dynamic SWEEP ;
- Readback V/I data transmission rate up to 1000Hz;
- Master-slave parallel operation, power expandable up to 600kW;
- Operation modes CC, CV, CR, CP, CCD, CV+CC, CR+CC, CP+CC;
- Short circuit simulation, instantaneous overpower loading capability;
- OCP, OPP, LED simulation, Load effect, Battery inner resistance & discharge test;
- Time measurement, (Vpk+/-) measurement;
- 20 sequence test files, each with 100 steps, sequence file can be linked
- 50 Auto test files, each with 20 steps, self-starting is allowed
- Voltage-on (Von) & voltage-off (Voff) operation;
- Store and recall up to 20 groups setups;
- Flexible triggering options via front panel, external input, or bus (used for transient test, automatic test);
- Galvanically isolated analog interface provides current programming and monitoring capability ;
- ±OVP, ±OCP, ±OPP, ±LVP, OTP;
- Standard RS232, RS485, LAN, USB (serial), optional GPIB or CAN interface;
- Support SCPI, ModBus and CANopen protocol;

General

FT68200 series high performance high-power DC electronic load provides three voltage ranges 150 V/600 V/1200 V, maximum current 2400 A per single unit, stand-alone power from 4 kW to 60 kW, expandable up to 600 kW, 10000 A by master-slave paralleling. Ultra-high power density, 6kW is with only 4U height. Wider operating region, faster dynamic frequency, as well as transient mode, OCP/OPP test, sequence test, automatic test and battery discharge test functions greatly enhances its test strength and expands application coverage. Furthermore, two times instantaneous overpower loading capability can effectively reduces user's test cost. Built-in standard RS232, RS485, LAN, USB (serial), optional GPIB and CAN interface, supports SCPI, ModBus RTU and CANopen protocol, which facilitates system integrators. FT68200 series has full protection functions, which can be applied to power battery discharge, DC charging station, charging piles, charging pile modules, vehicle On Board chargers (OBC), high-power switching power supplies, power electronics and other power electronics products.

FT68200 Series (4 kW...60 kW)

Transient test

Modern electronic devices operate at very high speeds and demand rapid transient response characteristics. To address these applications, the series offers high speed, programmable dynamic current loading (CCD). The figure shown below exhibits the programmable parameters such as current high/low level, T1/T2, rise/fall rate.

The dynamic loading supports continuous, pulse, and toggle modes. When configured as pulse or toggle mode, the load accepts a trigger signal via front panel, external input, or bus, which allow the dynamic load behavior to be synchronized with other events. The dynamic change is up to 50kHz.

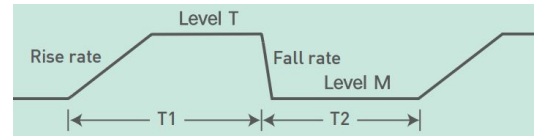

Static test

In addition to the basic test modes of CC, CV, CR, CP, the series load provides users with CV+CC, CP+CC and CR+CC complex modes to meet comprehensive test requirements (complex modes are unavailable for suffix "E" models such as FT68206E).

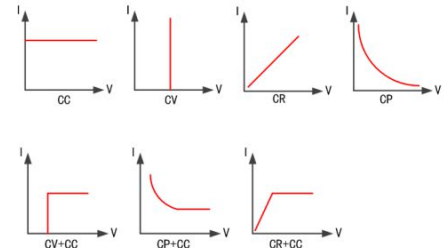

Programmable sequence test

All models provides a programmable sequence function to simulate various load input changes. The sequence feature allows users to program a list of steps to the electronic load's internal memory and execute them. Sequence operates in CCH mode, with max. current slew rate by default. A total of 100 steps can be allocated to each internal memory location, up to a maximum of 20 locations (sequences). The test sequence can be programmed locally through the keypad and knob. Each steps' settings include load value, duration time (100 us ~ 99999 s). Sequence files runs continuously, can be linked to specified sequences, or run for a specified cycles.

30kHz dynamic frequency sweep, $V_{peak (+/-)}$ capture

The FT68200 series load offers a unique dynamic frequency sweep function with variable frequencies up to 30kHz. This capability is ideal for determining worst case voltage peaks. Measurement of the $V_{peak (+/-)}$ can be achieved using this function with a sampling rate of 500kHz. It can effectively test the dynamic response of various power supplies at different frequencies. .

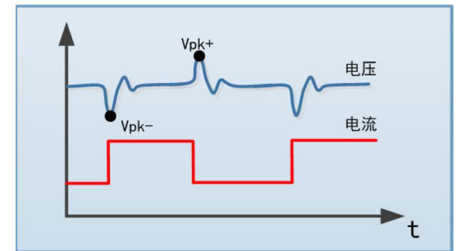

1kHz data transmission rate

The series provides a data transmission rate of up to 1kHz, that is, 1000 voltage and current data points per second, which facilitates applications such as waveform drawing and dynamic data analysis. In system integration applications, the host computer can use this feature for acquiring test data, avoiding the use of oscilloscope and high-speed current acquisition hardware, thus saves costs.

Instantaneous overpower loading capability

All models has an instantaneous load capacity of 2 times the rated power (time range: 5s). This greatly saves costs for instantaneous high-power testing environment. This function is suitable for testing situations such as DC motor start, power supply instantaneous overload, power battery instantaneous high-rate discharge, instantaneous load capacity test of power electronic devices, etc..

Time measurement

All models provide the measurement of rising and falling time of input voltage, current or external level signal. It can be applied to measure the turn on and off time, holding time, rising edge and falling edge time of power supplies. It can also measure the fuse blowing time and circuit breaker response time. The measurement time range is 0.1 ms ~ 20 h, and the resolution is 0.1 ms.

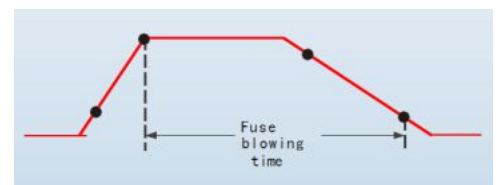

OCP/OPP test

All models provides OCP and OPP test feature, which enables the user to set current or power orders to test overcurrent or overpower protections, also to judge the test result as Pass or Fail on electronic load. The maximum current (I_{max}) or maximum power (P_{max}) during testing can be captured and showed on the display without using an oscilloscope to verify the correctness of designed overcurrent and overpower. It can save a lot of testing time for the user.

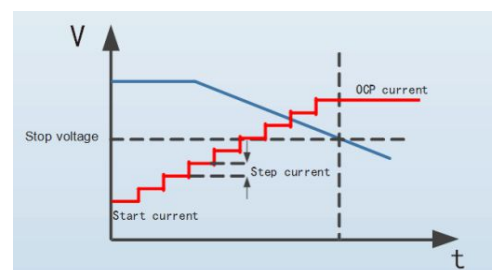

FT68200 Series (4 kW...60 kW)

Automatic test

The principle of the automatic test function is: the load executes the test steps in programmed order according to the automatic test file. In each test step, the load is loaded in specified mode (CC, CV, CR, CP) for a period of time, in the mean time the voltage, current and power are checked to see if they are within the specified range. After running all the test steps, the final result PASS or FAIL is given. In addition, in automatic test the load can accept a trigger signal via front panel, external input, or bus, which allow the test behavior to be synchronized with other events also. FT68200 series load can store up to 50 automatic test files, and each file with up to 20 test steps.

Battery discharge test

The series uses the DC discharge method (DCR) to test the battery internal resistance and capacity. It provides three discharge modes: CC, CR and CP. Users can set the cut-off voltage/time/AH, discharge process shall terminate either condition is satisfied. The load will record the AH, WH and discharge time during the discharge process. This discharge test feature can also apply to super capacitor discharge test.

Voltage-on (Von) & voltage-off (Voff) operation

In static mode (CC, CV, CP and CP) operation, users are able to control the input turn on/off state for the DC electronic load by configuring the Von/Voff function.

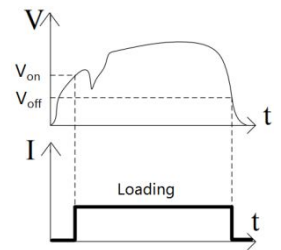

Protective features

For protection of the equipment connected, the load provide programmable protection functions such as OVP, OCP, OPP and LVP. Moreover, there are built-in hardware protection functions OV, OC, OP and OTP. If a protection is triggered, the load will be shut off immediately and a status signal will be prompt on the display

External analog programming and monitoring

In addition to front panel and remote interface control, current values can also be programmed from 0...100% with an analog control signal of 0 V...10 V (available in CCH mode only). To monitor the input current, there are analog outputs with 0 V...10 V. The current programming and monitoring accuracy is 0.5%+0.5%F.S..

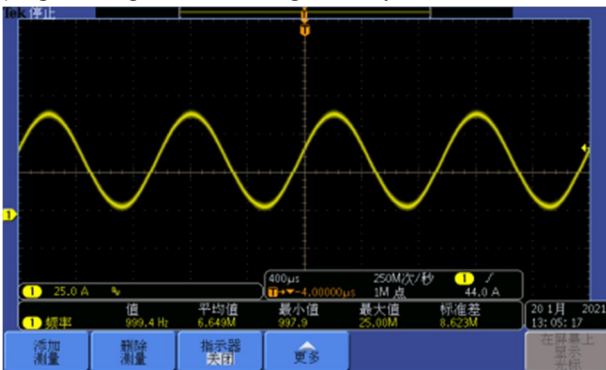

1kHz sine wave

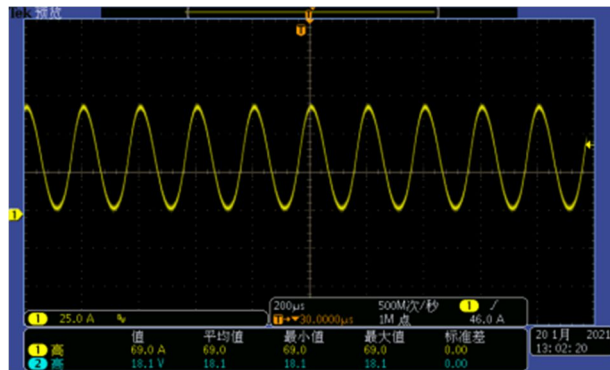

5kHz sine wave

Digital interfaces

In addition to the local controls through full keypad rotary knob, there are standard remote control interfaces such as standard RS232, RS485, LAN, USB (serial), optional GPIB and CAN interfaces. USB, RS232 and LAN can be used to control and monitor the devices either with SCPI language commands or ModBus RTU protocol, while with GPIB only SCPI is supported, with CAN only CANOpen supported.

Master-slave parallel

All models provides the user with smart Master-Slave parallel controls, which enables the user to program the load currents of the Master unit and have them automatically calculated and distributed to the slave loads. For increased power and current, up to 10 identical loads can be run in parallel to achieve the desired power and load current. Using several loads in parallel to simulate a single load dramatically simplifies the operation.

FT68200 Series (4 kW...60 kW)

Optional control software

The series provide a control software for Windows PCs, which can read test data, generate images, export reports, print reports, etc. in real time, it is convenient for customers to use.

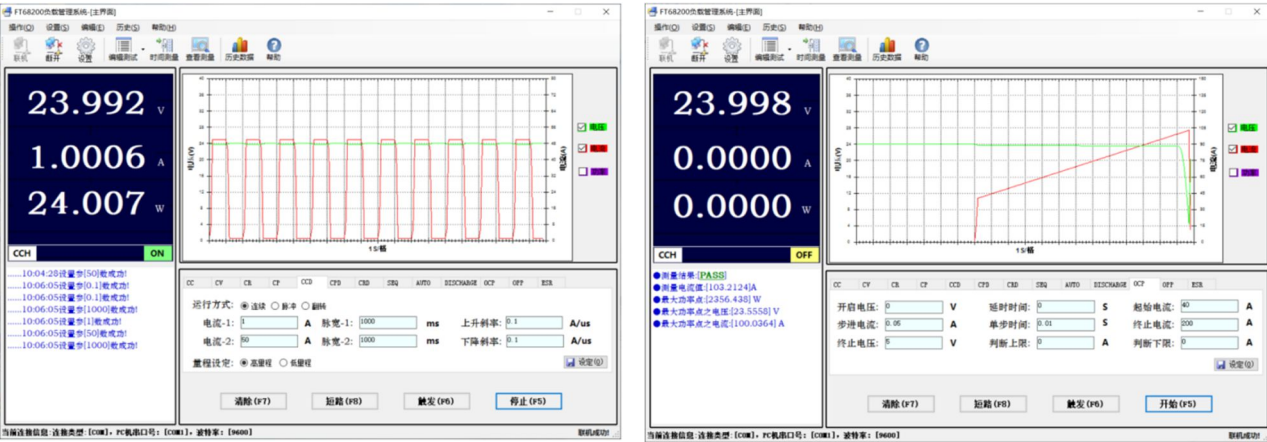

Options

- FT68201A/E graphical visualization control software FaithLoad;
- AC load rectifier accessories;
- Optional digital interfaces such as GPIB, CAN;
- Parallel cable (1 Meter)

Optional accessories table 1

Item	Type name	Notes
Host PC software	FT68201A/E FaithLoad	FT68200A/E host PC software
AC load rectifier accessory	MD220-50	80~260Vac/50A, single phase input
AC load rectifier accessory	MD220-100	80~260Vac/100A, single phase input
AC load rectifier accessory	MD380-100	190~450Vac/100A, 3 phase input
AC load rectifier accessory	MD220-200	190~450Vac/200A, 3 phase input
GPIB interface	FT68201B	
CAN interface	FT68201C	
Parallel cable (1M)	PC010-682	

FT68200 Series (4 kW...60 kW)

Model options

Model Series	Power	150V	600V	1200V	Height*
A series	4KW	FT68204A-150-400	FT68204A-600-280	FT68204A-1200-160	4U
	6KW	FT68206A-150-600	FT68206A-600-420	FT68206A-1200-240	4U
	8KW	FT68208A-150-800	FT68208A-600-560	FT68208A-1200-320	7U
	10KW	FT68210A-150-1000	FT68210A-600-700	FT68210A-1200-400	7U
	12KW	FT68212A-150-1200	FT68212A-600-840	FT68212A-1200-480	7U
	18KW	FT68218A-150-1800	FT68218A-600-1260	FT68218A-1200-720	11U
	24KW	FT68224A-150-2400	FT68224A-600-1680	FT68224A-1200-960	14U
	30KW	FT68230A-150-2400	FT68230A-600-2100	FT68230A-1200-1200	20U
	36KW	FT68236A-150-2400	FT68236A-600-2400	FT68236A-1200-1440	20U
	42KW	FT68242A-150-2400	FT68242A-600-2400	FT68242A-1200-1680	26U
	48KW	FT68248A-150-2400	FT68248A-600-2400	FT68248A-1200-1920	26U
	54KW	FT68254A-150-2400	FT68254A-600-2400	FT68254A-1200-2160	32U
	60KW	FT68260A-150-2400	FT68260A-600-2400	FT68260A-1200-2400	32U
E series	4KW	FT68204E-150-400	FT68204E-600-280	FT68204E-1200-160	4U
	6KW	FT68206E-150-600	FT68206E-600-420	FT68206E-1200-240	4U
	8KW	FT68208E-150-800	FT68208E-600-560	FT68208E-1200-320	7U
	10KW	FT68210E-150-1000	FT68210E-600-700	FT68210E-1200-400	7U
	12KW	FT68212E-150-1200	FT68212E-600-840	FT68212E-1200-480	7U
	18KW	FT68218E-150-1800	FT68218E-600-1260	FT68218E-1200-720	11U
	24KW	FT68224E-150-2400	FT68224E-600-1680	FT68224E-1200-960	14U
	30KW	FT68230E-150-2400	FT68230E-600-2100	FT68230E-1200-1200	20U
	36KW	FT68236E-150-2400	FT68236E-600-2400	FT68236E-1200-1440	20U
	42KW	FT68242E-150-2400	FT68242E-600-2400	FT68242E-1200-1680	26U
	48KW	FT68248E-150-2400	FT68248E-600-2400	FT68248E-1200-1920	26U
	54KW	FT68254E-150-2400	FT68254E-600-2400	FT68254E-1200-2160	32U
	60KW	FT68260E-150-2400	FT68260E-600-2400	FT68260E-1200-2400	32U

* Height excludes casters. All specifications are subject to changes without notice.

Optional accessories table 2: High current test cable matching table

Specification	DC2-2P15M	DC16-2P20M	DC25-2P25M	DC50-2P20M	DC50-2P40M	DC120-2P20M	DC150-2P20M
Max voltage	750V						
Max current	10A	60A	100A	200A	200A	300A	400A
Terminal	M8/Alligator	M8/M8	M8/M8	M8/M8	M8/M8	M8/M8	M10/M10
Cross-sectional area	4.0mm ²	16mm ²	25mm ²	50mm ²	50mm ²	120mm ²	150mm ²
Length	~1.5m	~2m	~2m	~2m	~4m	~2m	~2m

FT68200 Series (4 kW...60 kW)



Specification table -1						
Model	FT68204E-150-400		FT68204E-600-280		FT68204E-1200-160	
Voltage	150V		600V		1200V	
Current	400A		280A		160A	
Power	4,000W		4,000W		4,000W	
U_{Min} for I_{Max}	1.5V/400A		14V/280A		20V/160A	
Constant current						
Range	0-40A	0-400A	0-28A	0-280A	0-16A	0-160A
Resolution	0.7mA	7mA	0.5mA	5mA	0.3mA	3mA
Accuracy	0.05%+0.05%F.S.		0.05%+0.05%F.S.		0.05%+0.05%F.S.	
Constant voltage						
Range	0-30V	0-150V	0-120V	0-600V	0-240V	0-1200V
Resolution	0.5mV	2.5mV	2mV	10mV	4mV	20mV
Accuracy	0.025%+0.025%F.S.		0.025%+0.025%F.S.		0.025%+0.025%F.S.	
Constant power						
Range	0-4,000W		0-4,000W		0-4,000W	
Resolution	60mW		60mW		60mW	
Accuracy	0.2%+0.2% F.S.		0.2%+0.2% F.S.		0.2%+0.2% F.S.	
Constant resistance						
Range	0.014~75Ω	0.14~375Ω	0.08~429Ω	0.8~2143Ω	0.279~1500Ω	2.79~7500Ω
Accuracy	Vin/Rset*(0.2%)+0.2%IF.S		Vin/Rset*(0.2%)+0.2%IF.S		Vin/Rset*(0.2%)+0.2%IF.S	
Dynamic						
T1&T2	10us~60S		10us~60S		10us~60S	
Resolution	2us		2us		2us	
Accuracy	1us+20PPM		1us+20PPM		1us+20PPM	
Current slew rate	0.001~0.4A/us	0.01~4A/us	0.0001~0.26A/us	0.001~2.6A/us	0.0001~0.16A/us	0.001~1.6A/us
Current measurement						
Range	0-40A	0-400A	0-28A	0-280A	0-16A	0-160A
Resolution	0.7mA	7mA	0.5mA	5mA	0.3mA	3mA
Accuracy	0.05%+0.05%F.S.		0.05%+0.05%F.S.		0.05%+0.05%F.S.	
Voltage measurement						
Range	0-30V	0-150V	0-120V	0-600V	0-240V	0-1200V
Resolution	0.5mV	2.5mV	2mV	10mV	4mV	20mV
Accuracy	0.025%+0.025%F.S.		0.025%+0.025%F.S.		0.025%+0.025%F.S.	
Other specs						
AC input	220VAC ±10%, 50~60Hz, 360VA					
Operation temp	0~40°C					
Max power operation	0~25°C					
Weight	40Kg					

FT68200 Series (4 kW...60 kW)

Size	482.6mm(W)*177mm(H)*662.2mm(D)					
Specification table -2						
Model	FT68206E-150-600		FT68206E-600-420		FT68206E-1200-240	
Voltage	150V		600V		1200V	
Current	600A		420A		240A	
Power	6,000W		6,000W		6,000W	
U _{Min} for I _{Max}	1.5V/600A		14V/420A		20V/240A	
Constant current						
Range	0-60A	0-600A	0-42A	0-420A	0-24A	0-240A
Resolution	1mA	10mA	0.7mA	7mA	0.4mA	4mA
Accuracy	0.05%+0.05%F.S.		0.05%+0.05%F.S.		0.05%+0.05%F.S.	
Constant voltage						
Range	0-30V	0-150V	0-120V	0-600V	0-240V	0-1200V
Resolution	0.5mV	2.5mV	2mV	10mV	4mV	20mV
Accuracy	0.025%+0.025%F.S.		0.025%+0.025%F.S.		0.025%+0.025%F.S.	
Constant power						
Range	0-6,000W		0-6,000W		0-6,000W	
Resolution	100mW		100mW		100mW	
Accuracy	0.2%+0.2% F.S.		0.2%+0.2% F.S.		0.2%+0.2% F.S.	
Constant resistance						
Range	0.009~50Ω	0.09~250Ω	0.053~286Ω	0.53~1429Ω	0.186~1000Ω	1.86~5000Ω
Accuracy	Vin/Rset*(0.2%)+0.2%IF.S		Vin/Rset*(0.2%)+0.2%IF.S		Vin/Rset*(0.2%)+0.2%IF.S	
Dynamic						
T1&T2	10us~60S		10us~60S		10us~60S	
Resolution	2us		2us		2us	
Accuracy	1us+20PPM		1us+20PPM		1us+20PPM	
Current slew rate	0.001~0.6A/us	0.01~6A/us	0.0001~0.4A/us	0.001~4A/us	0.0001~0.24A/us	0.001~2.4A/us
Current measurement						
Range	0-60A	0-600A	0-42A	0-420A	0-24A	0-240A
Resolution	1mA	10mA	0.7mA	7mA	0.4mA	4mA
Accuracy	0.05%+0.05%F.S.		0.05%+0.05%F.S.		0.05%+0.05%F.S.	
Voltage measurement						
Range	0-30V	0-150V	0-120V	0-600V	0-240V	0-1200V
Resolution	0.5mV	2.5mV	2mV	10mV	4mV	20mV
Accuracy	0.025%+0.025%F.S.		0.025%+0.025%F.S.		0.025%+0.025%F.S.	
Other specs						
AC input	220VAC ±10%, 50~60Hz, 360VA					
Operation temp	0~40°C					
Max power operation	0~25°C					
Weight	40Kg					
Size	482.6mm(W)*177mm(H)*662.2mm(D)					

FT68200 Series (4 kW...60 kW)

Specification table -3						
Model	FT68212E-150-1200		FT68212E-600-840		FT68212E-1200-480	
Voltage	150V		600V		1200V	
Current	1200A		840A		480A	
Power	12,000W		12,000W		12,000W	
U_{Min} for I_{Max}	1.5V/1200A		14V/840A		20V/480A	
Constant current						
Range	0-120A	0-1200A	0-84A	0-840A	0-48A	0-480A
Resolution	2mA	20mA	1.4mA	14mA	0.8mA	8mA
Accuracy	0.05%+0.05%F.S.		0.05%+0.05%F.S.		0.05%+0.05%F.S.	
Constant voltage						
Range	0-30V	0-150V	0-120V	0-600V	0-240V	0-1200V
Resolution	0.5mV	2.5mV	2mV	10mV	4mV	20mV
Accuracy	0.025%+0.025%F.S.		0.025%+0.025%F.S.		0.025%+0.025%F.S.	
Constant power						
Range	0-12,000W		0-12,000W		0-12,000W	
Resolution	200mW		200mW		200mW	
Accuracy	0.2%+0.2% F.S.		0.2%+0.2% F.S.		0.2%+0.2% F.S.	
Constant resistance						
Range	0.005~25Ω	0.05~125Ω	0.027~143Ω	0.27~714Ω	0.093~500Ω	0.93~2500Ω
Accuracy	$V_{in}/R_{set}*(0.2\%)+0.2\%IF.S.$		$V_{in}/R_{set}*(0.2\%)+0.2\%IF.S.$		$V_{in}/R_{set}*(0.2\%)+0.2\%IF.S.$	
Dynamic						
T1&T2	10us~60s		10us~60s		10us~60s	
Resolution	2us		2us		2us	
Accuracy	1us+20PPM		1us+20PPM		1us+20PPM	
Current slew rate	0.001~1.2A/us	0.01~12A/us	0.0001~0.8A/us	0.001~8A/us	0.0001~0.48A/us	0.001~4.8A/us
Current measurement						
Range	0-120A	0-1200A	0-84A	0-840A	0-48A	0-480A
Resolution	2mA	20mA	1.4mA	14mA	0.8mA	8mA
Accuracy	0.05%+0.05%F.S.		0.05%+0.05%F.S.		0.05%+0.05%F.S.	
Voltage measurement						
Range	0-30V	0-150V	0-120V	0-600V	0-240V	0-1200V
Resolution	0.5mV	2.5mV	2mV	10mV	4mV	20mV
Accuracy	0.025%+0.025%F.S.		0.025%+0.025%F.S.		0.025%+0.025%F.S.	
Other specs						
AC input	220VAC ±10%, 50~60Hz, 720VA					
Operation temp	0~40°C					
Max power operation	0~25°C					
Weight	72Kg					
Size	482.6mm(W)*310mm(H)*712.2mm(D)					

FT68200 Series (4 kW...60 kW)

Specification table -						
Model	FT68224E-150-2400		FT68224E-600-1680		FT68224E-1200-960	
Voltage	150V		600V		1200V	
Current	2400A		1680A		960A	
Power	24,000W		24,000W		24,000W	
U_{Min} for I_{Max}	1.5V/2400A		14V/1680A		20V/960A	
Constant current						
Range	0-240A	0-2400A	0-168A	0-1680A	0-96A	0-960A
Resolution	4mA	40mA	2.8mA	28mA	1.6mA	16mA
Accuracy	0.05%+0.05%F.S.		0.05%+0.05%F.S.		0.05%+0.05%F.S.	
Constant voltage						
Range	0-30V	0-150V	0-120V	0-600V	0-240V	0-1200V
Resolution	0.5mV	2.5mV	2mV	10mV	4mV	20mV
Accuracy	0.025%+0.025%F.S.		0.025%+0.025%F.S.		0.025%+0.025%F.S.	
Constant power						
Range	0-24,000W		0-24,000W		0-24,000W	
Resolution	400mW		400mW		400mW	
Accuracy	0.2%+0.2% F.S.		0.2%+0.2% F.S.		0.2%+0.2% F.S.	
Constant resistance						
Range	0.002~13Ω	0.02~63Ω	0.013~71Ω	0.13~357Ω	0.046~250Ω	0.46~1250Ω
Accuracy	$V_{in}/R_{set}*(0.2\%)+0.2\%F.S.$		$V_{in}/R_{set}*(0.2\%)+0.2\%F.S.$		$V_{in}/R_{set}*(0.2\%)+0.2\%F.S.$	
Dynamic						
T1&T2	10us~60s		10us~60s		10us~60s	
Resolution	2us		2us		2us	
Accuracy	1us+20PPM		1us+20PPM		1us+20PPM	
Current slew rate	0.001~2.4A/us	0.01~24A/us	0.001~1.6A/us	0.01~16A/us	0.001~0.96A/us	0.01~9.6A/us
Current measurement						
Range	0-240A	0-2400A	0-168A	0-1680A	0-96A	0-960A
Resolution	4mA	40mA	2.8mA	28mA	1.6mA	16mA
Accuracy	0.05%+0.05%F.S.		0.05%+0.05%F.S.		0.05%+0.05%F.S.	
Voltage measurement						
Range	0-30V	0-150V	0-120V	0-600V	0-240V	0-1200V
Resolution	0.5mV	2.5mV	2mV	10mV	4mV	20mV
Accuracy	0.025%+0.025%F.S.		0.025%+0.025%F.S.		0.025%+0.025%F.S.	
Other specs						
AC input	220VAC ±10%, 50~60Hz, 1420VA					
Operation temp	Ambient temperature 0~40°C					
Max power operation	Ambient temperature 0~25°C					
Weight	156Kg					
Size	482.6mm(W)*621mm(H)*712.2mm(D)					

* All specifications are subject to changes without notice.

1. Meet the rated specifications in ambient temperature range of 25±5°C.
2. If the working voltage exceeds 1.05 times of the rated voltage, it may cause permanent damage to the device.

FT68200 Series (4 kW...60 kW)

A/E type model differences

Function list	Model type A	Model type E
Constant current (CCH/CCL)	√	√
Constant voltage (CVH/CVL)	√	√
Constant resistance (CR)	√	√
Constant power (CP)	√	√
Dynamic current (CCDH/CCDL)	√	√
Dynamic resistance (CRD)	√	
Dynamic power (CPD)	√	
Sequence (SEQ)	√	√
Auto test (Auto)	√	√
Over current protection (OCP)	√	√
Over power protection (OPP)	√	√
Discharge test (DISCHARGE)	√	√
Load effect test (LOEF)	√	√
Internal resistance test (ESR)	√	√
LED simulation (LED)	√	
Dynamic frequency sweep	√	√
CV+CC	√	
CR+CC	√	
CP+CC	√	
Memory	√	√
Quick Recall	√	√
Remote sense compensation	√	√
Constant current speed	√	√
Analog programming	√	√
External control	√	√
Short circuit simulation	√	√
Timed loading	√	√
VON/VOFF	√	√
Limit setting	√	√
Hardware limit	√	√
Protection settable	√	√
Time measurement	√	√
Vpk+/-	√	√
Data transmission	1kHz/s	1kHz/s
Parallel	√	√
Communication ports	RS232/RS485/LAN/USB (GPIB, CAN optional)	RS232/RS485/LAN/USB (GPIB, CAN optional)

FT68200 Series (4 kW...60 kW)

Protocol	SCPI, ModBus	SCPI, ModBus
----------	--------------	--------------

Dimension

4U height model (6kW)

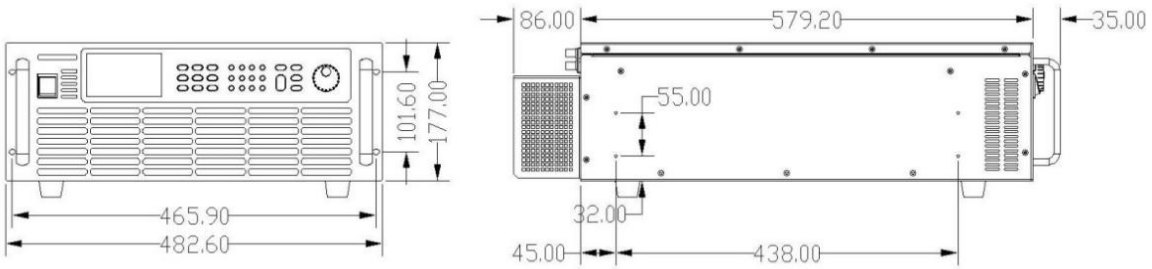

7U height model (8kW~12kW) dimension

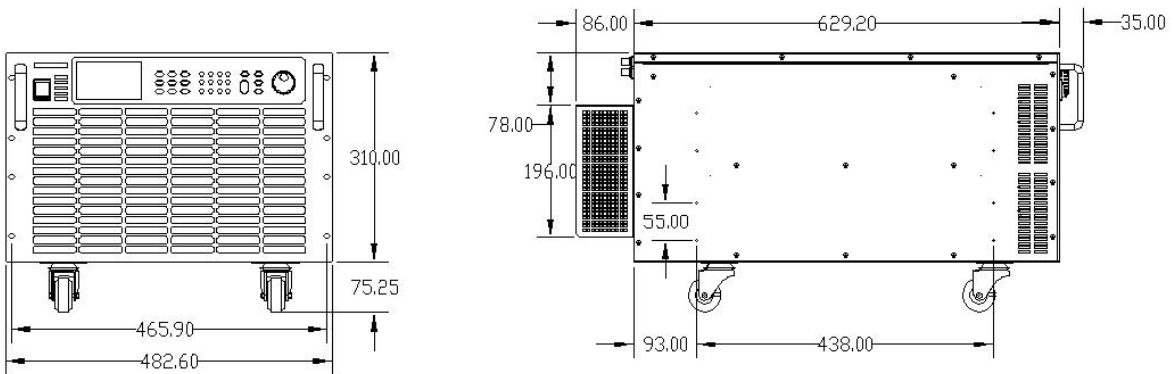

14U height model (20kW~24kW) dimension

