

*Signal***Explorer**

Digital Oscilloscope
DL1740

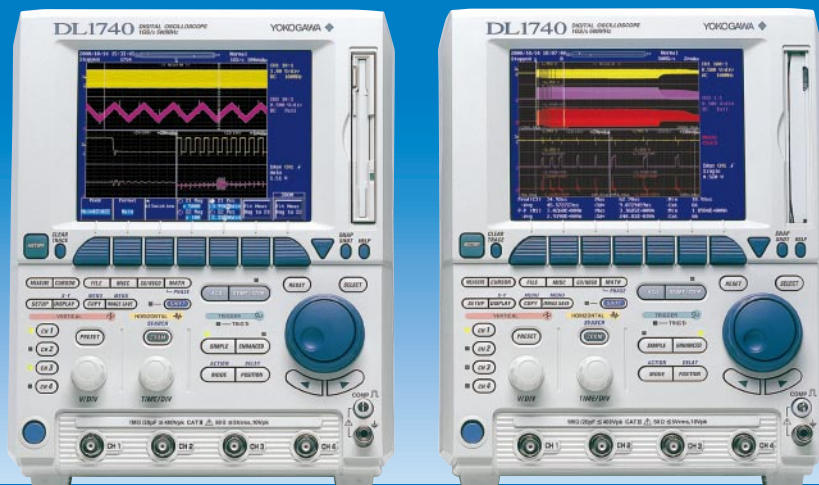

- 1 GS/s ● 500 MHz analog bandwidth ● 1MW memory length
- 6.4-inch wide-angle-view TFT color LCD ● Compact and lightweight (approx. 5.5 kg)
- A4-size footprint ● Newly developed DSE chip for high-speed screen updating
- Built-in Zip® drive or FDD ● USB-compliant ● Ethernet-connectivity (optional)
- Search functions (History Search & Zoom) ● Easy to use



Signal Explorer

The most advanced Compact Waveform Analysis solution available today!



- **Fast sampling**
1 GS/s for real-time sampling
100 GS/s for equivalent-time sampling
- **Wide frequency bandwidth**
500 MHz

- **Long record length**
1 MW maximum.
- **Wide choice of triggers**
- **Built-in Zip® drive**
Supports 100/250 MB Zip® disks-as an alternative to a floppy disk drive

- **USB Compliant**
USB keyboard/printer
- **Built-in printer (optional)**
- **Ethernet interface (optional)**

Our oscilloscope design focuses on the following two points:

- Easy and accurate capturing of complex signals;
 - High-speed extraction and screen display of desired information from large volumes of captured data.
- Here are the features packed into the DL1740 to bring these design concepts into reality:

Large recording memory and easy-to-use zoom functions for precise waveform capturing and viewing

Even a measuring instrument with higher sampling performance may fail to precisely capture waveforms, depending on the time interval of observation. This failure results from a decrease in the effective sampling rate due to shorter record lengths of memory. Large recording memory not only helps extend the observation time interval but prevents the sampling rate from degrading. This allows correct waveform observation. Using the zoom functions along with the large recording memory enables you to scrutinize part of a waveform you've caught into the memory. You can set two zoom-in areas at the same time.

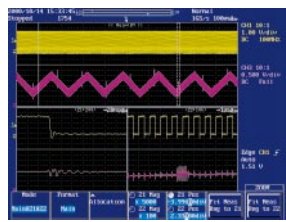
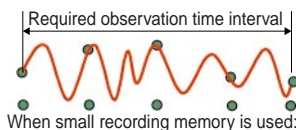

All-points display and fast screen updating for reliably capturing abnormal phenomena

Information available from data significantly differs depending on the view mode even if the data is captured into the same large recording memory. This is due to a difference between display modes, i.e., whether the oscilloscope displays all of the data items the captured waveform has or only representative data items, such as interval-by-interval minimums and maximums.

Provided with the DSE chip, the DL1740 replays all-points waveforms while performing fast screen updates. Therefore, the DL1740 does not have the usual problems associated with large recording memory such as missing abnormal phenomena or poor key response.

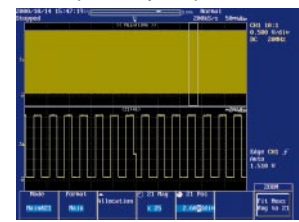
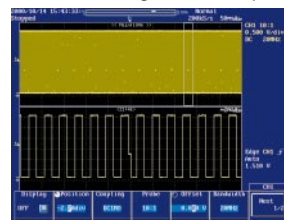

Smart Search functions for finding only the necessary data among massive amounts of complex data

Search & Zoom



The Search & Zoom functions automatically selects the desired pattern of a signal from captured data and allows you to zoom in on it.

- From given data, find parts of a waveform that match the targeted serial or parallel pattern you've set. Then, show them in a Zoom window. —**Pattern search**
- Define the pulse width (with a high or low state) to find pulses of your interest. You can define the pulse width using one of four options: Pulse < T, Pulse > T, T1 < Pulse < T2, and Timeout. —**Pulse width search**
- Count rising and falling edges to detect edges of your interest. —**Edge search**
- Automatically scroll through the zoomed-in area. —**Auto-scroll**

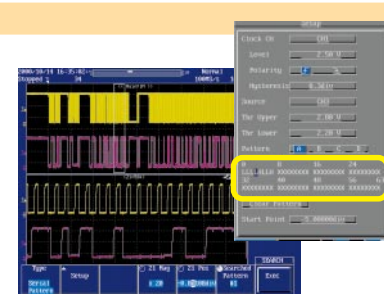

History Memory and History Search



Even if you press the STOP key as soon as you capture any abnormal waveform, you are too late in most cases. You'll find the waveform has already been updated and gone from the screen. The **History Memory** function partitions the large recording memory into multiple blocks. Thus, the DL1740 automatically retains data of up to 2048 screens. For 100 KW observation, the oscilloscope can retain 32 screens' worth (approximately 1 second) of waveform data. You can reliably save on-screen waveforms in memory even for phenomena for which you cannot set trigger conditions. What's more, you can use the **History Search** function to automatically identify abnormal waveforms within the history memory.

- **Zone search:** You can set a zone in a window to detect only those waveforms part of which transits (Pass) or does not transit (Bypass) through the zone. You can set a maximum of four zones.
- **Parameter search:** You can set a parameter value to detect only those waveforms whose relevant parameter matches the preset value. You can set a maximum of four parameter values.

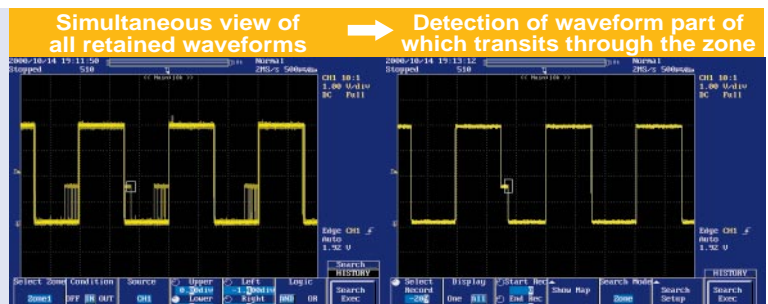
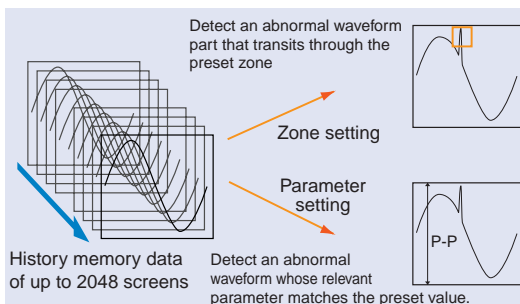

The compact oscilloscope comes packed with a wide choice of functions

Automatic measurement of waveform parameters

The DL1740 automatically measures the voltage level, frequency and RMS values of a waveform. It comes standard with the following functions, in addition to typical parameters.

Pulse count

Automatically calculates and indicates the pulse count for a range of waveform defined by the cursors.

This function is useful for counting interrupt signals, pulse signal from stepping motors and so on.

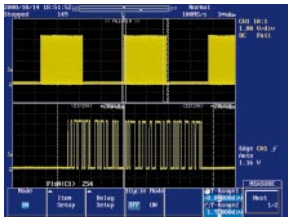

Dual area measurement

Allows you to set two areas of waveform parameter measurement at the same time.

This function is useful for comparing the overshoot at another area by a numerical value.

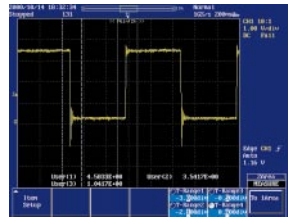

Parameter computing

Allows you to perform dyadic operations using waveform parameters and constants.

This function is useful for real-time adjustment of gain.



Cycle statistics

Allows you to measure the parameters of a long-time signal, cycle by cycle, that was captured into long-record-length memory. You can also take statistical measurements (maximum, minimum, average, number of the signal's cycles, and standard deviation) for cycles within a selected interval.

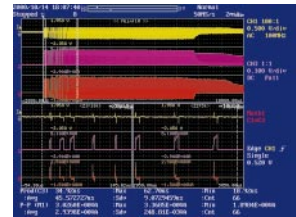

Envelope and Roll modes for simultaneously observing both slow and fast signals

Envelope mode always captures signals at the highest sampling rate, irrespective of the time-axis setting. This mode is effective when observing high-frequency noise superposed on a slow signal.

Roll mode allows you to observe signals on the screen in much the same way as you record them on a recorder chart. When in normal mode, you can set the sampling rate as high as 2 MS/s for roll mode. In addition, you can have a roll-mode view of signals in the envelope mode.

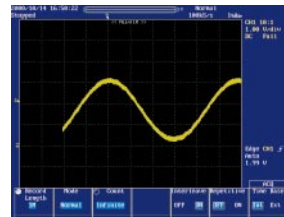

Roll-mode View in Normal Mode

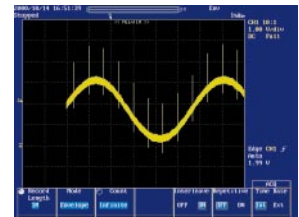

Roll-mode View in Envelope Mode

Simple and enhanced triggers for reliably capturing a variety of waveforms

Having a wide choice of triggers is extremely effective for consistently observing a variety of waveforms.

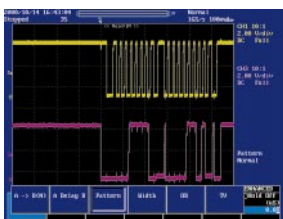

SIMPLE ENHANCED

- Edge: normal trigger enabled by an edge.
- A → B (N): trigger enabled when condition B becomes true Nth time after condition A becomes true.
- A Delay B: trigger enabled when condition B becomes true first time after a preset time has elapsed since condition A became true
- Pattern: trigger enabled when after setting its conditions channel by channel, the combined conditions are made true by the given edge of a clock-channel pulse.
- Pulse Width: trigger enabled when a preset condition becomes true as the result of comparing an input pulse width with a specified time length.
(Pulse > Time, Pulse < Time, T1 < Pulse < T2, and Timeout)
- OR: trigger enabled when any of the conditions of two or more trigger sources becomes true.
- TV: trigger enabled by an NTSC or PAL signal.

Snapshot

The DL1740 retains the current on-screen waveform when you press the SNAPSHOT key on the panel just like triggering a camera shutter. The retained waveform stays on the screen until you press the CLEAR key. This feature is useful when comparing the waveform with the input waveform. What's more, you can save the snapshot and read it later.

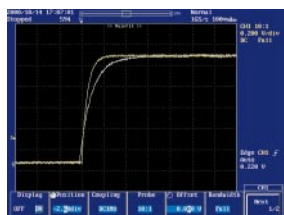

GO/NO GO Judgment — Automatic Waveform Discrimination —

Select zones or parameters for the waveform of an acquired signal. The DL1740 judges the signal being measured and automatically takes action. Actions you can choose from include: outputting image data to the destination specified in the Copy Setup menu, saving waveform data in the medium specified in the File menu, sounding the buzzer, and sending e-mail.

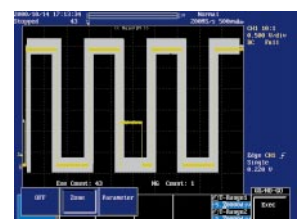

Excellent hook-up to a personal computer

USB Interface

Link with Personal Computer (to be supported soon)

You can easily connect the DL1740 to your personal computer by combining the oscilloscope with the software "Waveform Viewer for DL Series." Then, you can acquire and save waveform and image data into the computer.

Connection to keyboard/printer

The DL1740 supports USB keyboards and printers. You can input file names and comments from your USB keyboard or output hardcopies of on-screen images to your USB printer.



Easy and Quick Saving of Images

Just press the **IMAGE SAVE** key. The DL1740 saves on-screen images to a storage medium, such as a Zip® drive. With the **COPY** key, you can output the images to the built-in printer.



Ethernet Function (Optional)

Data Transfer

As an FTP server, the DL1740 lets you have access from your personal computer to download data to a floppy or Zip® drive.

As an FTP client, the DL1740 lets you save waveform data in your personal computer and download data from the computer. Furthermore, you can save images and setup data in the computer.

Network Printing

You can output hardcopies of on-screen images to a remote network printer.

E-mail Sending

You can send e-mail periodically to the address you select. E-mail sending is also possible as an action triggered by the GO/NO GO judgment function.

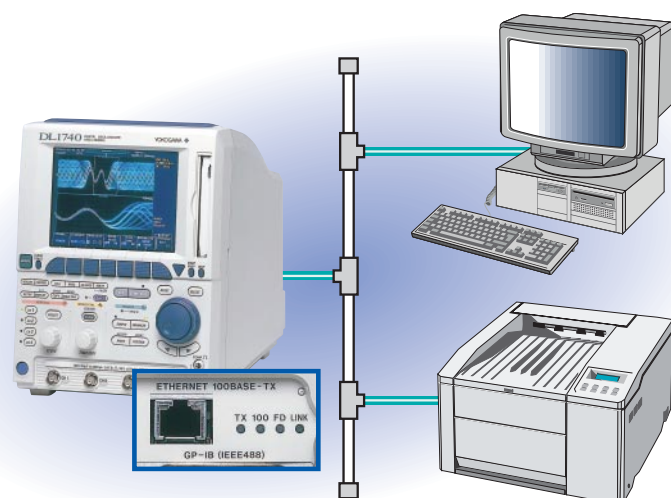

Rear Panel Layout

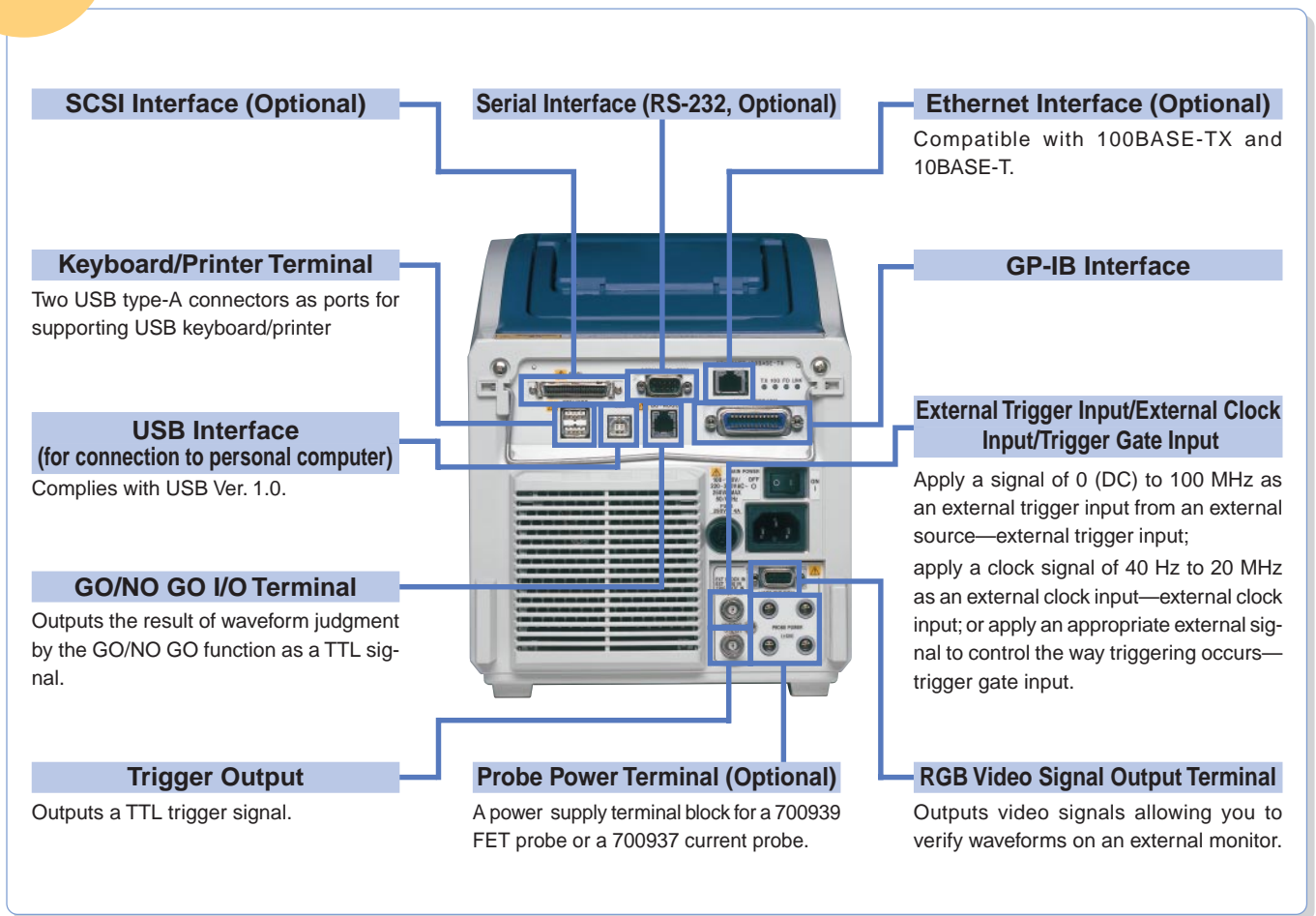

Accessories



700988 Passive Probe



700939 FET Probe



700924 100-MHz Differential Probe



700937 Current Probe

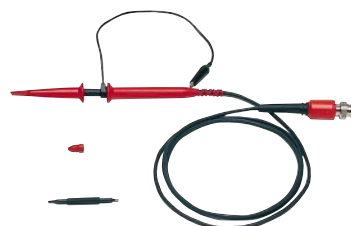

700978 100:1 Probe

Performance/Function Specifications

Basic Specifications

Input coupling:	AC-1 M Ω , DC-1 M Ω , DC-50 Ω , GND
Input impedance:	1 M Ω \pm 1.0%, 50 Ω \pm 1.0%
Voltage-axis sensitivity range:	<ul style="list-style-type: none"> • 50-Ω input: 2 mV—1 V/div (in 1, 2 or 5 mV increments) • 1-MΩ input: 2 mV—10 V/div (in 1, 2 or 5 mV increments)
Maximum input voltage:	<ul style="list-style-type: none"> • 1-MΩ input (at 1 kHz or less frequencies): 400 V (DC + AC peak)—282 Vrms CAT II • 50-Ω input: 5 Vrms max. and 10 Vpeak max.
Frequency characteristics ¹ (-3 dB roll-off point for sine-wave input with \pm 4 div amplitude):	<ul style="list-style-type: none"> • 50-Ω input: 1 V—10 mV/div over 0 (DC) to 500 MHz, or 5 mV—2 mV/div over 0 (DC) to 400 MHz • 1-MΩ input (defined as resistance up to the probe tip when 700988 passive probe is used): 10 V—10 mV/div over 0 (DC) to 400 MHz, or 5 mV—2 mV/div over 0 (DC) to 300 MHz
A/D conversion resolution:	8 bits (24 LSBs/div)
Maximum sampling rate:	<ul style="list-style-type: none"> • Real-time sampling mode When interleave mode is on: 1 GS/s² When interleave mode is off: 500 MS/s • Equivalent-time sampling mode: 100 GS/s • When interleave mode is on: 1 MW² • When interleave mode is off: 500 KW
Maximum record length:	<ul style="list-style-type: none"> • 1 ns—50 s/div (for 10-KW or longer record length) • 1 ns—5 s/div (for 1-KW record length)
DC-mode accuracy ¹ :	\pm (1.5% of 8 divisions + voltage-axis offset accuracy)
Voltage-axis offset accuracy ¹ :	<ul style="list-style-type: none"> • 2 mV—50 mV/div: \pm(1% of setpoint + 0.2 mV) • 100 mV—500 mV/div: \pm(1% of setpoint + 2 mV) • 1 V—10 V/div: \pm(1% of setpoint + 20 mV)
Sweep time:	<ul style="list-style-type: none"> • 1 ns—50 s/div (for 10-KW or longer record length) • 1 ns—5 s/div (for 1-KW record length)
Timebase accuracy ¹ :	\pm 0.005%
External clock input:	Within the 40 Hz—20 MHz input frequency range (for continuous clock signals only)

Trigger Block

Trigger mode:	AUTO, AUTO-LEVEL, NORMAL, SINGLE, SINGLE (N)
Trigger source:	CH1 to CH4 (signal applied to each input terminal), LINE (signal of commercial power source connected to DL1740), EXT (signal input to EXT TRIG IN terminal)
Types of trigger:	Edge, A \rightarrow B (N), A Delay B, OR, Pattern, Pulse Width, TV

Display

Screen updating rate:	<ul style="list-style-type: none"> • 60 screens/s max. (for 10-KW, all-points view mode) • 30 screens/s max. (for 1-MW, all-points view mode)
Display unit:	6.4-in. TFT color LCD

Functions

● Vertical/Horizontal Axis Setting Functions	
Input filter:	Bandwidth can be limited to 100 MHz or 20 MHz for each of channels CH1 through CH4 separately.
Roll mode:	Roll-mode view is enabled for the following range of timebase setpoints when the trigger mode is Auto, Auto Level or Single: 50 ms to 50 s/div (or 50 ms to 5 s/div for 1-KW record length only)
● Waveform Acquisition/Display Functions	
Acquisition mode:	Normal, Averaging, Envelop, Box Average

Zoom:	Zooms in on an on-screen waveform along the timebase. (This function is available for up to two areas of the waveform, each with a different magnification.)
X-Y display:	Available in two waveform view modes—XY1 and XY2.

● Analysis Functions

Search and Zoom:	Edge, Serial Pattern, Parallel Pattern, Pulse Width, Auto Scroll
History Search:	Zone, Parameter
Cursor measurements :	Marker, Horizontal, Vertical, Degree
Automatic waveform parameter measurement:	P-P, Max, Min, High, Low, Avg, Rms, +OShot, -OShot, Sdev, Rise, Fall, Freq, Period, Duty, +Width, -Width, Int1TY, Int2TY, Int1XY, Int2XY, Pulse, Burst1, Burst2, AvgFreq, AvgPeriod. In addition, the following statistical processing is possible: <ul style="list-style-type: none"> • Supported data items: Above-listed parameters • Statistical data items: Min, Max, Avg, Cnt, Sdv • Statistics mode: Normal, Cycle, History
Computation:	+ , - , \times , Binarization, Differentiation, Integration, Power Spectrum, Invert
GO/NO GO judgment:	Executed by means of automatically measured waveform parameters and waveform zones
● Image Data Output	
Built-in printer (optional):	Provides hardcopies of on-screen images using 112-mm wide print paper.
External printer:	Outputs the image data through a USB interface or via Ethernet ³ . This function supports : Postscript, ESC/P, ESC/P2, LIPS3, PCL5 and BJ commands.
Floppy/Zip [®] /SCSI-drive output data formats:	Postscript, TIFF, BMP
Network drive (via Ethernet ³):	

Rear-panel I/O Block

Communication interfaces:	GP-IB, Keyboard/Printer ports (for USB keyboard/printer), USB (Ver. 1.0, for connection to personal computer), Ethernet (100BASE-TX and 10BASE-T, optional), SERIAL (RS-232, optional), SCSI (optional)
Signal I/Os:	External trigger input/external clock input/trigger gate input, trigger output, RGB video signal output, GO/NO GO I/O
Probe power terminal (optional):	<ul style="list-style-type: none"> • Number of outlets: 4 • Output voltage: \pm12 V

General Specifications

Source voltage:	100 to 120 V AC / 220 to 240 V AC (switches automatically)
Power supply frequency:	50/60 Hz
Maximum power consumption:	200 VA
External dimensions:	220 (W) \times 265.8 (H) \times 264.1 (D) (mm) 8.66 (W) \times 10.46 (H) \times 10.40 (D) (inch) (when measured with the printer cover shut in place and protrusions and the handle excluded)
Weight:	Approx. 6 kg (13.23 lbs; including the printer), or Approx. 5.5 kg (12.13 lbs; excluding options)
Operating temperature range:	5—40 $^{\circ}$ C

^{*1} Measured with the timebase set to the internal clock, after the DL1740 under test has been warmed up under the following standard operating conditions and then calibrated.
Standard operating conditions:

- Ambient temperature: 23 \pm 2 $^{\circ}$ C
- Ambient humidity: 55 \pm 10%RH
- Supply-voltage/frequency errors: 1% max. of ratings

^{*2} When the interleave mode is on, the number of available channels reduces to half (2 channels).
^{*3} True for DL1740 s with the "/C10" option.

For more information on the DL1740 specifications, check out our web site at:

<http://www.yokogawa.com/tm/Bu/DL1700>

Product and Suffix Codes of Model DL1740

Product Code	Suffix Code	Description
701710		DL1740 digital oscilloscope
Power cable	-D	UL and CSA standard
	-F	VDE standard
	-Q	BS standard
	-R	SAA standard
Built-in drive	J1	Floppy drive
	J2	Zip drive
Options	/B5	Built-in printer
	/E2	Two additional passive probes*1
	/P4	Four-outlet probe power supply
	/C7	SCSI and serial interfaces
	/C10	Ethernet interface

*1 The DL1740 main unit comes standard with two 700988 passive probes.

Standard Accessories

Product	Q'ty
Power cord	1
700988 passive probe (400MHz)	2
Power fuse	1
Transparent front cover	1
Printer roll paper (when "/B5" option is included)	1
User's manual (one set)	1

Spare Parts

Product	Product Code	Remarks	Min. Order Q'ty
Printer roll paper	B9850NX	30 m long roll	5
Passive probe	700988	10 MΩ (10:1), 400 MHz bandwidth, 1.5 m long	1
Front cover	B9989FA	For protecting of LCD and front panel.	1

Related Oscilloscope Models



Related Products

Product	Product Code	Bandwidth
FET probe	700939	900 MHz
100:1 probe	700978	100 MHz
Differential probes	700925	DC to 15 MHz
	700924	DC to 100 MHz
Current probe	700937	DC to 50 MHz

External View and Dimensions

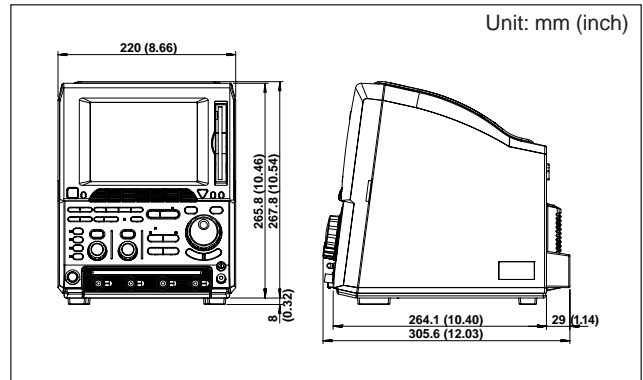

Yokogawa's approach toward preserving the global environment

- Yokogawa Electric's products are developed and manufactured in places of business certified as conforming to the ISO 14001 standard.
- The aforementioned products are designed in due accordance with the *Environment-friendly Product Design Guideline* and the *Environmental Assessment Standard for Product Design* prescribed by Yokogawa Electric Corporation.

- *Signal Explorer* is a registered trademark of Yokogawa Electric Corporation.
- Zip® is either a trademark or a registered trademark of Iomega Corporation in the U.S.A. and other countries.
- The TCP/IP software used in this product and the documentation for that TCP/IP software are based in part on BSD Networking Software, Release 1 licensed from The Regents of the University of California.

NOTICE

- Before operating the product, read the instruction manual thoroughly for proper and safe operation.
- If this product is for use with a system requiring safeguards that directly involve personnel safety, please contact the Yokogawa sales offices.

YOKOGAWA

YOKOGAWA ELECTRIC CORPORATION
 Measurement Sales Dept./Phone: 81-422-52-6614, Fax: 81-422-52-6624
 Network Solutions Sales Dept./Phone: 81-422-52-6765, Fax: 81-422-52-6793

YOKOGAWA CORPORATION OF AMERICA Phone: 1-770-253-7000, Fax: 1-770-251-2088
 YOKOGAWA EUROPE B.V. Phone: 31-33-4622142, Fax: 31-33-4641616
 YOKOGAWA ENGINEERING ASIA PTE. LTD Phone: 65-2419933, Fax: 65-2412606

Subject to change without notice.
 [Ed: 01/b] Copyright ©2000
 Printed in Japan, 012(YG)