

# DL1600 Series

DL1620/DL1640/DL1640L  
Digital Oscilloscopes



*Signal Explorer*

DL1640L

**New Functions**

- Supports USB Memory Devices

Max. Sampling Rate

**200MS/s**

**200MHz**

Bandwidth

**8MW/CH**

Memory

**or 32MW/CH**

**3**-Year Warranty

# The "Mobile" SignalExplorer: from the Lab to the Field



With a three-mode power supply (AC, 12 VDC and battery) the DL1600 goes everywhere you need to make measurements. Serial bus (I<sup>2</sup>C, SPI, CAN) signal capturing and protocol analysis

The DL1640 and DL1640L offer enhanced basic performance characteristics (200 MS/s and 200 MHz bandwidth, and four input channels) in a surprisingly compact and lightweight package (approximately 3.9 kg). The ability to capture records up to 32MW long, simultaneously on four channels, allows you to capture both high-frequency signals and lower-frequency signals over long periods of time. The display consists of a wide-angle 6.4-inch color TFT LCD allowing clear viewing of waveforms in a variety of measuring environments.

## DL1600 Series Lineup

Model	DL1620	DL1640	DL1640L
Feature	701605	701610	701620
Analog input channels	2	4	4
Max. Sampling Rate	200MS/s		
Bandwidth	200MHz		
Max. Record length	8MW/ch	8MW/ch	32MW/ch



The DL1640/1640L can be powered in three ways (AC, 12V DC and battery), giving you the flexibility to make measurements just about anywhere. Power the unit directly from an in-vehicle battery using 12 VDC, or attach the battery and power the unit in the field (runs approximately two hours on a full charge\*), or use the AC input at your test bench in the lab. This DL adapts to the situation!  
\* Operating time depends on usage conditions.

DC-powered model + battery box  
The DC-power option is available on the DL1640 and DL1640L. The main unit must be connected to ground.



Analysis results of 6.4 seconds of I<sup>2</sup>C data.

Trigger condition setup with address: 1F and first byte data: 00

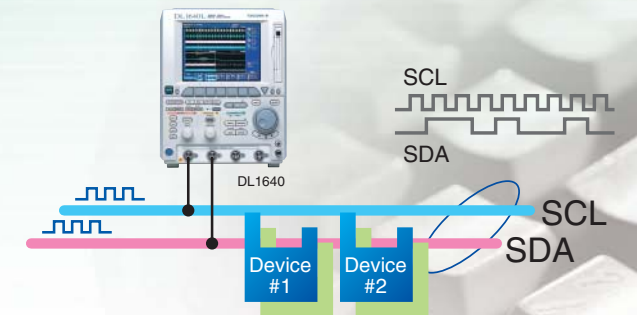

## I<sup>2</sup>C Bus Trigger and Analysis

I<sup>2</sup>C bus signals (SCL and SDA), used extensively in home electronics such as analog and digital televisions, and video cameras, and in communications equipment such as mobile phones can be captured with specialized triggers and displayed as waveforms. Triggers can be based on start conditions, non-ack (when acknowledgement is not received) and user specified address and data patterns. Use up to 32 megawords of memory (DL1640L) to acquire long strings of I<sup>2</sup>C bus waveform data and then analyze the data in a time-series manner. SPI Bus (a synchronous 8-bit serial bus) waveforms can also be analyzed and the data displayed.

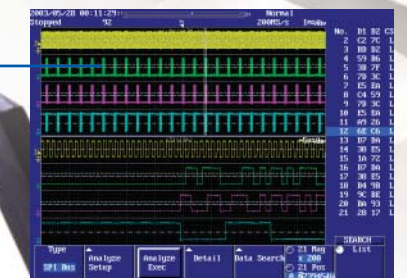

SPI analysis results display

## CAN Bus Trigger and Analysis

Using dedicated triggers, CAN bus signals can be captured and displayed as waveforms. (The CAN bus option supports both high-speed and low-speed CAN. CAN is used widely in the internal communication buses of automobiles, FA machinery, medical equipment, and other devices.) Analysis performed according to the CAN protocol can be displayed in a list together with the waveforms. Use up to 32 megawords of memory (DL1640L) to acquire long strings of CAN bus waveform data and then analyze the data in a time-series manner. Analysis results are then listed along with the waveform. Results include: ID and Data fields, ACK field status and other information. The CAN bus search function quickly searches the acquired data for user-defined ID and data patterns, RTR or ACK bits. Searches for indefinite bit states can also be performed.

No.	Time (ms)	ID	Data	CR	ACK	Info.
0	-7.189	111	68 82PC	Y		
1	-5.549	498	33 132A	Y		
2	-3.043	215	52 799F	Y		
3	-3.563	166	40 14F1	Y		
4	-3.121	166	40 14F1	Y		
5	1.578	166	40 14F1	Y		
6	6.872	166	50 2A28	Y		
7	8.188	166	40 14F1	Y		
8	1.626	166	87 800F	Y		
9	2.874	123	22 3296	Y		
10	3.556	234	67			
11	4.812	175	41			
12	6.852	111	68 82PC	Y		
13	5.582	166	55 2317	Y		
14	6.852	111	68 82PC	Y		
15	7.528	498	83 132A	Y		

Detailed Analysis Results



Waveform Display and Analysis Results

## Simple and enhanced triggers

- Edge** Triggers on a rising or falling edge.
- A → B(N)** Triggers on the n-th occurrence of condition B after condition A has gone true.
- A Delay B** Triggers if condition B goes true after condition A has gone true and an interval at least equal to the delay setting has elapsed.
- Pattern** Triggers when the state conditions (H or L) on multiple channels goes true and a channel edge condition is met. A clock setting can also be made.
- Width** Triggers based on the pulse width. The trigger may be selected from the following options: Pulse < T<sub>1</sub>, Pulse > T<sub>1</sub>, T<sub>1</sub> < PLS < T<sub>2</sub>, T<sub>1</sub> > PLS > T<sub>2</sub>, Time-out. The width trigger may be combined with a window trigger, in which two trigger level values can be set. This makes it possible to set a virtual pulse as a trigger condition.
- OR** Triggers when any trigger condition on multiple channels goes true. The OR trigger may also be combined with a window trigger.
- TV** NTSC, PAL, SECAM, HDTV (8 types)
- I<sup>2</sup>C** Start, Non-Ack, Address & Data, Combination (optional)
- CAN** ID, Data Field, Error Frame, Combination, etc (optional)

### Action-on trigger

With the action-on trigger, a specified action is automatically executed each time the trigger is activated. You can use the trigger for a variety of actions, such as automatically saving captured data. The action-on trigger is useful for purposes such as collecting data in continuous tests.

## Small Footprint

The DL1600 takes up less bench space than an A4 piece of paper, making it ideal for testing in areas with limited space. The DL1600 is also lightweight; weighing only 3.9 kg (without options). From the lab to the field, the DL1600 works wherever you do; and takes up "very little space."

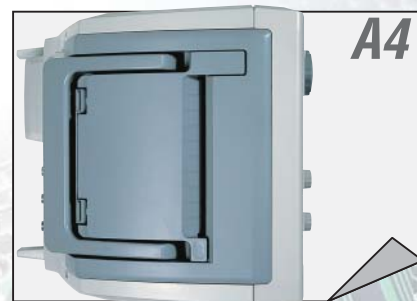

New

## Quick and simple saving of waveforms

USB flash memory (USB rev 1.1 compliant) can be used for saving a variety of data files, including waveform data\*. When you select the PC card interface as the removable media type, you can use ATA flash memory cards, compact flash, high capacity microdrives, and other media. Additionally, 2 MB of flash memory is built into the main unit. The flash memory is convenient if other storage media is not handy.

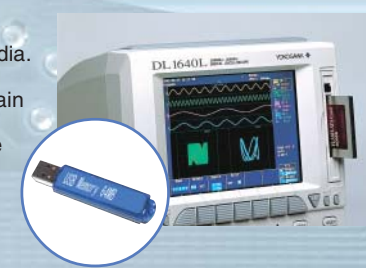

\* Available only when the following is displayed on the Overview screen. "USB Mass Storage"

## Immediately print out screen images

Simply press the COPY key and immediately print the current screen image using the built-in printer, a USB printer or a network printer. The built-in printer is ideal for printing that "just gotta have" image - in the lab, or in the field.



# Accurately, Easily, and Instantly Explore the Signals You Are Looking For

Signal Explorer

Max. 32MW Memory (All points display)

Up to 32 MW of data (with the DL1640L) can be acquired even when all four channels are used. This long memory allows you to maintain fast sampling speeds even while capturing long-duration events.

In the picture at the right, three signals from a switching power supply have been captured (switching element voltage, current, and primary-side surge current) from the time the power is turned on, until the switching starts and stabilization is reached. The DL1600's super long memory lets you maintain high sampling rates for capturing individual pulses, and still record for a long period of time.



32 MW long memory and Dual Zoom

## Real-Time Digital Filtering for Finding Signals Hidden in Noise

One important role for oscilloscopes is measuring the noise on a waveform. Sometimes, however, this noise prevents you from observing the targeted signals. Real-time digital filtering lets you easily apply a low pass filter while capturing data, so that waveforms hidden in noise can be clearly displayed.

Filters can be set separately on each channel. In combination with an analog filter, cutoff frequencies ranging from 20 MHz to 10 kHz can be set. In addition, when the real-time digital filtering is used in high-resolution mode, data resolution increases to as much as 13 bits, and signals can be reproduced even more accurately on the screen.



Data Stream Engine II with internal digital filters

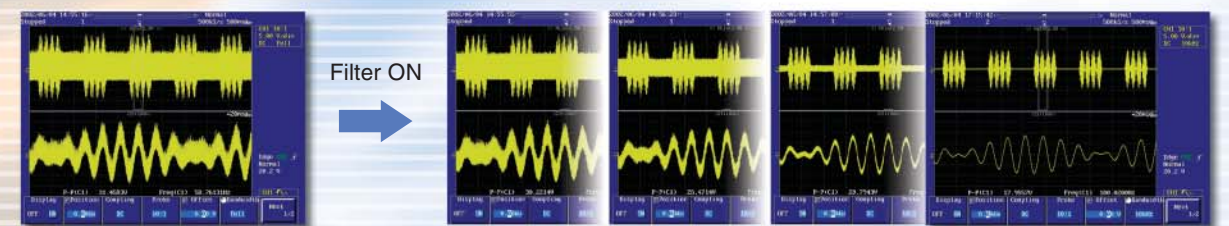

## Smart Search Functions Help Find the Data You Need

"I want to find a specific serial data pattern", "I need to search for surge pulses of less than 30 ns", "I want to only extract waveforms that occasionally overshoot by an excessive amount".....As data volume increases, it becomes more important to be able to search for target phenomena efficiently. The Smart Search function automatically detects serial patterns, pulse widths, rising edges, falling edges, and other phenomena in the captured waveform data. These phenomena are then displayed in the zoom screen. Smart Search will significantly improve the efficiency of your development and evaluation work.

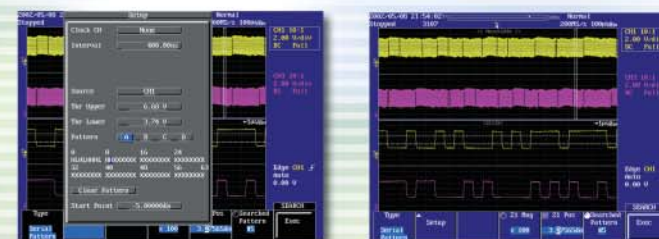

Serial pattern search setup

Serial pattern search results

### Pulse Width Search Example

Searches the active waveform for pulses that meet the user-defined width conditions.

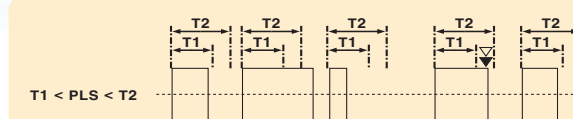

## Web server function

Using the Ethernet interface(optional), you can easily connect to a network or a PC. Using the Internet Explorer web browser on your PC, you can view the DL1600's screen, save scope data to the PC, or load setup files from the PC to the scope.

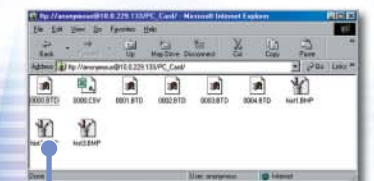

### FTP

Easily copy and paste files to and from a PC from the internal flash memory drive and other internal storage media. You don't have to use a separate program to transfer the data.



### Data Capture

Download screen images periodically or manually. Download waveform data. Start or Stop a measurement, or setup a split display by using this menu.

## All-Points Display and Fast Screen Updates Capture Hidden Abnormalities

All-points display shows every single data point that is captured in memory. All-points display shows phenomena that may be missed in a compressed waveform display. With Yokogawa's proprietary Data Stream Engine II, screen update rates don't slow down, even when zooming the waveform, or performing automatic waveform measurements. With fast screen update rates, changes made to instrument settings happen instantaneously and instrument control is responsive.

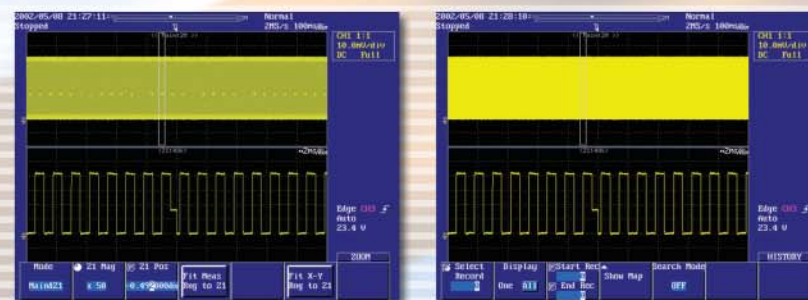

All-points display example

Conventional compressed display

## History Memory & History Search

### Tools for Efficient Troubleshooting

Easily and reliably capturing abnormal waveforms that occur infrequently is an important aspect of troubleshooting. It is impossible to predict the moment and timing at which an abnormal waveform might appear. The history memory is effective in these cases. After stopping the acquisition, the DL1600 series can use its History Memory to view, search and analyze up to 16,000 previously acquired waveforms.

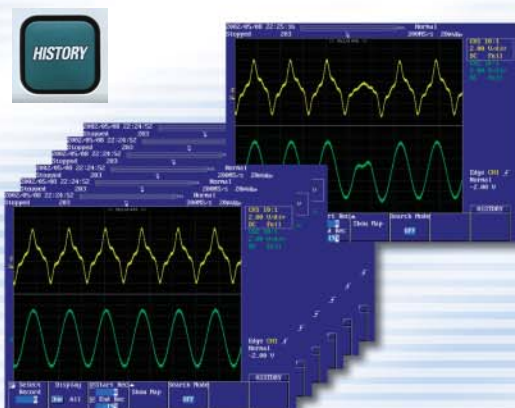

### History Search

You can extract acquisitions that meet specific criteria from this large volume of historical data. Search methods include judging whether a signal passes through or does not pass through a specified "box" (screen area), and judging computed results of waveform parameters such as minimum and maximum values.



Rear panel ports connect to a wide range of peripherals

Probe power ports (optional)

These ports power current probes (701930, 701931, 700932, 700933) and differential probes (701920, 701921, 701922, 700924, 700925).

USB port for PC control (optional)

This port lets you control the SignalExplorer using a PC.

USB ports for peripheral devices connection (optional)

Type A connectors: 2 ports compatible with USB Flash memory\*, HD drive\*, USB printers, keyboard and mouse.

\*: Available only when the following is displayed on the Overview screen. "USB Mass Storage"

GO/NO-GO judgment I/O port

Input waveform determination timing signals and output results as TTL level signals using the GO/NO-GO judgment function.

GO/NO-GO Judgment Function

This function determines waveform data in a measured waveform based on specified zones or waveform parameters and automatically performs a specified action. Available actions include printing screen images, saving waveform data, sounding an internal buzzer, and sending an email.

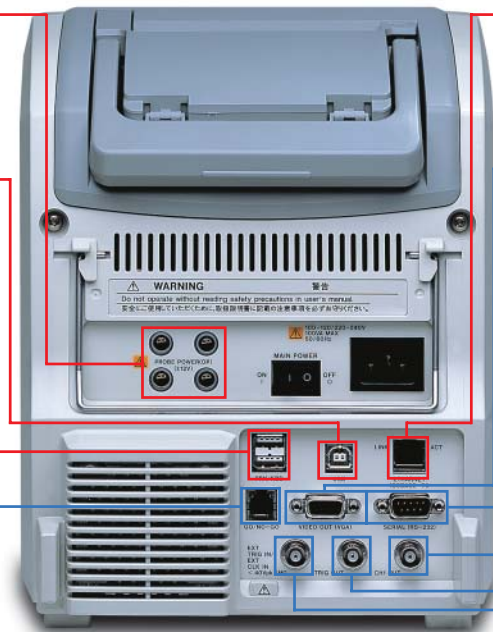
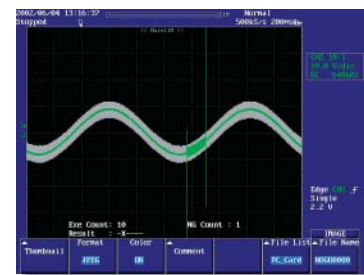

Ethernet port (optional)

Supports 100BASE-TX and 10BASE-T. Selective optional port from GP-IB or Ethernet (The Ethernet or the GPIB option can be chosen for this location.)

VGA video port

This port outputs video signals so that waveforms can be viewed on an external monitor.

Serial port (RS-232)

CH1 output

This port normalizes and outputs the CH1 input signal. It can be used to connect a measurement instrument such as a counter.

Trigger output

This port outputs a TTL level trigger signal.

External trigger input/external clock input

This port can be used to input a trigger signal which is separate from the input signal. In addition, it can be used as an input port for an external sampling clock signal (40 Hz to 5 MHz).

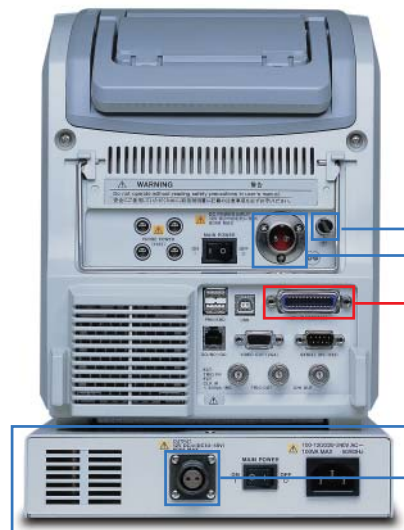

Rear Panel Ports for DC Power Models

Grounding terminal

Metal Plug for connecting to the Battery Box

GP-IB port (optional)

The GP-IB and Ethernet options cannot be combined - select one or the other. GP-IB is available on DC and non-DC models.

701680 Battery Box

Metal Plug Connector provides DC power to the main unit

Software

Xviewer (701992)

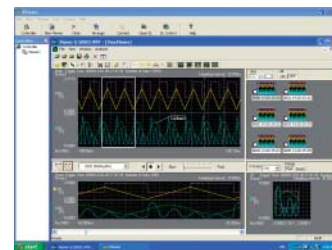

Xviewer is a PC software application designed to work with Yokogawa's DL series digital oscilloscopes and the DL750 series ScopeCorders. Xviewer allows you to display DL-acquired waveform data (using the "Viewer" function), perform file transfers, and control DL series instruments remotely.

You can download a trial version of Xviewer from YOKOGAWA's web site at: <http://www.yokogawa.com/tm/701992/>

MATLAB tool kit (701991)

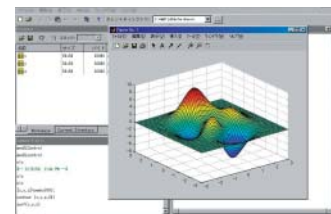

The MATLAB tool kit for the DL series is a plug-in for MATALAB software. The toolkit can be used to control supported DL series instruments using MATLAB or to acquire data from a DL series instrument for use in MATALAB via a communication interface (GP-IB, USB, Ethernet).

You can download a trial version of MATLAB tool kit from YOKOGAWA's web site at: <http://www.yokogawa.com/tm/701991/>

Basic Specifications

Input Channels	4 (701610, 701620) 2 (701605)
Input Coupling	1 MΩ AC, 1 MΩ DC, GND
Input Impedance	1 MΩ ±1.0%, 28 pF at 1 MHz
Sensitivity	2 mV/div to 10 V/div (in steps of 1, 2, or 5)
Maximum Input Voltage	300 V DC or 300 Vrms CAT I, 424 Vpeak
DC Accuracy <sup>1</sup>	2 mV/div to 5 mV/div: ±2.0% of 8 div + offset voltage accuracy 10 mV/div to 10 V/div: ±1.5% of 8 div + offset voltage accuracy
Offset Voltage Accuracy <sup>1</sup>	2 mV/div to 50 mV/div: ±(1% of setting + 0.2 mV) 100 mV/div to 500 mV/div: ±(1% of setting + 2 mV) 1 V/div to 10 V/div: ±(1% of setting + 20 mV)
Frequency Characteristics <sup>1</sup>	10 mV/div to 10 V/div: DC to 200 MHz 2 mV/div to 5 mV/div: DC to 80 MHz (using 700960; specified at probe tip)
Vertical Resolution	8 bits (24 LSB/div)
Maximum Sampling Rate	High resolution mode: Maximum 13 bits During real-time sampling: 200 MS/s During equivalent time sampling: 50 GS/s
Maximum Record Length	701605, 701610: 8 MW/ch (in single trigger mode) 1 MW/ch (in other modes) 701620: 32 MW/ch (in single trigger mode) 4 MW/ch (in other modes)
Sweep Time	2 ns/div to 800 s/div (varies depends on memory length)
Time Base Accuracy <sup>1</sup>	±0.005%
External Clock Input	Input frequency range: 40 Hz to 5 MHz (continuous clock only)

Trigger

Trigger Modes	Auto, Auto Level, Normal, Single, Single (N)
Trigger Sources	CH1 to CH4 (CH2: model 701605), LINE (-AC model only), EXT
Trigger Types	Edge, A → B(N), A delay B, OR, pattern, pulse width, TV (NTSC, PAL, SECAM, 1080/60p, 1080/60i, 1080/24p, 1080/50i, 1080/25p, 1080/24sF, 720/60p, 480/60p), I <sup>2</sup> C (optional), CAN (optional)

Display

Display	6.4-inch TFT color liquid crystal display <sup>2</sup>
Screen Updating Rate	Up to 60 times per second during 100 kW all-points display Up to 30 times per second during 1 MW all-points display <sup>2</sup> The LCD may contain some pixels that are always off or always on. In addition, brightness may vary due to the characteristics of the LCD, but this is not an indication of any problem with the display.

Functions

Waveform Acquisition/Display Functions

Acquisition Modes	Normal, Averaging, Envelope
Record Length	701605, 701610: 1 kW, 10 kW, 100 kW, 1 MW, 8 MW (4 MW) 701620: 1 kW, 10 kW, 100 kW, 1 MW, 4 MW, 10 MW, 32 MW (16 MW)
Zooming	( ): High Resolution Mode Up to two locations can be set with separate enlargement ratios. (Display: Main, Z1 only, Z2 only, Main & Z1, Main & Z2, Main & Z1 & Z2)
History Memory	701605, 701610: Automatically saves acquisition data of up to 4,000 records. 701620: Automatically saves acquisition data of up to 16,000 records.
Display Format	The display can be split to one, two, or four windows (701610, 701620). The display can be split to one or two windows (701605).
X-Y Display	Two X-Y waveform displays (XY1 and XY2 <sup>4</sup> ) can be displayed in separate windows. <sup>4</sup> XY2 is available for only model 701610 and 701620. Permits waveform overlaying (Persistence, Color)
Accumulate	

Analysis Functions

Search and Zoom	Edge, Serial Pattern, Parallel Pattern, Pulse Width, Auto Scroll
History Search	Zones, Parameters
Cursor Types	Marker, Horizontal, Vertical, Degree, Vertical History, H&V, CAN (optional)
Automatic Waveform Parameter Measurements	Peak-to-peak, Max, Min, Avg, Rms, Sdev, High, Low, +Oshot, -Oshot, Int1TY, Int2TY, Int1XY, Int2XY, Freq, Period, Rise, Fall, +Width, -Width, Duty, Burst1, Burst2, Pulse, AvgFreq, AvgPeriod, Delay (between channels)
Waveform Parameters for Statistics	Parameters: Listed above Statistics: Min, Max, Avg, Cnt, Sdv Statistical modes: Normal Statistics, Cycle Statistics, History Statistics
Math Function	Addition, Subtraction, Multiplication, Power Spectrum
GO/NO-GO Judgment	GO/NO-GO judgment based on waveform parameter measurement values or waveform zones

I<sup>2</sup>C Bus Analysis Option Specifications

Applicable Buses	I <sup>2</sup> C Bus
I <sup>2</sup> C Bus	Maximum 3.4 Mbps
Bus Transfer Rate	7 bit
Address Mode	Complies with System Management bus
SM Bus	
Trigger	
Trigger Source	CH1: SCL CH2: SDA CH3, CH4: Analog Signals

Start Trigger	Trigger activated by the Start Condition
Non-ACK Trigger	Trigger when No Acknowledgement bit is returned
Address Trigger	Compared with designated address
Data Trigger	Compared with designated data
Combination Trigger	Address and Data trigger types I <sup>2</sup> C bus conditions with CH3/CH4 analog signals

Analysis Functions

Waveform and Data Display	Simultaneous data display (in hex notation) and waveform
Detailed Data Display	Data transfer time starting at trigger point data and acknowledgement exist/not exist
Maximum Analyzed Data Size	40,000 bytes
Analyzed Channels	SCL: CH1, CH3. SDA: CH2, CH4 The two pairs of SCL and SDA can be analyzed alternately

CAN Bus Analysis Option Specifications

Supported CAN Bus Specifications

CAN Bus	CAN Version 2.0B
Bit rate:	33.3 kbps, 50 kbps, 83.3 kbps, 95.2 kbps, 100 kbps, 125 kbps, 250 kbps, 500 kbps, 1 Mbps Hi-Speed CAN (ISO11898) Low-Speed CAN (ISO11519-2)

Trigger

Trigger source	CH1: Input from the differential probe SOF trigger
Trigger type	ID Field trigger Selectable from 4 types of IDs RTR trigger Data Field trigger Configurable up to 8 bytes Error Frame trigger Combination trigger (based on a combination of these five types of triggers)

Analysis Functions

Number of analyzable frames	16000 maximum
Analysis results display	Listing and waveform display of analysis results Detailed analysis list display
Auxiliary analysis functions	Data Search function Field Jump function Stuff bit calculation function CAN cursor function

SPI Bus Analysis Functions

Analyzable data	40000 bytes maximum
Analysis results display	Listing and waveform display Detailed analysis list display
Auxiliary analysis functions	Data Search function

Rear Panel I/O Ports

Communication Interfaces	Serial port (RS232), USB port (optional), USB-PC port (optional), GP-IB port (optional <sup>3</sup> ), Ethernet port (complies with 100BASE-TX and 10BASE-T; optional <sup>3</sup> ) <sup>3</sup> Choose one from the Ethernet port and GP-IB port options.
Signal I/O	External Trigger Input/External Clock Input, Trigger Output, VGA video signal output, GO/NO-GO judgment I/O, CH1-OUT
Probe Power Port (optional)	Output ports: 4 (701610, 701620) 2 (701605) Output voltage: ±12 V

Battery Box (Used with DC Power Model Only)

Operating Time	Approx. 2 hours (varies depending on usage conditions)
Charging Time	Approx. 4.5 hours
Number of Charges (cycle life)	Approx. 500 (varies depending on usage environment)
Rated Output Voltage	12 V (14 V: AC power supply)
Rated Supply Voltage	100 to 120 VAC/220 to 240 VAC (automatically switches)
Rated Supply Frequency	50/60 Hz
Maximum Power Consumption	200 VA
Operating Temperature Range	5°C to 40°C (Operating conditions) 5°C to 35°C (Charging conditions)
Weight	Approx. 2.9 kg (6.4 lbs)
Exterior Dimensions	220 × 50 × 248 mm (WHD) 8.66 × 1.97 × 9.76 inch (WHD)

General Specifications

Exterior Dimensions	220 × 266 × 224 mm (WHD) 8.66 × 10.47 × 8.82 inch (WHD) (with printer cover closed; does not include protrusions)
Weight	Approx. 4.5 kg (10.8 lbs; with all options) Approx. 3.9 kg (8.6 lbs; without any options)
Operating Temperature Range	5°C to 40°C
AC Power Model	
Rated Supply Voltage	100 to 120 VAC/220 to 240 VAC (automatically switches)
Rated Supply Frequency	50/60 Hz
Maximum Power Consumption	100 VA
DC Power Model	
Rated Supply Voltage	DC 12 V (Rated 10-18 V)
Maximum Power Consumption	60 VA

1: Measurements taken based on internal clock after calibration, following warmup period under reference operating conditions (see below).  
Operating Conditions Ambient temperature: 23 ± 5°C  
Ambient humidity: 55 ± 10% RH

**DL1620/DL1640/DL1640L**  
**Model Numbers and Suffix Codes**

Model/Options	Suffix code	Description
701605		DL1620 digital oscilloscope
701610		DL1640 digital oscilloscope
701620		DL1640L digital oscilloscope
	-AC	100–120 V & 220–240 V
	-DC <sup>1</sup>	12 VDC
Power cable	-D	UL/CSA standard
	-F	VDE standard
	-Q	BS standard
	-R	AS standard
	-H	GB standard
	-Y	No power cable
Internal media drive	-J1	Floppy drive <sup>2</sup>
	-J2	Zip <sup>®</sup> drive <sup>2</sup>
	-J3	PC card drive (Type II) <sup>2</sup>
Other options	/B5	Built-in printer
	/P2	Probe power for 701605
	/P4	Probe power for 701610 and 701620
	/C1	GP-IB + USB <sup>3</sup>
	/C10	Ethernet + USB <sup>3</sup>
	/F5	I <sup>2</sup> C bus analysis function <sup>4</sup>
	/F7	CAN bus analysis function <sup>5</sup>

The main unit comes standard with four passive probes (700960) for 701610/701620 and two passive probes for 701605.

- Select "-Y" for the DC power model. Available only for model 701610 and 701620.
- Choose one.
- Choose one.
- The I<sup>2</sup>C bus analysis function (/F5) includes the SPI analysis function. This option only be specified for model 701610 and 701620.
- The CAN bus analysis function (/F7) includes the SPI analysis function. This option only be specified for model 701610 and 701620.

Model/Options	Suffix code	Description
701680 <sup>6</sup>		Battery box and charger
Power cable	-D	UL/CSA standard
	-F	VDE standard
	-Q	BS standard
	-R	AS standard
	-H	GB standard

<sup>6</sup> The Battery box comes standard with the cable for connecting to the main unit.

**Accessories**

<p><b>50 MHz current probe (701933)</b> Input range: 30 Arms</p>	<p><b>10 MHz current probe (701930)</b> Input range: 150 Arms</p>	<p><b>100 MHz 100:1 probe (700978)</b> Maximum input voltage: ±4000 V</p>	<p><b>100 MHz differential probe (700924)</b> Attenuation ratio: Either 1/100 or 1/1000 Maximum differential allowed voltage: ±1400 V</p>	<p><b>200 MHz differential probe (701922)</b> Attenuation ratio: 1/10 with 50 Ω load Max. differential allowed voltage: ±20 V</p>	<p><b>100 MHz differential probe (701921)</b> Attenuation ratio: Either 1/10 or 1/100 Maximum differential allowed voltage: ±70 V (1/10), ±700 V (1/100)</p>
--	---	---	---	---	--

For detailed specifications, visit our web site at

<http://www.yokogawa.com/tm/DL1600>

[Signal Explorer is a registered trademark of Yokogawa Electric Corporation.]

Microsoft, MS, Windows, and Internet Explorer are trademarks or registered trademarks of Microsoft Corporation in the US and other countries.  
 Microdrive is a trademark or registered trademark of International Business Machines Corporation in the US and other countries.  
 Zip is a trademark or registered trademark of Iomega Corporation in the US and other countries.  
 Other company names and product names appearing in this document are trademarks or registered trademarks of their respective companies.



**YOKOGAWA ELECTRIC CORPORATION**  
 Communication & Measurement Business Headquarters /Phone: (81)-422-52-6768, Fax: (81)-422-52-6624  
 E-mail: tm@csv.yokogawa.co.jp

**YOKOGAWA CORPORATION OF AMERICA** Phone: (1)-301-916-0409, Fax: (1)-301-916-1498  
**YOKOGAWA EUROPE B.V.** Phone: (31)-33-4641858, Fax: (31)-33-4641859  
**YOKOGAWA ENGINEERING ASIA PTE. LTD.** Phone: (65)-62419933, Fax: (65)-62412606

Subject to change without notice.  
 [Ed : 03/b] Copyright ©2002  
 Printed in Japan, 507(KP)

**Standard Accessories**

Accessory	Quantity
Power cable <sup>7</sup>	1
Passive probe (700960)	Number of channels
Transparent front cover	1
Soft case for probes	1
Printer roll paper (when option /B5 is selected)	1
User's manual (one set)	1

<sup>7</sup> The power cable is included in the AC power model only.

**Supplies**

Product	Part number	Description	Order quantity
Printer roll paper	B9850NX	30-meter roll (one roll per package)	5
Passive probe	700960	10 MΩ (10:1), 200 MHz band, 1.5 meters, 1 probe per package	1
Front cover	B9989FA	For protecting LCD and front panel	1

**Optional Accessories**

Product	Model number	Description
100:1 probe	700978	100 MHz
Current probe	700933	DC to 50 MHz, 30 Arms
Current probe	701930	DC to 10 MHz, 150 Arms
Current probe	701931	DC to 2 MHz, 500 Arms
Current probe	701932	DC to 100 MHz, 30 Arms
Differential probe	700924	DC to 100 MHz
Differential probe	700925	DC to 15 MHz
Differential probe	701921	DC to 100 MHz
Differential probe	701922	DC to 200 MHz <sup>8</sup>
50 Ω terminator	700976	Pass-through type

<sup>8</sup> The 50 Ω terminator (700976) is necessary for connecting to the main unit.

**Exterior Dimensions**

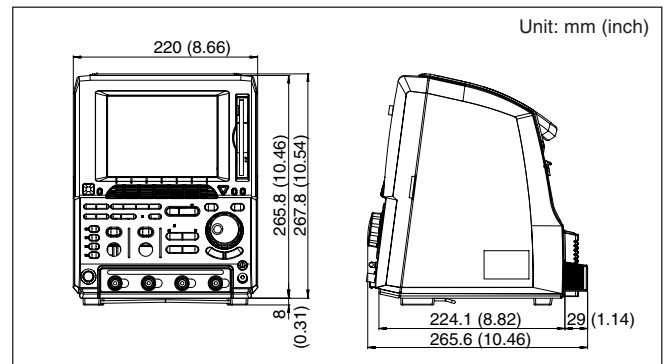

**Yokogawa's Approach to Preserving the Global Environment**

- Yokogawa's electrical products are developed and produced in facilities that have received ISO14001 approval.
- In order to protect the global environment, Yokogawa's electrical products are designed in accordance with Yokogawa's Environmentally Friendly Product Design Guidelines and Product Design Assessment Criteria.

**NOTICE**

- Before operating the product, read the user's manual thoroughly for proper and safe operation.
- If this product is for use with a system requiring safeguards that directly involve personnel safety, please contact the Yokogawa sales offices.