

This literature was published years prior to the establishment of Agilent Technologies as a company independent from Hewlett-Packard and describes products or services now available through Agilent. It may also refer to products/services no longer supported by Agilent. We regret any inconvenience caused by obsolete information. For the latest information on Agilent's test and measurement products go to:

[www.agilent.com/find/products](http://www.agilent.com/find/products)

Or in the US, call Agilent Technologies at 1-800-452-4844 (8am–8pm EST)



# HP 8752C and HP 8753D Network Analyzers

## Technical Specifications

**300 kHz to 1.3, 3, or 6 GHz**  
**30 kHz to 3 GHz or 6 GHz**

Two excellent choices, the HP 8752C and HP 8753D continue the tradition of affordable excellence in RF component measurements for the lab and production test areas.

The HP 8752C and HP 8753D network analyzers bring superior performance and useful productivity features to simplify and speed your device, component, or network measurements in the 30 kHz to 6 GHz frequency range.

A swept synthesized source, sensitive receiver, and crisp color display ensure rapid, accurate, and easy-to-read test results.

Since the HP 8752C and HP 8753D are vector network analyzers, they not only provide magnitude and phase information, but also offer up to 110 dB dynamic range, make group delay and time domain measurements, and utilize vector accuracy enhancement to minimize measurement uncertainty.

### HP 8752C optimizes economy and convenience

The HP 8752C provides much of the performance of the HP 8753D at a substantial cost reduction. Among the most important features of the HP 8752C are:

- Frequency range from 300 kHz to 1.3 GHz, or optionally 3 GHz or 6 GHz.
- 50 and 75 ohm solutions.
- Built-in test set for transmission and reflection measurements.
- Optional step attenuator for extended source output power range.

### HP 8753D maximizes versatility and performance

The HP 8753D offers even more flexibility and measurement capability than the HP 8752C in the following areas:

- Frequency range from 30 kHz to 3 GHz, or optionally 6 GHz.
- Built-in S-parameter test set provides complete forward and reverse measurements, allowing you to completely characterize your component with a single connection.
- 50 and 75 ohm solutions.
- Superb accuracy. The most comprehensive calibration available guarantees accurate measurements. TRL\*/LRM\* makes calibration in non-coaxial environments easier and more convenient.
- Mixer testing. Quickly and easily characterize frequency translating devices such as mixers.
- Add swept harmonic measurements. Characterize amplifier parameters – gain, 1 dB compression, match – and 2nd and 3rd harmonic distortion with the same test setup.
- Built-in 3.5 inch floppy disk drive provides convenient storage of instrument states and data.
- Parallel and serial ports provide interfaces to popular printers and plotters. The parallel port can also be used as a general I/O bus, with user-controllable TTL inputs and outputs. Users can also connect a DIN keyboard to speed up entry of titles, labels, or file names, and for remote front panel operation.

---

## Definitions and Test Conditions

This document provides two types of performance information:

*Specifications* describe the instrument's warranted performance over the temperature range of  $23 \pm 3^\circ\text{C}$ , unless otherwise stated. Specifications for frequencies above 3 GHz do not apply to instruments with Option 075 (75 ohm impedance).

*Supplemental characteristics* are typical but non-warranted performance parameters. These are denoted as "typical," "nominal," or "approximate."

### Dynamic Range

*System dynamic range* is the noise level relative to a "thru." It is calculated as the difference between the maximum receiver input level and the receiver's noise floor. System dynamic range applies to transmission measurements only, since reflection measurements are limited by directivity.

Noise floor is specified as the mean of the noise trace over frequency. A signal at this level would have a signal/noise power ratio of 3 dB. Noise floor is measured with the test ports terminated in loads, full two-port error correction (with 16 averages used during isolation), 10 Hz IF bandwidth (BW), maximum test port power, and no averaging during the measurement.

### Measurement Uncertainty

Curves show the worst-case magnitude and phase uncertainty for reflection and transmission measurements, after a full two-port calibration (including isolation with an averaging factor of 16) using the specified cal kit, with 10 Hz IF bandwidth (BW) and no averaging.

*Calibration* is the process of measuring known standards from a calibration kit to characterize a network analyzer's systematic (repeatable) errors.

*Reflection measurement uncertainty* is plotted as a function of S11 (reflection coefficient, linear). The curves assume a one-port device ( $S_{21}=S_{12}=0$ ).

*Transmission measurement uncertainty* is plotted as a function of S21 (transmission gain/loss) in dB from the reference level. The curves assume that the device is well-matched ( $S_{11}=S_{22}=0$ ).

The reference level for HP 8753D measurements is -2 dBm test port power. For HP 8752C measurements, the reference level is -10 dBm test port power.

## Measurement Port Characteristics

*Corrected (residual)* indicates performance after error correction (calibration). It is determined by the quality of calibration standards and how well "known" they are, plus system repeatability, stability, and noise.

*Uncorrected (raw)* indicates intrinsic performance without error correction. This is related to the ultimate stability of a calibration.

## Organization of Data

The information in this document is organized into the following sections. All data is subject to change.

### System Performance Summary

These pages describe specifications or characteristics that apply to complete HP 8753D and HP 8752C measurement systems in various connector types. The measurement uncertainty curves and measurement port characteristics given for HP 8753D systems also apply to the HP 8753D with Options 006 and 011 and the HP 85047A test set (50 ohm), or the HP 8753D Option 011 with an HP 85046B test set (75 ohm).

### Test Port Output Characteristics

#### Test Port Input Characteristics

Separate sections are provided for an HP 8753D (no Option 011), HP 8753D with Option 011, and HP 8752C.

### Supplemental Characteristics

These apply to both the HP 8752C and the HP 8753D unless otherwise noted.

### HP 8753D Test Set Specifications

This section provides information on test sets that are available for use with the HP 8753D Option 011.

### HP 8753D Accessories

#### HP 8752C Accessories

These sections contain information about calibration kits, cables, adapters, and other accessories. Many of the HP 8753D accessories can also be used with the HP 8752C. In these cases, specifications for those accessories may be found in the HP 8753D section.

# System Performance Summary

## HP 8753D (50 ohm systems) 7 mm Test Ports

The following specifications describe the system performance of the HP 8753D network analyzer with an integrated 50 ohm s-parameter test set configuration. System hardware includes the following:

- Network analyzer: HP 8753D Option 006
- Calibration kit: HP 85031B
- Test port cables: HP 11857D

### Dynamic Range

These specifications apply to transmission measurements in the 30 kHz to 6 GHz frequency range at 10 Hz IF BW with full two-port error correction. Dynamic range is limited by maximum receiver input level and the receiver's noise floor.

### System dynamic range:

- 30 kHz to 300 kHz ..... 100 dB<sup>1</sup>
- 300 kHz to 1.3 GHz ..... 110 dB<sup>2</sup>
- 1.3 GHz to 3 GHz ..... 110 dB
- 3 GHz to 6 GHz ..... 105 dB

### Specified Measurement Uncertainty<sup>3</sup>

The following graphs show the specified measurement uncertainty for the HP 8753D over the full frequency range using full two-port error correction.

### Transmission Measurements<sup>4</sup>

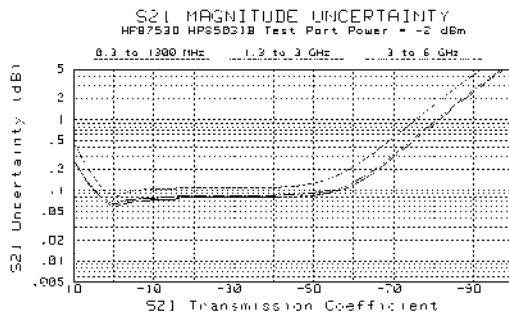

### Magnitude

### Measurement Port Characteristics

The following specifications show the residual HP 8753D system uncertainties for uncorrected performance and after accuracy enhancement using full two-port error correction. These characteristics apply for an environmental temperature of 25 ± 5°C, with less than 1°C deviation from the calibration temperature.

Corrected	Frequency Range			
	30 kHz-300 kHz <sup>6</sup>	300 kHz-1.3 GHz	1.3 GHz-3 GHz	3 GHz-6 GHz
Directivity	55 dB	55 dB	51 dB	46 dB
Source Match	55 dB	51 dB	49 dB	43 dB
Load Match	55 dB	55 dB	51 dB	46 dB
Refl. tracking	±0.001 dB	±0.001 dB	±0.005 dB	±0.020 dB
Trans. tracking	±0.008 dB	±0.006 dB	±0.009 dB	±0.021 dB
Uncorrected <sup>6</sup>				
Directivity	20 dB*	35 dB	30 dB	25 dB
Source Match	18 dB**	16 dB	16 dB	14 dB
Load Match	20 dB**	18 dB	16 dB	14 dB
Refl. tracking	± 2.0 dB	± 1.5 dB	± 1.5 dB	± 2.5 dB
Trans. tracking	± 2.0 dB	± 1.5 dB	± 1.5 dB	± 2.5 dB
Crosstalk	100 dB	100 dB	100 dB	90 dB

\*15 dB, 30 kHz to 50 kHz

\*\*10 dB, 30 kHz to 50 kHz

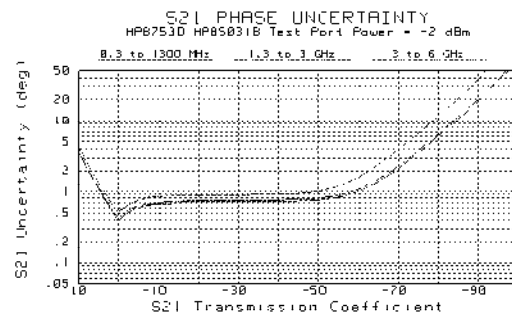

### Phase

### Reflection Measurements<sup>5</sup>

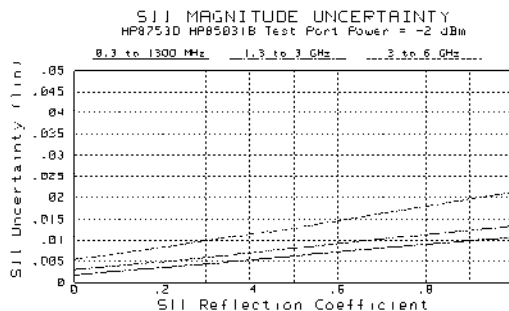

### Magnitude

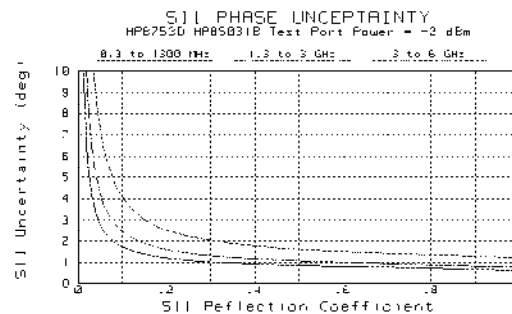

### Phase

# System Performance Summary

## HP 8753D (50 ohm systems) Type-N Test Ports

The following specifications describe the system performance of the HP 8753D network analyzer with an integrated 50 ohm s-parameter test set configuration. System hardware includes the following:

- Network analyzer: HP 8753D Option 006
- Calibration kit: HP 85032B
- Test port cables: HP 11851B

### Dynamic Range

These specifications apply to transmission measurements in the 30 kHz to 6 GHz frequency range at 10 Hz IF BW with full two-port error correction. Dynamic range is limited by maximum receiver input level and the receiver's noise floor.

### System dynamic range

- 30 kHz to 300 kHz ..... 100 dB<sup>1</sup>
- 300 kHz to 1.3 GHz ..... 110 dB<sup>2</sup>
- 1.3 GHz to 3 GHz ..... 110 dB
- 3 GHz to 6 GHz ..... 105 dB

### Typical Measurement Uncertainty<sup>3</sup>

The following graphs show the typical measurement uncertainty for the HP 8753D over the full frequency range using full two-port error correction.

### Transmission Measurements<sup>4</sup>

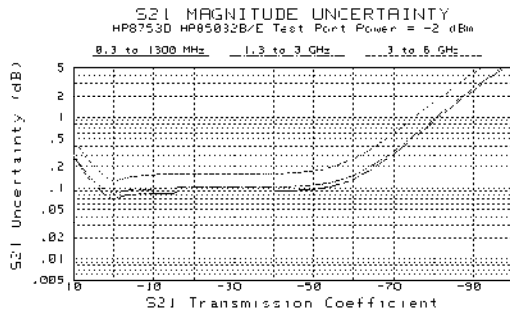

Magnitude

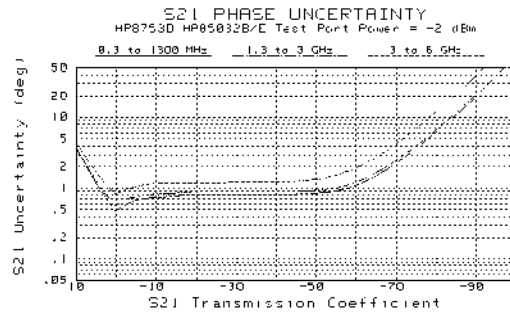

Phase

### Reflection Measurements<sup>5</sup>

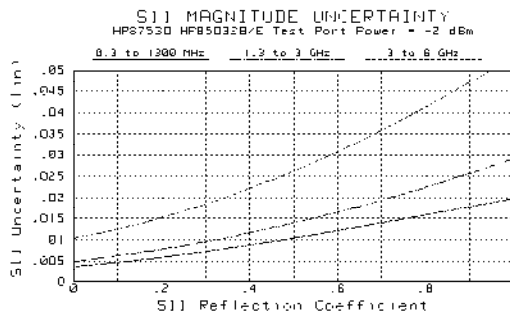

Magnitude

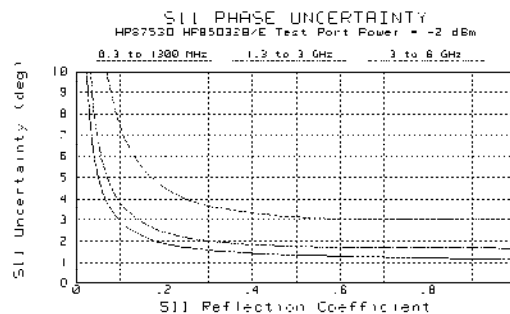

Phase

### Measurement Port Characteristics

The following specifications show the residual HP 8753D system uncertainties for corrected performance after accuracy enhancement using full two-port error correction. These characteristics apply for an environmental temperature of 25 ± 5°C, with less than 1°C deviation from the calibration temperature.

Corrected	Frequency Range			
	30 kHz-300 kHz <sup>2</sup>	300 kHz-1.3 GHz	1.3 GHz-3 GHz	3 GHz-6 GHz
Directivity	50 dB	50 dB	47 dB	40 dB
Source Match	49 dB	42 dB	36 dB	31 dB
Load Match	50 dB	50 dB	47 dB	40 dB
Refl. tracking	±0.005 dB	±0.009 dB	±0.019 dB	±0.070 dB
Trans. tracking	±0.014 dB	±0.013 dB	±0.026 dB	±0.065 dB

# System Performance Summary

## HP 8753D (50 ohm systems) 3.5 mm Test Ports

The following specifications describe the system performance of the HP 8753D network analyzer with an integrated 50 ohm s-parameter test set configuration. System hardware includes the following:

- Network analyzer: HP 8753D Option 006
- Calibration kit: HP 85033D
- Test port cables: HP 11857D

### Dynamic Range

These specifications apply to transmission measurements in the 30 kHz to 6 GHz frequency range at 10 Hz IF BW with full two-port error correction. Dynamic range is limited by maximum receiver input level and the receiver's noise floor.

### System dynamic range

- 30 kHz to 300 kHz ..... 100 dB<sup>1</sup>
- 300 kHz to 1.3 GHz ..... 110 dB<sup>2</sup>
- 1.3 GHz to 3 GHz ..... 110 dB
- 3 GHz to 6 GHz ..... 105 dB

### Typical Measurement Uncertainty<sup>3</sup>

The following graphs show the typical measurement uncertainty for the HP 8753D over the full frequency range using full two-port error correction.

### Transmission Measurements<sup>4</sup>

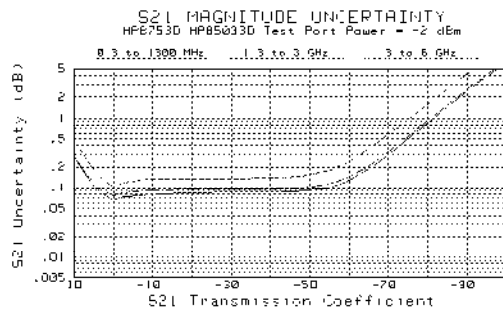

Magnitude

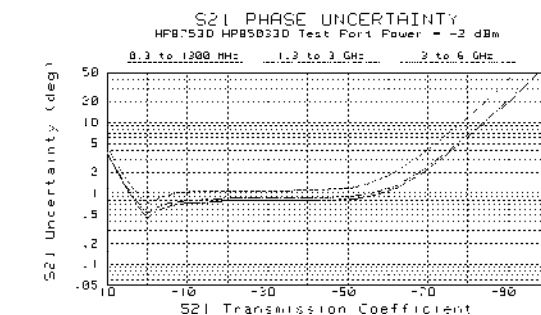

Phase

### Reflection Measurements<sup>5</sup>

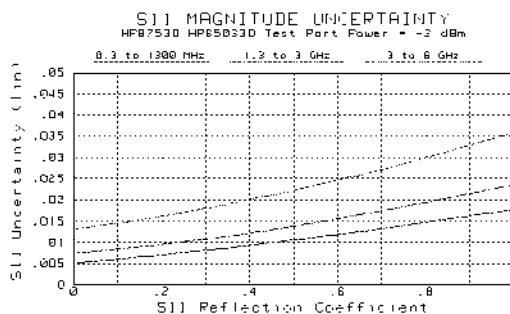

Magnitude

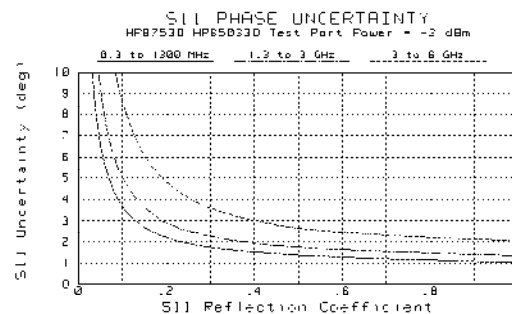

Phase

### Measurement Port Characteristics

The following specifications show the residual HP 8753D system uncertainties for corrected performance after accuracy enhancement using full two-port error correction. These characteristics apply for an environmental temperature of 25 ± 5°C, with less than 1°C deviation from the calibration temperature.

Corrected	Frequency Range			
	30 kHz-300 kHz <sup>2</sup>	300 kHz-1.3 GHz	1.3 GHz-3 GHz	3 GHz-6 GHz
Directivity	49 dB	46 dB	44 dB	38 dB
Source Match	49 dB	44 dB	41 dB	37 dB
Load Match	49 dB	46 dB	44 dB	38 dB
Refl. tracking	±0.010 dB	±0.005 dB	±0.007 dB	±0.009 dB
Trans. tracking	±0.016 dB	±0.014 dB	±0.022 dB	±0.048 dB

# System Performance Summary

## HP 8753D (75 ohm systems) Type-N Test Ports

The following specifications describe the system performance of the HP 8753D network analyzer with an integrated 75 ohm s-parameter test configuration. System hardware includes the following:

- Network analyzer: HP 8753D Option 075
- Calibration kit: HP 85036B
- Test port cables: HP 11857B

### Dynamic Range

These specifications apply to transmission measurements in the 30 kHz to 3 GHz frequency range at 10 Hz IF BW with full two-port error correction. Dynamic range is limited by maximum receiver input level and the receivers noise floor.

### System dynamic range:

- 30 kHz to 300 kHz ..... 95 dB<sup>1</sup>
- 300 kHz to 1.3 GHz ..... 105 dB<sup>2</sup>
- 1.3 GHz to 3 GHz ..... 105 dB

### Typical Measurement Uncertainty<sup>3</sup>

The following graphs show the typical measurement uncertainty for the HP 8753D over the full frequency range using full two-port error correction.

### Transmission Measurements<sup>4</sup>

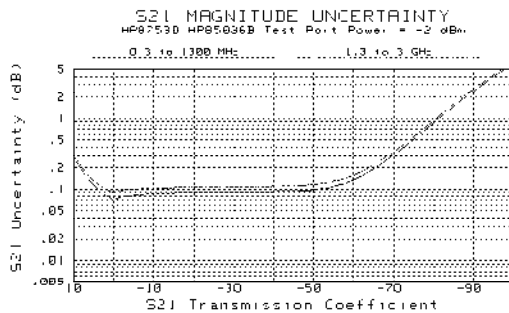

Magnitude

### Measurement Port Characteristics

The following specifications show the residual HP 8753D system uncertainties for uncorrected performance and after accuracy enhancement using full two-port error correction. These characteristics apply for an environmental temperature of 25 ± 5°C, with less than 1°C deviation from the calibration temperature.

Corrected <sup>6</sup>	Frequency Range		
	30 kHz - 300 kHz	300 kHz - 1.3 GHz	1.3 GHz - 3 GHz
Directivity	48 dB	48 dB	43 dB
Source Match	47 dB	41 dB	35 dB
Load Match	48 dB	48 dB	43 dB
Reflection tracking	±0.004 dB	±0.010 dB	±0.019 dB
Trans. tracking	±0.018 dB	±0.015 dB	±0.033 dB
Uncorrected <sup>6</sup>			
Directivity	34 dB	35 dB	30 dB
Source Match	10 dB	16 dB	16 dB
Load Match	14 dB	18 dB	16 dB
Reflection tracking	± 2.0 dB	± 1.5 dB	± 1.5 dB
Trans. tracking	± 2.0 dB	± 1.5 dB	± 1.5 dB
Crosstalk	100 dB	100 dB	100 dB

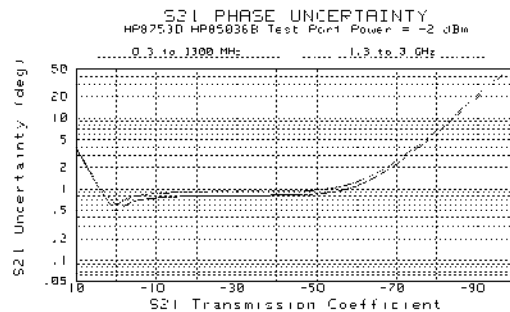

Phase

### Reflection Measurements<sup>5</sup>

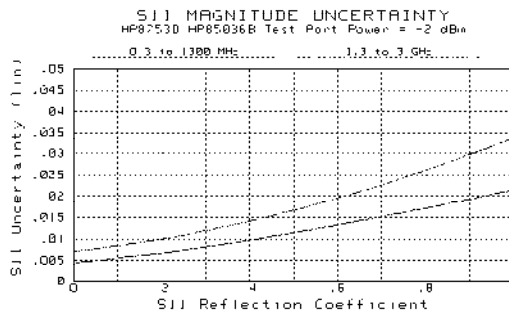

Magnitude

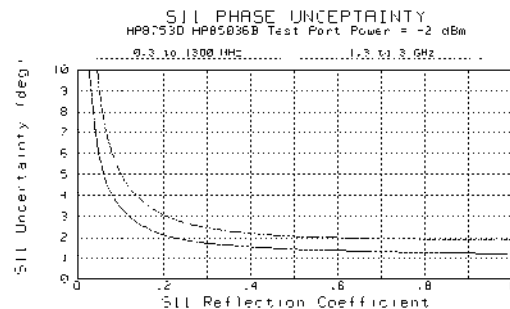

Phase

# System Performance Summary

## HP 8753D (75 ohm systems) Type-F Test Ports

The following specifications describe the system performance of the HP 8753D network analyzer with an integrated 75 ohm s-parameter test configuration. System hardware includes the following:

- Network analyzer: HP 8753D Option 075
- Calibration kit: HP 85039A
- Test port cables: HP 11857B

### Dynamic Range

These specifications apply to transmission measurements in the 30 kHz to 3 GHz frequency range at 10 Hz IF BW with full two-port error correction. Dynamic range is limited by maximum receiver input level and the receiver's noise floor.

### System dynamic range:

- 30 kHz to 300 kHz ..... 95 dB<sup>1</sup>
- 300 kHz to 1.3 GHz ..... 105 dB<sup>2</sup>
- 1.3 GHz to 3 GHz ..... 105 dB

### Typical Measurement Uncertainty<sup>3</sup>

The following graphs show the typical measurement uncertainty for the HP 8753D over the full frequency range using full two-port error correction.

### Transmission Measurements<sup>4</sup>

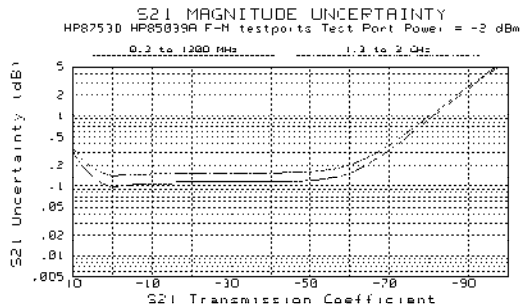

### Measurement Port Characteristics

The following specifications show the residual HP 8753D system uncertainties for uncorrected performance and after accuracy enhancement using full two-port error correction. These characteristics apply for an environmental temperature of 25 ± 5°C, with less than 1°C deviation from the calibration temperature. Data is shown for type-F female reflection port and type-F male transmission port.

Corrected <sup>4</sup>	Frequency Range		
	30 kHz-300 kHz	300 kHz-1.3 GHz	1.3 GHz-3 GHz
Directivity	38 dB	38 dB	32 dB
Source Match	36 dB	36 dB	30 dB
Load Match	38 dB	38 dB	32 dB
Refl. tracking	±0.008 dB	±0.008 dB	±0.032 dB
Trans. tracking	±0.062 dB	±0.035 dB	±0.078 dB

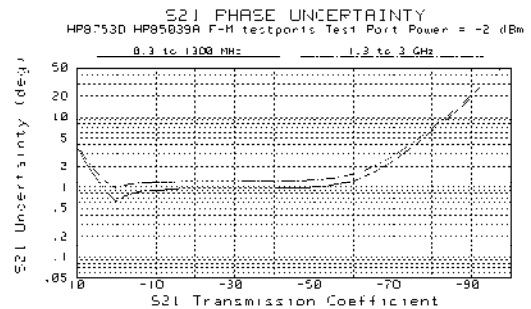

### Magnitude

### Phase

### Reflection Measurements<sup>5</sup>

### Magnitude

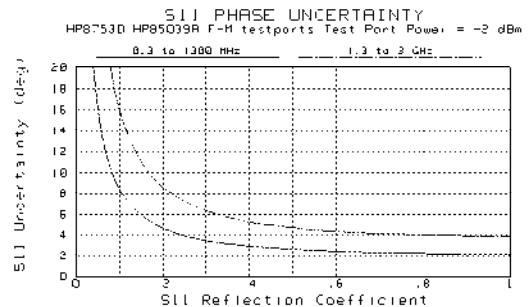
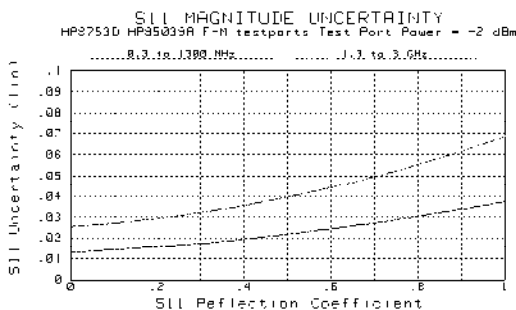

### Phase

# System Performance Summary

## HP 8752C (50 ohm systems) Type-N Test Ports

The following specifications describe the system performance of the HP 8752C 50 ohm network analyzer. System hardware includes the following (a transmission/reflection test set is built into the analyzer, and the cable is shipped with the HP 8752C):

- Network analyzer: HP 8752C Option 006
- Calibration kit: HP 85032B
- Test port cable: HP part number 8120-5639

### Dynamic Range

These specifications apply to transmission measurements in the 300 kHz to 6 GHz frequency range at 10 Hz IF BW with response and isolation correction. Dynamic range is limited by maximum receiver input level and the receiver's noise floor.

### System dynamic range:

- 300 kHz to 1.3 GHz ..... 110 dB<sup>2</sup>
- 1.3 GHz to 3 GHz ..... 110 dB
- 3 GHz to 6 GHz ..... 105 dB

### Typical Measurement Uncertainty<sup>3</sup>

The following graphs show the typical measurement uncertainty for the HP 8752C over the full frequency range with error correction. Total uncertainties can be improved using one-port error correction for reflection measurements, and response and isolation error correction for transmission measurements.

### Transmission Measurements<sup>4</sup>

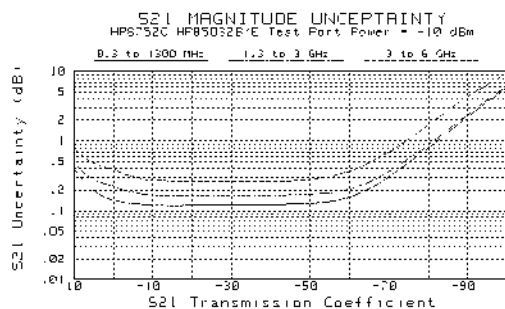

### Magnitude

### Measurement Port Characteristics

The following specifications show the residual HP 8752C system uncertainties with and without error correction. These characteristics apply for an environmental temperature of 25 ± 5°C, with less than 1°C deviation from the calibration temperature. Option 004 may degrade transmission source match as much as 2 dB, resulting in up to 0.05 dB additional uncertainty in transmission tracking.

Corrected	Frequency Range		
	300 kHz-1.3 GHz	1.3 GHz-3.0 GHz	3.0 GHz-6.0 GHz
Directivity	50 dB	47 dB	40 dB
Source match (Reflection)	42 dB	36 dB	31 dB
Reflection tracking	±0.009 dB	±0.019 dB	±0.070 dB
Source match (Trans.)	23 dB	20 dB	20 dB
Load match	23 dB*	20 dB	20 dB
Trans. tracking	±0.043 dB*	±0.086 dB	±0.137 dB
<b>Uncorrected</b>			
Directivity	40 dB**	35 dB	30 dB
Source match (Reflection)	30 dB	25 dB	20 dB
Reflection tracking	±0.2 dB	±0.3 dB	±0.4 dB
Source match (Trans.)	23 dB	20 dB	16 dB
Load match	23 dB*	20 dB	20 dB
Trans. tracking	±0.2 dB	±0.3 dB	±0.4 dB
Crosstalk	100 dB	100 dB	90 dB

\* Load match is 14 dB from 300 kHz to 10 MHz for Option 006, resulting in transmission tracking of ±0.13 dB.

\*\* 30 dB, 300 kHz to 10 MHz

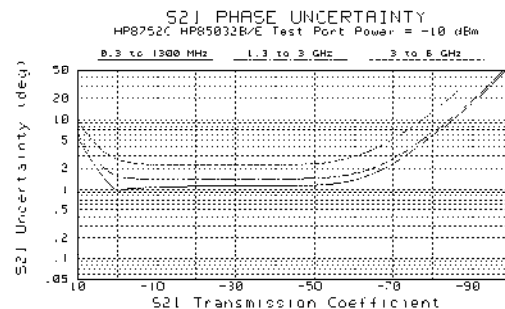

### Phase

### Reflection Measurements<sup>5</sup>

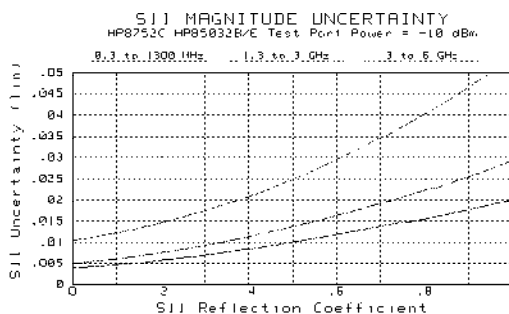

### Magnitude

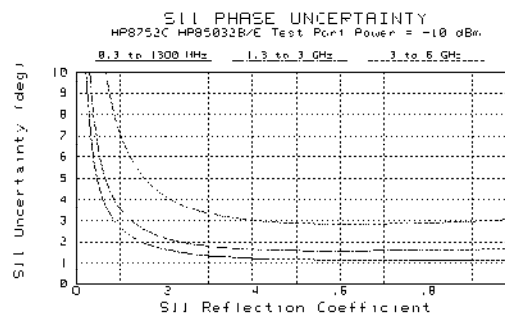

### Phase



# System Performance Summary

## HP 8752C (50 ohm systems) 3.5 mm Test Ports

The following specifications describe the system performance of the HP 8752C 50 ohm network analyzer. System hardware includes the following (a transmission/reflection test set is built into the analyzer, and the cable is included with the HP 8752C):

- Network analyzer: HP 8752C Option 006
- Calibration kit: HP 85033D (Option 001)
- Test port cable: HP part number 8120-5639

### Dynamic Range

These specifications apply to transmission measurements in the 300 kHz to 6 GHz frequency range at 10 Hz IF BW with response and isolation correction. Dynamic range is limited by maximum receiver input level and the receiver's noise floor.

### System dynamic range:

- 300 kHz to 1.3 GHz ..... 110 dB<sup>2</sup>
- 1.3 GHz to 3 GHz ..... 110 dB
- 3 GHz to 6 GHz ..... 105 dB

### Typical Measurement Uncertainty<sup>3</sup>

The following graphs show the typical measurement uncertainty for the HP 8752C over the full frequency range with error correction. Total uncertainties can be improved using one-port error correction for reflection measurements, and response and isolation error correction for transmission measurements.

### Transmission Measurements<sup>4</sup>

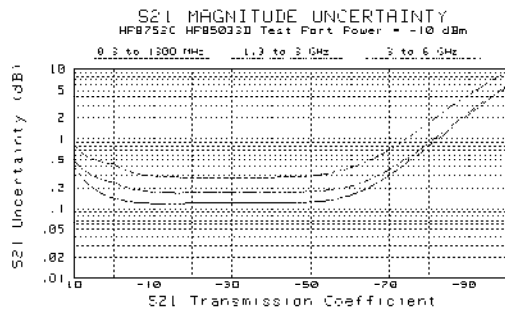

#### Magnitude

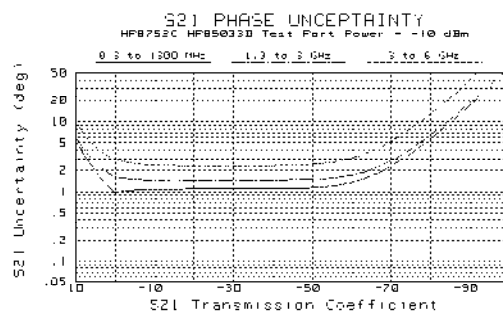

#### Phase

### Reflection Measurements<sup>5</sup>

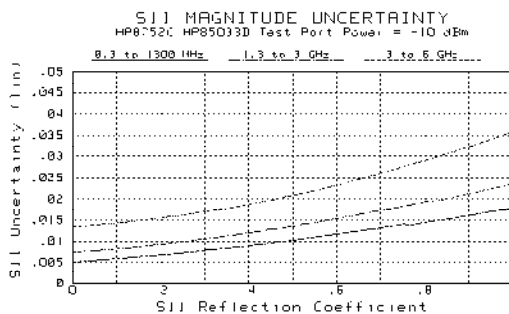

#### Magnitude

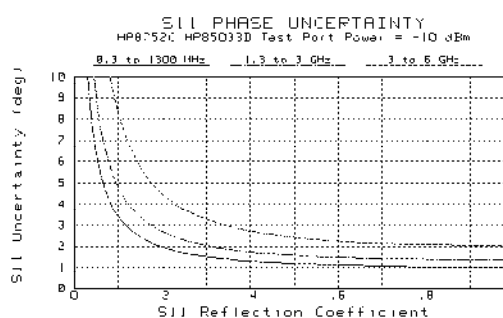

#### Phase

### Measurement Port Characteristics

The following specifications show the residual HP 8752C system uncertainties with error correction. These characteristics apply for an environmental temperature of 25 ± 5°C, with less than 1°C deviation from the calibration temperature. Option 004 may degrade source match as much as 2 dB, resulting in up to 0.05 dB additional uncertainty in transmission tracking.

Corrected <sup>a</sup>	Frequency Range		
	300 kHz-1.3 GHz	1.3 GHz-3.0 GHz	3.0 GHz-6.0 GHz
Directivity	46 dB	43 dB	37 dB
Source match (Reflection)	44 dB	41 dB	36 dB
Reflection tracking	±0.005 dB	±0.006 dB	±0.009 dB
Source match (Trans.)	22 dB	19 dB	15 dB
Load match	22 dB*	19 dB	19 dB
Trans. tracking	±0.047 dB*	±0.096 dB	±0.155 dB

\* Load match is 14 dB from 300 kHz to 10 MHz for Option 006, resulting in transmission tracking of ±0.13 dB.

# System Performance Summary

## HP 8752C (75 ohm systems) Type-N Test Ports

The following specifications describe the system performance of the HP 8752C 75 ohm network analyzer. System hardware includes the following (a transmission/reflection test set is built into the analyzer, and the cable is shipped with the HP 8752C):

- Network analyzer: HP 8752C Option 075
- Calibration kit: HP 85036B
- Test port cable: HP part number 8120-2408

### Dynamic Range

These specifications apply to transmission measurements in the 300 kHz to 3 GHz frequency range at 10 Hz IF BW with response and isolation correction. Dynamic range is limited by maximum receiver input level and the receiver's noise floor.

### System dynamic range:

- 300 kHz to 1.3 GHz ..... 105 dB<sup>2</sup>
- 1.3 GHz to 3 GHz ..... 105 dB

### Typical Measurement Uncertainty<sup>3</sup>

The following graphs show the typical measurement uncertainty for the HP 8752C over the full frequency range with error correction. Total uncertainties can be improved using one-port error correction for reflection measurements, and response and isolation error correction for transmission measurements.

### Measurement Port Characteristics

The following specifications show the residual HP 8752C system uncertainties with and without error correction. These characteristics apply for an environmental temperature of 25 ± 5°C, with less than 1°C deviation from the calibration temperature. Option 004 may degrade source match as much as 2 dB, resulting in up to 0.05 dB additional uncertainty in transmission tracking.

Corrected <sup>6</sup>	Frequency Range	
	300 kHz to 1.3 GHz	1.3 GHz to 3.0 GHz
Directivity	48 dB	43 dB
Source match (Reflection)	41 dB	35 dB
Reflection tracking	±0.010 dB	±0.019 dB
Source match (Trans.)	23 dB	20 dB
Load match	23 dB	20 dB
Trans. tracking	±0.044 dB	±0.087 dB
Uncorrected <sup>6</sup>		
Directivity	40 dB*	35 dB
Source match (Reflection)	30 dB	25 dB
Reflection tracking	±0.2 dB	±0.3 dB
Source match (Trans.)	23 dB	20 dB
Load match	23 dB	20 dB
Trans. tracking	±0.2 dB	±0.3 dB
Crosstalk	100 dB	97 dB

### Transmission Measurements<sup>4</sup>

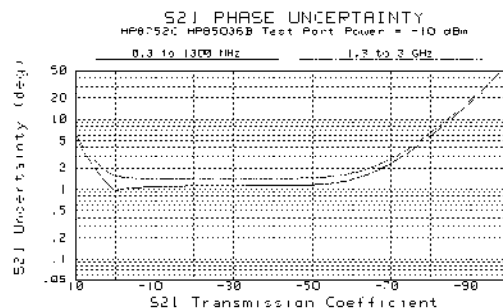
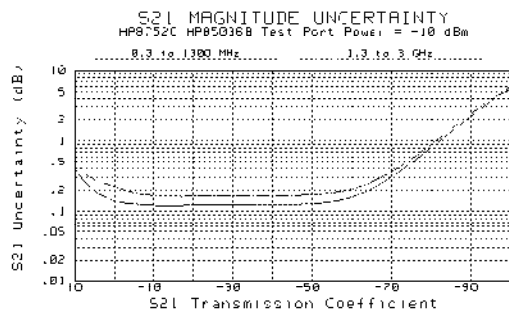

\* 30 dB from 300 kHz to 10 MHz

### Magnitude

### Phase

### Reflection Measurements<sup>5</sup>

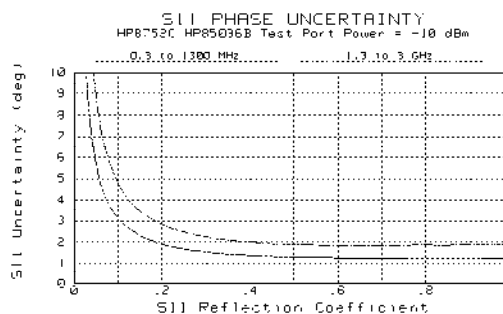
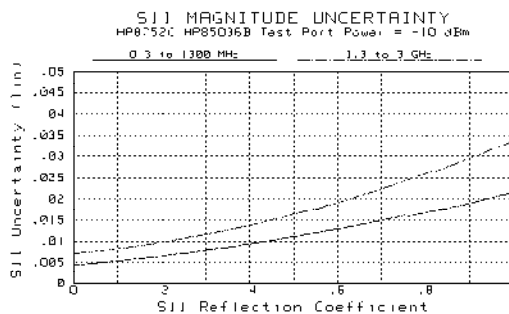

### Magnitude

### Phase

# System Performance Summary

## HP 8752C (75 ohm systems) Type-F Test Ports

The following specifications describe the system performance of the HP 8752C 75 ohm network analyzer. System hardware includes the following (a transmission/reflection test set is built into the analyzer, and the cable is shipped with the HP 8752C):

- Network analyzer: HP 8752C Option 075
- Calibration kit: HP 85039A
- Test port cable: HP part number 8120-2408

### Dynamic Range

These specifications apply to transmission measurements in the 300 kHz to 3 GHz frequency range at 10 Hz IF BW with response and isolation correction. Dynamic range is limited by maximum receiver input level and the receiver's noise floor.

### System dynamic range:

- 300 kHz to 1.3 GHz ..... 105 dB<sup>2</sup>
- 1.3 GHz to 3 GHz ..... 105 dB

### Typical Measurement Uncertainty<sup>3</sup>

The following graphs show the typical measurement uncertainty for the HP 8752C over the full frequency range with error correction. Total uncertainties can be improved using one-port error correction for reflection measurements, and response and isolation error correction for transmission measurements.

### Measurement Port Characteristics

The following specifications show the residual HP 8752C system uncertainties with and without error correction. These characteristics apply for an environmental temperature of 25 ± 5°C, with less than 1°C deviation from the calibration temperature. Option 004 may degrade source match as much as 2 dB, resulting in up to 0.05 dB additional uncertainty in transmission tracking. Data is shown for type-F female reflection port and type-F male transmission port.

Corrected <sup>6</sup>	Frequency Range	
	300 kHz to 1.3 GHz	1.3 GHz to 3.0 GHz
Directivity	38 dB	32 dB
Source match (Reflection)	36 dB	30 dB
Reflection tracking	±0.008 dB	±0.032 dB
Source match (Trans.)	21 dB	18 dB
Load match	21 dB	18 dB
Trans. tracking	±0.060 dB	±0.135 dB

### Transmission Measurements<sup>4</sup>

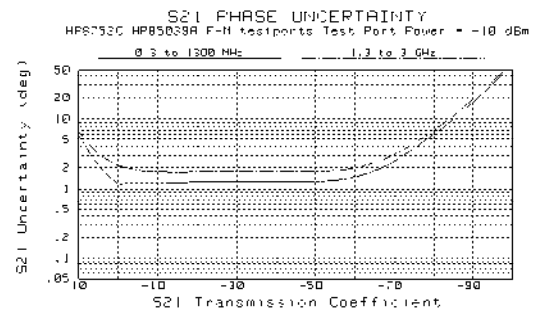
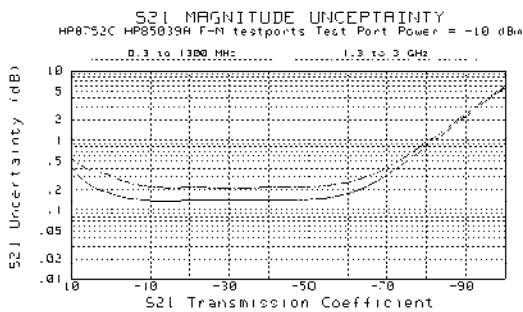

### Magnitude

### Phase

### Reflection Measurements<sup>5</sup>

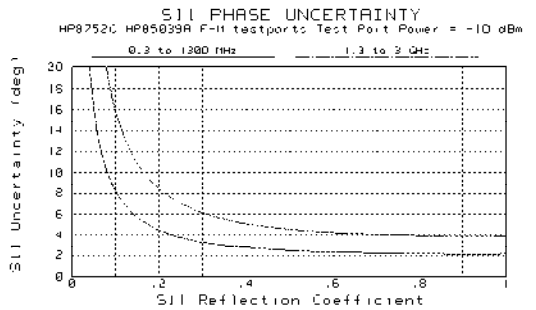
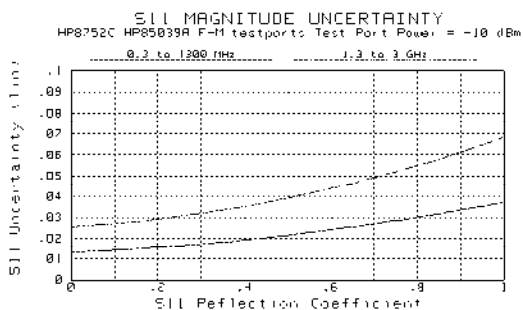

### Magnitude

# HP 8753D Specifications

## Test Port Output Characteristics

### Frequency Characteristics

**Range:** 30 kHz to 3 GHz (6 GHz with Opt. 006)  
**Resolution:** 1 Hz  
**Stability:** typically  $\pm 7.5$  ppm  $0^\circ$  to  $55^\circ\text{C}$   
 typically  $\pm 3$  ppm/year  
**With Option 1D5:**  
 typically  $\pm 0.05$  ppm  $0^\circ$  to  $55^\circ\text{C}$   
 typically  $\pm 0.5$  ppm/year  
**Accuracy:**  $\pm 10$  ppm at  $25^\circ\text{C} \pm 5^\circ\text{C}$   
**Power range:** -85 to +10 dBm  
**Resolution:** 0.05 dB  
**Level accuracy<sup>7,25;</sup>**  $\pm 1.0$  dB  
**Level linearity<sup>7,8,25;</sup>** (-15 dBm to +5 dBm)  $\pm 0.2$  dB  
 (5 dBm to 10 dBm)  $\pm 0.5$  dB

**Impedance:** 50 $\Omega$ ; typically  
 $\geq 16$  dB RL (<1.38 SWR) to 3 GHz  
 $\geq 14$  dB RL (<1.50 SWR) to 6 GHz

**Spectral purity:**  
**2nd harmonic<sup>9;</sup>** < -25 dBc at 10 dBm  
 < -40 dBc at 0 dBm (typical)  
 < -50 dBc at -10 dBm (typical)  
**3rd harmonic<sup>10;</sup>** < -25 dBc at 10 dBm  
 < -40 dBc at 0 dBm (typical)  
 < -50 dBc at -10 dBm (typical)

**Nonharmonic spurious:**  
**Mixer related:** < -30 dBc at 10 dBm (typical)  
 < -55 dBc at -10 dBm (typical)

## Test Port Input Characteristics

**Frequency range:** 30 kHz to 3 GHz (6 GHz with Opt. 006)  
**Average noise level:** -82 dBm (3 kHz BW, <3 GHz)  
 -102 dBm (10 Hz BW, <3 GHz)  
 -110 dBm (10 Hz BW, <3 GHz) (typical)  
 -77 dBm (3 kHz BW, 3 to 6 GHz)  
 -97 dBm (10 Hz BW, 3 to 6 GHz)  
 -105 dBm (10 Hz BW, 3 to 6 GHz) (typical)

**Maximum input level:** 10 dBm  
**Damage level:** 26 dBm or 35 VDC  
**Impedance: 50 ohms:**  $\geq 10$  dB RL, 30 kHz to 50 kHz  
 $\geq 20$  dB RL, 50 kHz to 300 kHz  
 $\geq 18$  dB RL, 300 kHz to 1.3 GHz  
 $\geq 16$  dB RL, 1.3 GHz to 3 GHz  
 $\geq 14$  dB RL, 3 GHz to 6 GHz

**Frequency response<sup>25;</sup>**  $\pm 1.0$  dB, 300 kHz to 3 GHz  
 ( $25^\circ \pm 5^\circ\text{C}$ )  $\pm 2.0$  dB, 3 GHz to 6 GHz

**Harmonics (Option 002):**  
**2nd harmonic:** < -15 dBc at +8 dBm  
 < -30 dBc at 0 dBm (typical)  
 < -45 dBc at -15 dBm (typical)  
**3rd harmonic:** < -30 dBc at +8 dBm  
 < -50 dBc at 0 dBm (typical)  
 < -50 dBc at -15 dBm (typical)

**Harmonic Measurement Accuracy: ( $25^\circ \pm 5^\circ\text{C}$ )**  
 16 MHz to 3 GHz  $\pm 1$  dB  
 3 GHz to 6 GHz:  $\pm 3$  dB (With Opt. 006)

**Harmonic Measurement Dynamic Range:**  
 -40 dBc (output = -10 dBm, input < -15 dBm)

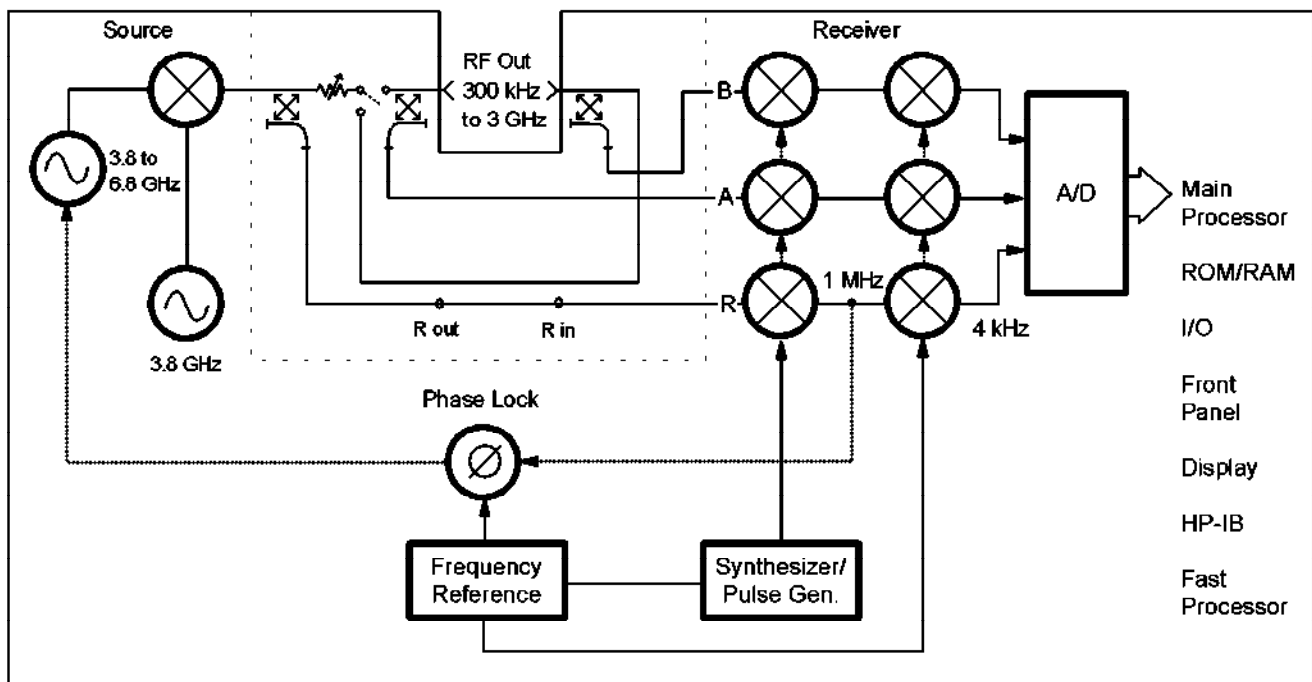

HP 8753D Block Diagram

# HP 8753D Specifications

## Test Port Input Characteristics (continued)

### Frequency Offset Mode<sup>11</sup>

<b>Frequency range:</b>	300 kHz to 3 GHz (6 GHz with Opt. 006)
<b>R channel input requirements:</b>	
<b>Power level:</b>	0 to -35 dBm to 3 GHz 0 to -30 dBm, 3 GHz to 6 GHz
<b>Spectral purity:</b>	
<b>Maximum spurious input:</b>	<-25 dBc
<b>Residual FM:</b>	<20 kHz
<b>LO Frequency accuracy:</b>	-1 to +1 MHz of nominal frequency

### External Source Mode<sup>12</sup> (CW Time sweep only)

<b>Frequency range:</b>	300 kHz to 6 GHz
<b>R channel input requirements<sup>1</sup>:</b>	
<b>Power level:</b>	0 to -25 dBm
<b>Spectral purity:</b>	
<b>Maximum spurious input:</b>	<-30 dBc
<b>Residual FM:</b>	<20 kHz
<b>Typical settling time:</b>	500 ms (auto) 50 ms (manual)
<b>Frequency readout accuracy:</b>	0.1% typical (auto)
<b>Input frequency margin<sup>1</sup>:</b>	Manual: -0.5 to 5 MHz Auto: ≤50 MHz, ±5 MHz >50 MHz, ±10% CW freq.
<b>Accuracy:</b>	(See Magnitude and Phase Characteristics)

## Magnitude Characteristics

**Dynamic accuracy:**  
(10 Hz IF BW)

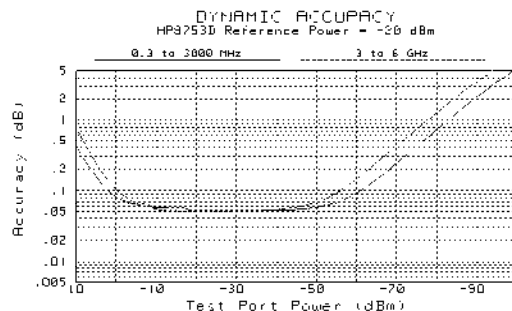

<b>Display resolution:</b>	0.001 dB/division
<b>Marker resolution<sup>13</sup>:</b>	0.001 dB
<b>Trace noise:</b>	< 0.006 dB rms, 30 kHz to 3 GHz < 0.010 dB rms, 3 GHz to 6 GHz (+5 dBm at test port, ratio measurement, 3 kHz BW)
<b>Reference level:</b>	Range: ± 500 dB Resolution: 0.001 dB
<b>Stability:</b>	0.02 dB/°C, 30 kHz to 3 GHz (typical) 0.04 dB/°C, 3 GHz to 6 GHz (typical)

## Phase Characteristics

**Dynamic accuracy:**  
(10 Hz IF BW)

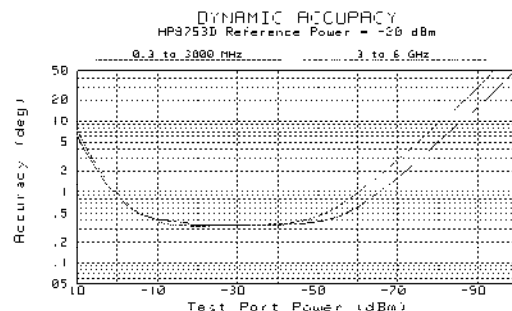

<b>Range:</b>	±180 degrees
<b>Display resolution:</b>	0.01°/division
<b>Marker resolution<sup>13</sup>:</b>	0.01°
<b>Trace noise:</b>	< 0.038° rms to 3 GHz < 0.070° rms to 6 GHz (5 dBm at test port, ratio measurement, 3 kHz BW)
<b>Reference level:</b>	Range: ± 500 degrees Resolution: 0.01 degree
<b>Stability:</b>	0.05°/°C, 30 kHz to 3 GHz (typical) 0.20°/°C, 3 GHz to 6 GHz (typical)
<b>Polar Characteristics</b>	
<b>Range:</b>	10 x 10 <sup>-12</sup> to 1000 units full scale
<b>Reference:</b>	± 500 units

# HP 8753D Option 011 Specifications

## Test Port Output Characteristics

### Frequency Characteristics

**Range:** 300 kHz to 3 GHz  
30 kHz to 6 GHz (with Option 006)

**Resolution:** 1 Hz

**Stability:** typically  $\pm 7.5$  ppm  $0^\circ$  to  $55^\circ\text{C}$   
typically  $\pm 3$  ppm/year

**With Option 1D5:**  
typically  $\pm 0.05$  ppm  $0^\circ$  to  $55^\circ\text{C}$   
typically  $\pm 0.5$  ppm/year

**Accuracy:**  $\pm 10$  ppm at  $25^\circ\text{C} \pm 5^\circ\text{C}$

**Power range:** -5 to +20 dBm  
-5 to +18 dBm (with Option 006)

**Resolution:** 0.05 dB

**Level accuracy<sup>7</sup>:**  $\pm 1.0$  dB

**Level linearity<sup>7,8,24</sup>:** (-5 dBm to +15 dBm)  $\pm 0.25$  dB  
(+15 dBm to +20 dBm)  $\pm 0.5$  dB

**Impedance:** 50 $\Omega$ ; typically  
 $\geq 16$  dB RL (<1.38 SWR) to 3 GHz  
 $\geq 14$  dB RL (<1.50 SWR) to 6 GHz

**Spectral purity:**

**2nd harmonic<sup>9</sup>:** < -25 dBc at 20 dBm  
< -40 dBc at 10 dBm (typical)  
< -50 dBc at 0 dBm (typical)

**3rd harmonic<sup>10</sup>:** < -25 dBc at 20 dBm  
< -40 dBc at 10 dBm (typical)  
< -50 dBc at 0 dBm (typical)

**Nonharmonic spurious:**

**Mixer related:** < -30 dBc at 20 dBm (typical)  
< -55 dBc at 0 dBm (typical)

## Test Port Input Characteristics

**Frequency range:** 300 kHz to 3 GHz  
30 kHz to 6 GHz (with Option 006)

**Average noise level:** -90 dBm (3 kHz BW, 50 kHz to 3 GHz)  
-110 dBm (10 Hz BW, 50 kHz to 3 GHz)  
-120 dBm (10 Hz BW, 50 kHz to 3 GHz) (typical)  
-85 dBm (3 kHz BW, 3 to 6 GHz)  
-105 dBm (10 Hz BW, 3 to 6 GHz)  
-115 dBm (10 Hz BW, 3 to 6 GHz) (typical)

**Maximum input level:** 0 dBm

**Damage level:** 20 dBm or 35 VDC

**Impedance: 50 ohms:**  $\geq 10$  dB RL, 30 kHz to 50 kHz  
 $\geq 20$  dB RL, 50 kHz to 300 kHz  
 $\geq 23$  dB RL, 300 kHz to 1.3 GHz  
 $\geq 20$  dB RL, 1.3 GHz to 3 GHz  
 $\geq 8$  dB RL, 3 GHz to 6 GHz

**Frequency response:**  $\pm 1.0$  dB, 300 kHz to 3 GHz  
( $25^\circ \pm 5^\circ\text{C}$ )  
 $\pm 2.0$  dB, 3 GHz to 6 GHz

**Harmonics (Option 002):**

**2nd harmonic:** < -15 dBc at 0 dBm  
< -35 dBc at -10 dBm (typical)  
< -45 dBc at -30 dBm (typical)

**3rd harmonic:** < -30 dBc at 0 dBm  
< -50 dBc at -10 dBm (typical)  
< -50 dBc at -30 dBm (typical)

**Harmonic Measurement Accuracy: ( $25^\circ \pm 5^\circ\text{C}$ )**  
16 MHz to 3 GHz  $\pm 1$  dB  
3 GHz to 6 GHz:  $\pm 3$  dB (With Option 006)

**Harmonic Measurement Dynamic Range:**  
-40 dBc (output = -10 dBm, input < -15 dBm)

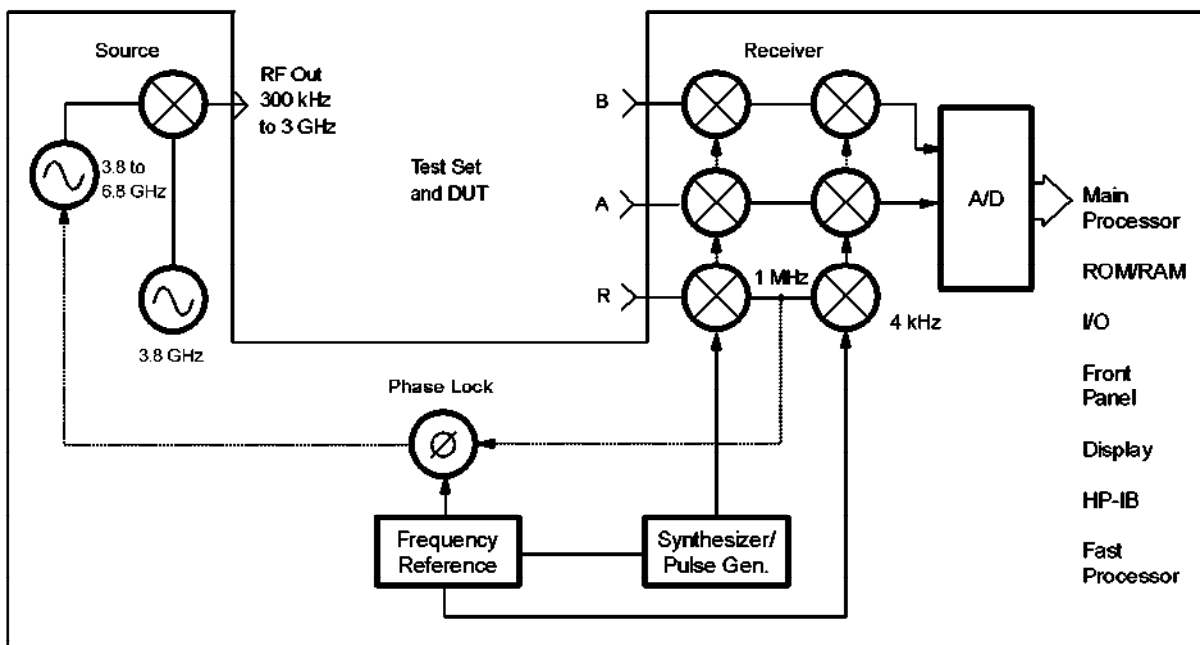

HP 8753D Option 011 Block Diagram

# HP 8752C Specification

## Test Port Input Characteristics (continued)

### Frequency Offset Mode<sup>11</sup>

<b>Frequency range:</b>	300 kHz to 3 GHz (6 GHz with Opt. 006)
<b>R channel input requirements:</b>	
<b>Power level:</b>	0 to -35 dBm to 3 GHz 0 to -30 dBm, 3 GHz to 6 GHz
<b>Spectral purity:</b>	
<b>Maximum spurious input:</b>	<-25 dBc
<b>Residual FM:</b>	<20 kHz
<b>LO Frequency accuracy:</b>	-1 to +1 MHz of nominal frequency

### External Source Mode<sup>12</sup> (CW Time sweep only)

<b>Frequency range:</b>	300 kHz to 6 GHz
<b>R channel input requirements*:</b>	
<b>Power level:</b>	0 to -25 dBm
<b>Spectral purity:</b>	
<b>Maximum spurious input:</b>	<-30 dBc
<b>Residual FM:</b>	<20 kHz
<b>Typical settling time:</b>	500 ms (auto) 50 ms (manual)
<b>Frequency readout accuracy:</b>	0.1% typical (auto)
<b>Input frequency margin*:</b>	Manual: -0.5 to 5 MHz Auto: ≤50 MHz, ±5 MHz >50 MHz, ±10% CW freq.
<b>Accuracy:</b>	(See Magnitude and Phase Characteristics)

## Magnitude Characteristics

**Dynamic accuracy:**  
(10 Hz IF BW, inputs A or B; applies to R for ≥ -35 dBm)

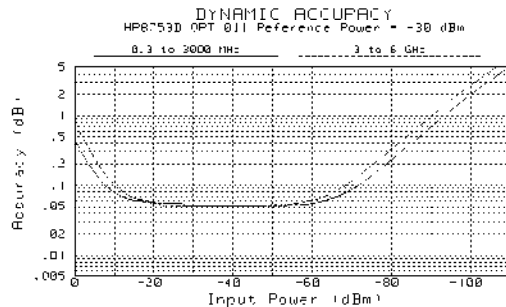

<b>Display resolution:</b>	0.001 dB/division
<b>Marker resolution<sup>13</sup>:</b>	0.001 dB
<b>Trace noise:</b>	< 0.006 dB rms, 30 kHz to 3 GHz < 0.010 dB rms, 3 GHz to 6 GHz (+5 dBm at test port, ratio measurement, 3 kHz BW)
<b>Reference level:</b>	Range: ± 500 dB Resolution: 0.001 dB
<b>Stability:</b>	0.02 dB/°C, 30 kHz to 3 GHz (typical) 0.04 dB/°C, 3 GHz to 6 GHz (typical)

## Phase Characteristics

**Dynamic accuracy:**  
(10 Hz IF BW, inputs A or B; applies to R for ≥ -35 dBm)

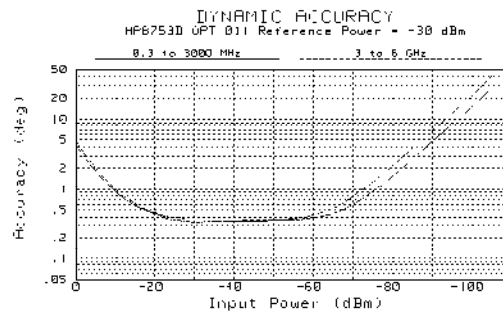

<b>Range:</b>	±180 degrees
<b>Display resolution:</b>	0.01°/division
<b>Marker resolution<sup>13</sup>:</b>	0.01°
<b>Trace noise:</b>	< 0.038° rms to 3 GHz < 0.070° rms to 6 GHz (5 dBm at test port, ratio measurement, 3 kHz BW)
<b>Reference level:</b>	Range: ± 500 degrees Resolution: 0.01 degree
<b>Stability:</b>	0.05°/°C, 30 kHz to 3 GHz (typical) 0.20°/°C, 3 GHz to 6 GHz (typical)
<b>Polar Characteristics</b>	
<b>Range:</b>	10 x 10 <sup>-12</sup> to 1000 units full scale
<b>Reference:</b>	± 500 units

# HP 8752C Specification

## Test Port Output Characteristics

### Frequency Characteristics

<b>Range:</b>	300 kHz to 1.3 GHz
<b>Option 003:</b>	300 kHz to 3 GHz
<b>Option 006:</b>	300 kHz to 6 GHz
<b>Resolution:</b>	1 Hz
<b>Stability:</b>	±7.5 ppm 0°C to 55°C
<b>Accuracy:</b>	± 10 ppm at 25°C ± 5°C

### Output Characteristics

<b>Test port power range:</b>	-20 to +5 dBm (standard)
	-85 to +10 dBm (Option 004)
	-85 to +8 dBm (Options 004 and 075)

<b>Resolution:</b>	0.05 dB
<b>Level accuracy:<sup>7,25</sup></b>	±1.0 dB
<b>Level linearity:<sup>7,25</sup></b>	(-20 to -15 dBm) ±0.5 dB
	(-15 to 0 dBm) ±0.2 dB
	(0 to +5 dBm) ±0.5 dB
<b>Option 004:</b>	(-15 to +5 dBm) ±0.2 dB
	(+5 to +10 dBm) ±0.5 dB

<b>Impedance:</b>	50Ω nominal
	75Ω nominal (Option 075)

## Test Port Input Characteristics

<b>Frequency range:</b>	300 kHz to 1.3 GHz	
<b>Option 003:</b>	300 kHz to 3 GHz	
<b>Option 006:</b>	300 kHz to 6 GHz	
<b>Noise level:</b>		
3 kHz BW	Reflection	-75 dBm (typical)
10 Hz BW	Reflection	-85 dBm (typical)
3 kHz BW	Transmission	-90 dBm
10 Hz BW	Transmission	-110 dBm

### Option 006, from 3 GHz to 6 GHz:

3 kHz BW	Transmission	-85 dBm
10 Hz BW	Transmission	-105 dBm

<b>Max. input level:</b>	0 dBm at transmission port
	10 dBm at reflection port

<b>Damage level:</b>	<b>Standard, Opt. 003, or Option 075:</b>
	20 dBm or 25 VDC at both test ports
	<b>Option 006:</b>
	20 dBm or 25 VDC at reflection port
	20 dBm or 10 VDC at transmission port

<b>Crosstalk:</b>		
(Reflection port to transmission port)	300 kHz to 1.3 GHz	100 dB
	1.3 to 3 GHz	100 dB
	3 GHz to 6 GHz	90 dB
	<b>Option 075:</b>	
	300 kHz to 1.3 GHz	100 dB
	1.3 to 3 GHz	97 dB

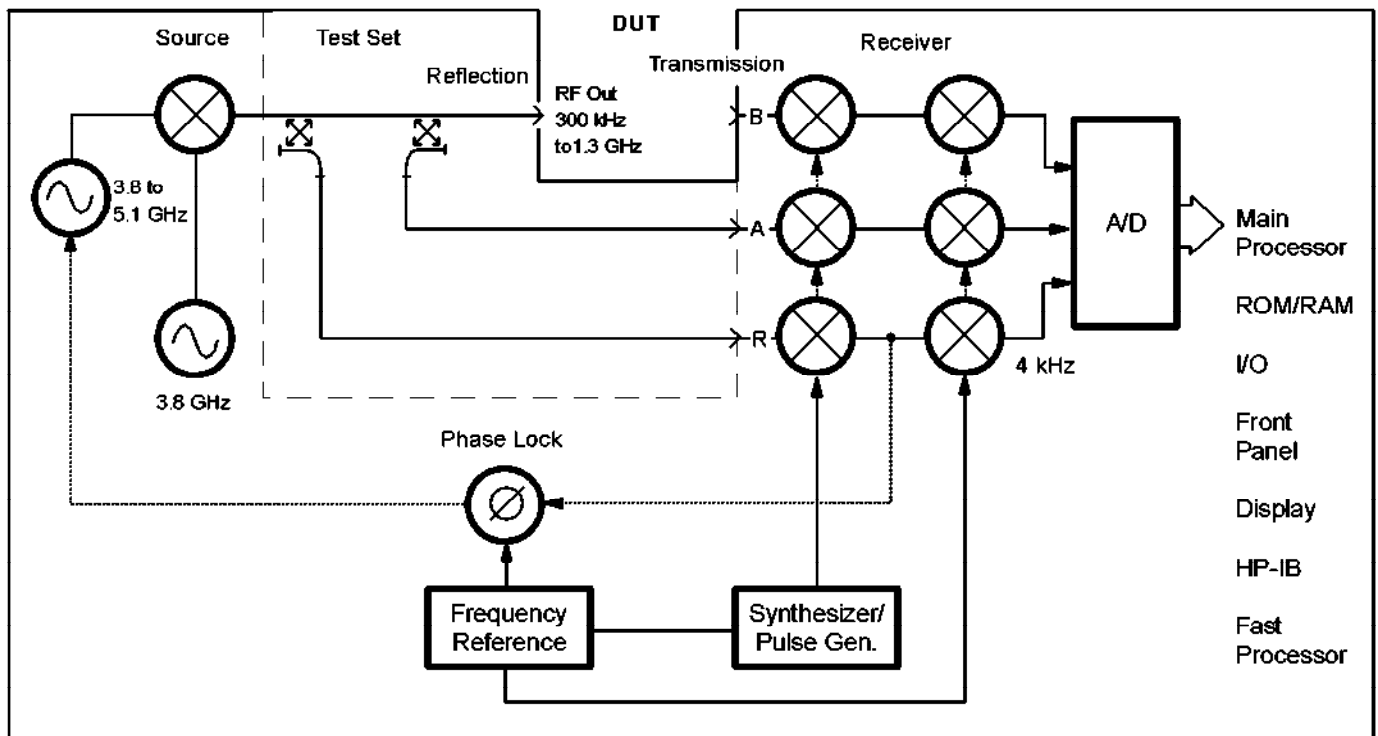

HP 8752C Block Diagram



# HP 8752C Specifications (continued)

## Magnitude Characteristics

### Dynamic Accuracy

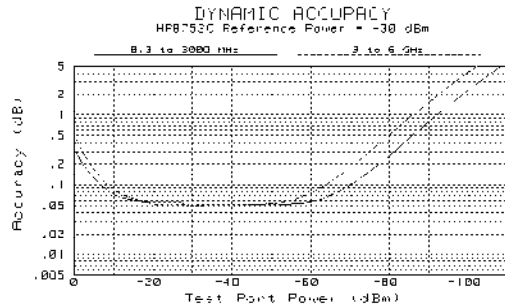

- Display resolution:** 0.001 dB/division
- Marker resolution<sup>1</sup>:** 0.001 dB
- Trace noise:** 300 kHz to 3 GHz: < 0.006 dB rms  
3 GHz to 6 GHz (Option 006): < 0.010 dB rms
- Reference level:**
  - Range:** ± 500 dB
  - Resolution:** 0.001 dB
- Stability:** 0.02 dB/°C, 300 kHz to 3 GHz (typical)  
0.04 dB/°C, 3 GHz to 6 GHz (typical)

## Phase Characteristics

Range: ±180 degrees

### Dynamic Accuracy

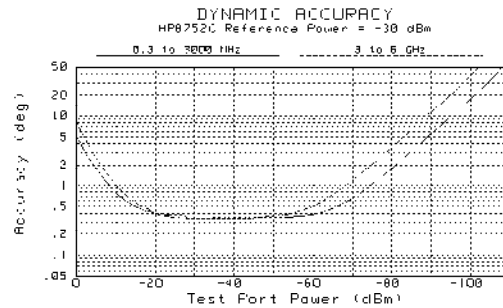

- Display resolution:** 0.01°/ division
- Marker resolution<sup>1</sup>:** 0.01°
- Trace noise:** 300 kHz to 3 GHz: < 0.038° rms  
3 GHz to 6 GHz (Option 006): < 0.070° rms
- Reference level:**
  - Range:** ± 500°
  - Resolution:** 0.001°
- Stability:** 0.05° /°C, 300 kHz to 3 GHz (typical)  
0.20° /°C, 3 GHz to 6 GHz (typical)

# HP 8752C and HP 8753D

## Supplemental Characteristics

### Measurement

**Number of display channels:**  
Two display channels available

**Measurement parameters:**  
HP 8752C: Transmission, reflection  
HP 8753D: S11, S21, S12, S22, A, B, R, A/R, B/R, A/B.  
Conversion to impedance or admittance

**Formats:**  
**Cartesian:** log/linear magnitude, phase, group delay, SWR, real and imaginary.  
**Smith chart:** with log/linear amplitude and phase,  $R + jX$ ,  $G + jB$ , or real/imaginary markers.  
**Polar:** with linear/log amplitude, phase, or real and imaginary markers.

**Data markers:**  
Each display channel has four independent markers which can be displayed simultaneously. Markers can indicate data at actual data points or they can interpolate between data points to allow the setting of a marker at an exact frequency. Any one of the four markers can be the reference marker for delta marker operation. Markers can be coupled or uncoupled between display channels. Eight independent markers can be displayed simultaneously on a single measurement in dual channel mode when markers are uncoupled.

**Marker functions:**  
Markers can be used in various functions: Marker search (Mkr to max, Mkr to min, Mkr to target), Mkr bandwidth with user-defined target values, mkr → start, mkr → stop, mkr → center, mkr → span, mkr → reference, mkr → delay, and trace statistics (average value, standard deviation, and peak-to-peak deviation of the data trace between two markers). The tracking function enables continuous update of marker search values on each sweep.

### Group Delay Characteristics

Group delay is computed by measuring the phase change within a specified frequency step (determined by the frequency span, and the number of points per sweep).

**Aperture:** selectable  
maximum aperture: 20% of frequency span  
minimum aperture: (freq. span) / (number of points - 1)

**Range:**  
The maximum delay is limited to measuring no more than 180° of phase change within the minimum aperture.  
Range =  $1 / (2 \times \text{minimum aperture})$

**Accuracy:**  
The following graph shows group delay accuracy at 1.3 GHz with Type-N full two-port calibration and 10 Hz IF bandwidth. Insertion loss is assumed to be < 2 dB and electrical length to be ten meters.

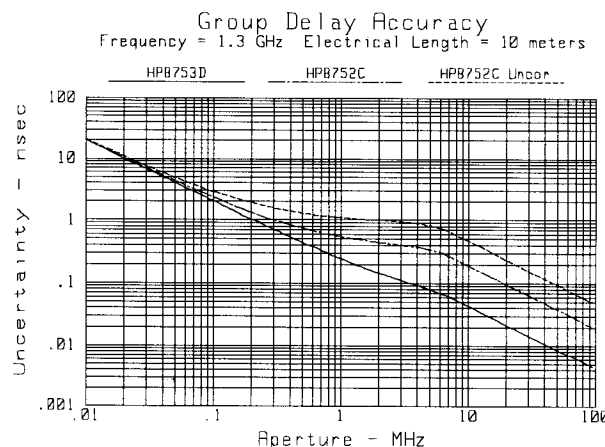

Group Delay Accuracy vs. Aperture

In general, the following formula can be used to determine the accuracy, in seconds, of a specific group delay measurement.

$$\pm(0.003 \times \text{Phase accuracy(deg)}) / \text{Aperture(Hz)}$$

Depending on the aperture and device length, the phase accuracy used is either incremental phase accuracy or worse case phase accuracy. The above graph shows this transition.

# HP 8752C and HP 8753D

## Supplemental Characteristics

---

### Source Control

**Sweep limits:**

Set start/stop or center/span of the stimulus parameter (frequency, power, time) directly through the source control keys and the control knob, the step keys or the data entry keyboard.

**Sweep type:**

Set a linear or logarithmic sweep, an arbitrarily defined frequency list, a power sweep or a CW (single frequency) type of sweep.

**Measured number of points per sweep:**

Linear frequency: choose 3, 11, 26, 51, 101, 201, 401, 801, or 1601 points.

**Arbitrary frequency list:**

Define up to 30 different sub-sweep frequency ranges in any combination of CW, CW-Delta F, or Start-Stop sweep modes.

**Sweep modes:**

Set a coupled channel sweep (same stimulus conditions on both channels) or an uncoupled channel sweep (alternate sweep).

**Chop/alternate:**

Select whether to alternately or simultaneously (chop) measure channels when in dual channel mode. Chop mode is faster, while alternate mode optimizes dynamic range. The analyzers default to chop mode.

**Sweep time:**

Set sweep time in seconds, minutes or hours. Minimum sweep time is dependent on number of data points per sweep and selected IF bandwidth.

**Auto sweep time:**

Select auto sweep time by entering zero seconds sweep time. The analyzer will sweep at the minimum sweep time for any subsequently selected stimulus conditions. Auto sweep time is the default condition.

**Sweep trigger:**

Set to either continuous, hold, single, group sweep, or external trigger. Set external trigger to take a complete sweep or to measure individual points in a frequency, power or list sweep.

**Power:**

Set source power (-85 to +10 dBm) for HP 8753D or HP 8752C (Option 004). Power slope can be set in dBm/GHz. With the HP 8753D control the test port signal by setting the internal attenuator of the test set over a 70 dB range. Power trip automatically reduces source power to its minimum value when excessive signal levels are incident on the receiver test port. A caution message is also displayed. (Source power range differs depending on the selected options. Refer to the "Test Port Output Characteristics" section for the appropriate instrument for more information.)

### Power Meter Calibration (HP 8753D)

**Description:**

Use a power meter to set leveled input or output power at the device-under-test at a single point or an entire sweep. With an HP 436A, HP 437B or HP 438A power meter connected, the Cal Sweep measures the actual test port power. After the calibration is enabled, the internal RF source power is adjusted (within the range of -85 to +10 dBm) to achieve the selected power at the input of the device under test rather than at the test port output. HP-IB control of the power meter for normalization or leveling is built-in. Logarithmic, linear, CW, and list sweeps can be calibrated.

**Update calibration:**

Select continuous leveling (requires a power splitter) by measuring and updating source power on each sweep or use a correction table (to modify source power) which is created with an initial single sweep.

**Number of readings:**

Make single or multiple power meter readings at each frequency.

### Data Accuracy Enhancement

**Measurement calibration:**

Measurement calibration is the process through which measurement uncertainty due to errors caused by system directivity, source and load match, tracking, and crosstalk are significantly reduced. In the HP 8752C, the systematic errors have been reduced by a built-in "factory calibration" so that the measurements can be made on many devices without performing a measurement calibration. For greater accuracy, especially for special test set-ups, the HP 8752C offers a one-port reflection calibration to remove the reflection systematic errors and a transmission response calibration to remove the tracking error. A wide range of calibrations are available for the HP 8753D. Full two-port calibration removes all the systematic errors to obtain the most accurate measurements.

**Calibration types available:****Frequency response:**

Simultaneous magnitude and phase correction of frequency response errors for either reflection or transmission measurements. Requires a short or open circuit termination (reflection) or a through connection (transmission).

**Response and isolation:**

Compensates for frequency response and directivity (reflection) or frequency response and crosstalk errors. Requires an open, short, and load circuit termination (reflection) and a through connection and load termination (transmission).

**One-port calibration:**

Uses test set port 1 or port 2 (HP 8753D) or reflection port (HP 8752C) to correct for directivity, frequency response and source match errors. Requires open, short, and load.

## HP 8752C and HP 8753D Supplemental Characteristics

---

### **Two-port calibration (HP 8753D):**

Compensates for directivity, source match, reflection frequency response, load match, transmission frequency response and crosstalk for an S-parameter test set. Crosstalk calibration can be eliminated. Requires open, short, and load terminations for both ports plus a through connection.

### **TRL\*/LRM\* calibration (HP 8753D):**

Compensates for directivity, reflection and transmission frequency response, and crosstalk in both the forward and reverse directions. Especially suitable for calibrating non-coaxial environments, such as in test fixtures. Requires through, reflect, and line or match standards. TRL\*/LRM\* is a special implementation of TRL/LRM calibration, modified for the three-sampler receiver in the HP 8753D.

### **One-port, two-path calibration (HP 8753D):**

A two-port cal for the one-port reflection/transmission test sets. Provides a full two-port error corrected measurement when the device under test is turned around and measured in both directions.

### **Interpolated error correction:**

With any type of accuracy enhancement applied, interpolated mode recalculates the error coefficients when the test frequencies are changed. The number of points can be increased or decreased and the start/stop frequencies can be changed, but the resulting frequency span must be equal to or less than the original calibration frequency span. System performance is not specified for measurements with interpolated error correction applied.

### **Set $Z_0$ :**

Can redefine the characteristic impedance of a measurement to a value other than 50 or 75 ohms.

### **Velocity factor:**

Enters the velocity factor to calculate equivalent electrical length.

### **Reference plane extension:**

Redefine the plane of measurement reference to other than port 1 or port 2 of the HP 8753D or the reflection and transmission ports of the HP 8752C. A new reference plane is defined in seconds of delay from the test set port and ranges between  $\pm 1$  seconds.

### **Select default calibration kit:**

Select from a list of standard calibration kits: 7 mm, 3.5 mm (choose HP 85033C or 85033D), Type-N 50 ohm, and Type-N 75 ohm. You can also define the standards (e.g., open circuit capacitance coefficients, offset short length, or fixed loads) of a user-defined kit.

### **Data averaging:**

#### **IF bandwidth:**

The IF bandwidth is selectable from 3 kHz to 10 Hz bandwidth to reduce the effective displayed noise floor of the instrument.

#### **Weighted sweep-to-sweep averaging:**

Averages vector data on each successive sweep.

$A(n) = S(n)/F + (1-1/F)*A(N-1)$  where  $A(n)$  is the current average,  $S(n)$  is the current input signal and  $F$  is the averaging factor. Averaging factors range from 1 to 999.

### **Trace smoothing:**

Similar to video filtering, this function computes the moving average of adjacent data points. Advantageous in reducing relatively small peak-to-peak noise values on large broadband measured data. Smoothing aperture defines the trace width (number of points) to be averaged, and ranges from 0.25% to 20% of the trace width. This function also sets the aperture for group delay measurements.

## Display Control

### **CRT formats:**

Single channel, dual channel overlay (both traces on one graticule), dual channel split (each trace on separate graticules).

### **Trace functions:**

**Display data:** Display current measurement data, memory data, or current measurement with measurement and memory data simultaneously.

**Trace math:** Vector division or subtraction of current linear measurement values and memory data.

### **Display annotations:**

Start/stop, center/span, or CW frequency, source level, scale/div, reference level, marker data, soft key functions, warning and caution messages, trace identification, and pass/fail indication.

### **Reference position:**

Ranges from the 0 (bottom) to 10 (top) graticule position.

### **Autoscale:**

Automatically selects scale resolution and reference value to center the trace on the CRT graticules for easy viewing.

### **Electrical delay:**

Offset measured phase or group delay by a defined amount of electrical delay, in seconds. Operates similarly to an electronic line stretcher. Amount of electrical delay can range between  $\pm 1$  seconds.

### **Frequency blanking:**

Blank out all frequency information on the display. Requires an instrument preset to re-enable frequency information on the display.

### **Title:**

Add custom titles (49 characters maximum) to the display of the HP 8752C or 8753D. Titles will be plotted when making hardcopies of displayed measurements. Titles can also be used to display operator messages or prompts for a manual adjustment during a test sequence.

# HP 8752C and HP 8753D

## Supplemental Characteristics

---

### **Adjust display:**

Control the intensity and background intensity values of the display. Also, customize the color, value, and brightness of the data traces, memory traces, reference lines, graticules, text, and warning messages. Default colors can be recalled along with one set of user-defined display values. Control is in % of full range.

### **Storage**

#### **Instrument state:**

Up to 31 instrument states can be stored internally or recalled via the SAVE/RECALL menu. Instrument states include all control settings, active limit lines, active list frequency tables, memory trace data, active calibration coefficients, and custom display titles. Storage is in non-volatile memory.

#### **Test sequences:**

Six measurement sequences can be stored or recalled via the sequencing menu. Sequences may also be recalled from Preset menu. Sequence register 6 is part of non-volatile storage and is not erased during a power cycle. If sequence 6 is titled AUTO, it will be executed when power is turned on.

#### **Disk drive:**

Data, instrument states (including calibration data), user graphics, data plots (HP-GL commands), and test sequences can also be stored on disk, using the HP 8753D's built-in disk drive or an external disk drive with command subset CS/80. Data files can be stored in MS-DOS format or Hewlett-Packard's standard LIF format, which can be read by a wide variety of computers, including the HP 9000 series 300 and 400. Files can be stored in binary or ASCII formats (compatible with the HP 85150A microwave design system). A disk to be used for data storage can be initialized directly by the HP 8753D.

#### **Compatible disk drives:**

HP 9122C Dual 3.5 inch disk drive  
HP 9153C Winchester disk drive

### **Data Hardcopy**

#### **Data plotting:**

Hard copy plots are automatically produced with HP-GL compatible digital plotters such as the HP 7475A and compatible graphics printers such as the HP DeskJet or LaserJet (in single color or multi-color format). The HP 8753D provides Centronics, RS-232C, and HP-IB interfaces. The HP 8752C has an HP-IB interface, and requires an HP-IB to Centronics converter to connect to Centronics peripherals.

#### **Data listings:**

Printouts of instrument data are directly produced with a printer such as the HP DeskJet 520 or 560C or PaintJet 3630A. Select a standard (single color) or color print (with color printers).

#### **Configure plots:**

Configure plots completely from the network analyzer by defining pen color and line type for data, text markers, graticules, and memory traces.

#### **Functions:**

Plot trace(s), graticule(s), markers(s), or text including operating and system parameters.

#### **Quadrants:**

Plot entire display in one of four different quadrants of the plotter paper.

### **System Capabilities**

#### **Limit lines:**

Define test limit lines that appear on the display for go/no go testing. Lines may be any combination of horizontal, sloping lines, or discrete data points. Limit test TTL output available for external control or indication.

#### **Operating parameters:**

Display, print or plot current instrument operating parameters.

#### **Transform:**

When time domain (Option 010) is present, selects the Time Domain transform menu.

#### **Harmonic measurements (HP 8753D):**

When harmonic measurement (Option 002) is present, selects the 2nd or 3rd harmonic measurement menu.

#### **Instrument mode:**

Select external source, tuned receiver or frequency offset mode.

#### **External source mode:**

The receiver (input R) detects and phase-locks to any externally generated CW signal. Receiver inputs A and B will measure this same frequency for comparison or tracking measurements.

**Auto:** The input signal frequency is counted and displayed.

**Manual:** Measures the input signal closest to the frequency specified by the user (within -0.5 to +5 MHz).

#### **Tuned receiver:**

Tunes the receiver for a synthesized CW input signal at a precisely specified frequency. The time bases of the external RF source or sources must be tied to the external reference input (rear panel BNC). The built-in RF source is not used.

#### **Frequency offset on/off:**

Sets the RF source to be swept at a fixed offset frequency above the receiver as required in a swept RF/IF, fixed LO, mixer test. The maximum delay between the RF source and the R channel input is 0.3 microseconds. Frequency offset mode has a 6 GHz maximum source limitation.

# HP 8752C and HP 8753D

## Supplemental Characteristics

---

**Offset value:**

Set the offset frequency value.

**Service menu:**

Select the desired service test, service diagnostic, service or verification mode.

### Test Sequences

**Description:**

Create, edit, save or recall a series of front-panel keystrokes to automate a measurement. Each of the six sequence registers can hold approximately 200 instructions. Create or edit a sequence by selecting the sequence menu and then simply performing the front-panel keystrokes that would normally be used to make a manual measurement. Test sequences may contain basic stimulus and measurement functions (frequency, power, parameter, format, scale) advanced operations (time domain, limit testing, display marker values) and basic logical branching (IF limit test fails DO sequence 5). Completed sequences are then saved and can be executed when you are ready to repeat the test.

**Storage:**

Test sequences can be stored internally to a disk drive and can be loaded from a computer over the HP-IB interface. Sequence 6 is saved in non-volatile storage and can be used as an autostart routine when titled AUTO.

**Branching:**

Branch to another sequence on limit test pass/fail, or the loop counter value. Subroutines are also possible via GOSUB.

**Other HP-IB instruments:**

Send simple commands to HP-IB instruments via the title string.

**Test sequence BNC output (HP 8753D):**

Set TTL high or low on the HP 8753D's test set rear panel output.

**General purpose input/output:**

Read or write bits to the output port to control external devices such as part handlers. Eight output and five input TTL lines are available on the parallel port of the HP 8753D. One input and four output TTL lines are available from the test set interconnect on the HP 8752C.

**Other functions:**

Pause/continue, wait, title sequence, print sequence, duplicate sequence, pause and select.

### Time Domain (Option 010)

**Description:**

With the time domain option, data from transmission or reflection measurements in the frequency domain is converted to the time domain using a Fourier transformation technique (Chirp Z) and presented on the display. The time domain response shows the measured parameter value versus time. Markers may also be displayed in electrical length (or physical length if the relative propagation velocity is entered).

Footnotes are at the end of this document.

**Time stimulus modes****Standard stimulus:**

Two types of time excitation stimulus waveforms can be simulated during the transformation -- a step and an impulse.

**External stimulus:**

The definition of other time excitation stimulus waveforms can be accomplished using an external controller.

**Low pass step:**

This stimulus, similar to a traditional time domain reflectometer (TDR) stimulus waveform, is used to measure low pass devices. The frequency domain data should extend from DC (extrapolated value) to a higher value, the upper limit being defined by the test set used. The time domain response shows the parameter value versus time (multiply by the speed of light, c, to obtain electrical length or by c and Vrel to obtain physical length). The step response is typically used for reflection measurements only.

**Low pass impulse:**

This stimulus is also used to measure low pass devices. The frequency domain data should extend from DC (extrapolated value) to a higher value, the maximum frequency determined by the test set. The time domain response shows changes in the parameter value versus time. The impulse response can be used for reflection or transmission measurements.

**Bandpass impulse:**

The bandpass impulse stimulates a pulsed RF signal (with an impulse envelope) and is used to measure the time domain response of band-limited devices. The start and stop frequencies are selectable by the user to any values within the limits of the test set used. The bandpass time domain response also shows changes in the parameter values versus time. Bandpass time domain responses are useful for both reflection and transmission measurements.

**Time domain range:**

The range over which the display is free of response repetition depends on the frequency span and the number of points.

Range, in nanoseconds, is determined by:

$$Range = 1/\Delta F = \frac{(\text{Number of points in Frequency Domain} - 1)}{\text{Frequency Span (GHz)}}$$

**Range resolution:**

Range-resolution is how closely in time that a response can be located.

$$\text{Range-resolution} = \text{time span}/(\text{number of points} - 1)$$

**Windows:**

The windowing function can be used to modify (filter) the frequency domain data and thereby reduce overshoot and ringing in the time domain response. Three types of windows are available -- minimum, normal, and maximum.

# HP 8752C and HP 8753D

## Supplemental Characteristics

### Gating:

The gating function can be used to selectively remove reflection or transmission time domain responses. In converting back to the frequency domain the effects of the responses outside the gate are removed. The location and span of the gate can be controlled by setting either the center position and time span of the gate or by setting the start and stop time of the gate.

### HP 8752C Options

#### 3 GHz operation (Option 003)

#### 6 GHz operation (Option 006)

##### Description:

These options extend the specified performance of the HP 8752C over the 300 kHz to 3 GHz (Option 003) or 6 GHz (Option 006) range.

#### Step attenuator (Option 004)

##### Description:

This option adds a built-in 70 dB step attenuator, extending the source output power range to -85 to +10 dBm.

### HP 8753D Options

#### Harmonic measurements (Option 002)

##### Description:

Measures amplifier 2nd and 3rd harmonics on a swept-frequency basis for fundamental signals above 16 MHz. Harmonics are measured up to the maximum frequency range of the receiver. The second harmonic of 1.5 GHz fundamental and 3rd harmonic of a 1 GHz fundamental can be measured and displayed. If option 006 is installed, the 2nd harmonic of a 3 GHz fundamental and 3rd harmonic of a 2 GHz fundamental can be measured.

**Dynamic range** (source at -10 dBm, receiver <-30 dBm):  
-40 dBc (minimum)

**Accuracy:**<sup>14</sup> ±1 dB (< 6 GHz)

#### 6 GHz operation (Option 006)

##### Description:

With the 6 GHz option, performance is specified over the 30 kHz to 6 GHz range. When external source, tuned receiver or harmonic mode is used, the receiver is capable of measuring signals up to 6 GHz.

#### High Stability Frequency Reference (Option 1D5)

##### Description:

This option adds an ovenized 10 MHz frequency reference output to the HP 8753D. It is connected to the external reference input on the rear panel. See the "General Characteristics" section for specifications.

### Measurement Throughput Summary

The following table shows typical measurement times in milliseconds.

*Typical time for completion (msec)*

Measurement	Number of Points			
	51	201	401	1,601
Uncorrected, 1-port cal <sup>15</sup>	125	200	300	900
Two-port cal <sup>16</sup>	245	510	855	2,940
Time domain conversion <sup>17</sup>	80	350	740	1,790
HP-IB data transfer <sup>18</sup>				
Internal binary	20	35	55	205
ASCII	140	510	1,000	3,960
IEEE 754 floating point format:				
32-bit	25	85	150	590
64-bit	40	115	220	840

### Remote Programming

#### Interface:

HP-IB interface operates to IEEE 488-1978 and IEC 625 standards and IEEE 728-1982 recommended practices.

#### Addressing:

The HP-IB address of the HP 8753D can be verified or set from the front panel via the local menu and can range from 0 to 30 decimal (factory set at 16).

#### Pass control:

Allows the HP 8753D to request control of the HP-IB (when an active controller is present) whenever it needs to output to a plotter or printer.

#### System controller:

Lets an HP 8753D become a controller on the HP-IB to directly control a plotter or a printer.

#### Talker/listener:

Lets the HP 8753D become an HP-IB talker/listener when an external controller is present.

#### Transfer formats:

Binary (internal 48-bit floating point complex format)  
ASCII  
32- or 64- bit IEEE 754 floating point format

#### User-accessible graphics:

Using a subset of HP graphics language (HP-GL), vector or text graphics may be written on the HP 8753D via HP-IB. Up to 5 kbytes of data can be stored at one time (4 bytes per vector, 2 bytes per character).

# HP 8752C and HP 8753D

## Supplemental Characteristics

---

### Interface function codes:

SH1, AH1, T6, TE0, L4, LE0, SR1, RL1, PP0, DC1, DT0, C1, C2, C3, C10, E2

## General Characteristics

### Front Panel Connectors

#### HP 8753D test ports (without Option 011):

Connector type	7 mm precision
Impedance	50 ohms (nominal)
Connector conductor depth	0.000 to 0.003 in.

#### HP 8752C and HP 8753D Option 011 test ports:

Connector type	Type-N
Impedance	50 ohms (nominal)
Connector center pin protrusion	0.204 to 0.207 in.

#### Option 075 test ports (HP 8752C or HP 8753D):

Connector type	Type-N
Impedance	75 ohms (nominal)
Connector center pin protrusion	0.204 to 0.207 in.

Probe power	+ 15V $\pm$ 2% 400 mA (combined load for both probe connections) -12.6V $\pm$ 5.5% 300 mA (combined load for both probe connections)
-------------	---

### Rear Panel Connectors

#### External reference frequency input (EXT REF INPUT)

Frequency	1, 2, 5, and 10 MHz ( $\pm$ 200 Hz at 10 MHz)
Level	-10 dBm to +20 dBm, typical
Impedance	50 ohms

#### High-stability frequency reference output (HP 8753D Option 1D5)

Frequency	10.0000 MHz
Frequency Stability (0°C to 55°C)	$\pm$ 0.05 ppm
Daily Aging Rate (after 30 days)	$<3 \times 10^{-9}$ /day
Yearly Aging Rate	0.5 ppm/year
Output	0 dBm minimum
Nominal Output Impedance	50 $\Omega$

#### External auxiliary input (AUX INPUT)

Input Voltage Limits	-10V to +10V
----------------------	--------------

External AM input (EXT AM)	$\pm$ 1 volt into a 5 k $\Omega$ resistor, 1 kHz maximum, resulting in 8 dB/volt amplitude modulation.
----------------------------	--

External trigger (EXT TRIGGER)	Triggers on a negative TTL transition or contact closure to ground.
--------------------------------	---

### Test sequence output (TEST SEQ; HP 8753D only)

By default, this connector outputs a TTL end-of-sweep signal. It can also be programmed by the user in a test sequence to output a user-defined TTL signal.

### Limit test output (LIMIT TEST; HP 8753D only)

This connector outputs a TTL signal of the limit test results. Pass: TTL high. Fail: TTL low.

### Test port bias input (BIAS CONNECT; HP 8753D only)

Maximum voltage	+30 VDC
Maximum Current (no degradation in RF specs)	$\pm$ 200 mA
Maximum current	$\pm$ 1 A

### Video output (EXT MON)

The R, G, and B connectors drive external monitors with these characteristics:

R, G, B with synch on green.  
75 ohm impedance.  
1Vp-p (0.7V = white; 0V = black; -0.3V = synch).

### HP-IB

This connector allows communications with compatible devices including external controllers, printers, plotters, disk drives, and power meters.

### Parallel port (HP 8753D only)

This 25-pin female connector is used with parallel (or Centronics interface) peripherals such as printers and plotters. It can also be used as a general purpose I/O port, with control provided by test sequencing functions.

### RS-232C (HP 8753D only)

This 9-pin male connector is used with serial peripherals such as printers and plotters.

### DIN keyboard (HP 8753D only)

This connector is used for adding an IBM PC-AT compatible keyboard for titles and remote front-panel operation.

### Test set interconnect

This connector is used to connect an HP 8753D Option 011 to the HP 85046A/B or 85047A test set. On other HP 8753D or HP 8752C analyzers, you can use signal levels on this connector for sequencing or general purpose I/O applications with an adapter, such as HP part number 08752-60020 (for use with the HP 8752C).

### Internal Memory

Typical data retention time with 3V, 1.2 Ah battery:

At 25°C	11904 days (32.6 years)
At 40°C	1244 days (3.4 years)
At 70°C	250 days (0.68 year)

### Line power

48 Hz to 66 Hz  
115V nominal (90V to 132V) or 230V nominal (198V to 264V).  
280 VA max.



# HP 8752C and HP 8753D Supplemental Characteristics

## Environmental Characteristics

### General conditions

RFI and EMI susceptibility: defined by VDE 0730, CISPR Publication 11, and FCC Class B Standards.

ESD (electrostatic discharge): must be eliminated by use of static-safe work procedures and an anti-static bench mat (such as an HP 92175T).

The flexible rubber keypad protects key contacts from dust, but the environment should be as dust-free as possible for optimal reliability.

### Operating conditions

<b>Temperature (unless otherwise noted)</b>	0° to 55°C
<b>Humidity</b>	5% to 95% at 40°C (non-condensing)
<b>Altitude</b>	0 to 4500 meters (15,000 feet)

### Non-Operating Storage Conditions

<b>Temperature</b>	-40°C to +70°C
<b>Humidity</b>	0 to 90% relative at +65°C (non-condensing)
<b>Altitude</b>	0 to 15,240 meters (50,000 feet)

### Weight: HP 8753D

<b>Net</b>	34 kg (75 lb)
<b>Shipping</b>	37 kg (82 lb)

### Weight: HP 8752C

<b>Net</b>	25.4 kg (56 lb)
<b>Shipping</b>	28.4 kg (63 lb)

## Cabinet dimensions

(These dimensions exclude front and rear panel protrusions.)

### HP 8753D:

222 mm H x 425 mm W x 508 mm D  
(8.75 in x 16.75 in x 20.0 in)

### HP 8752C:

178 mm H x 425 mm W x 508 mm D  
(7.0 in x 16.75 in x 20.0 in)

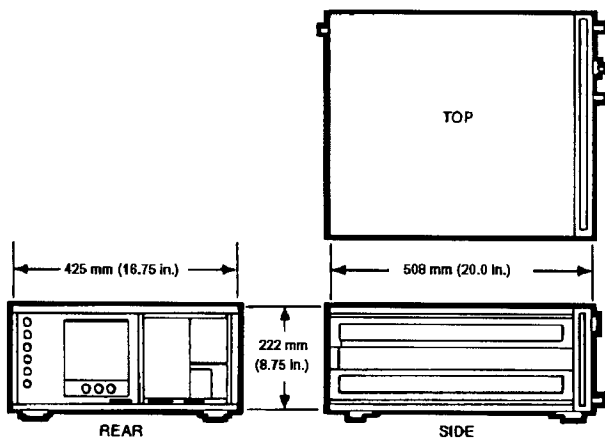

HP 8753D physical dimensions

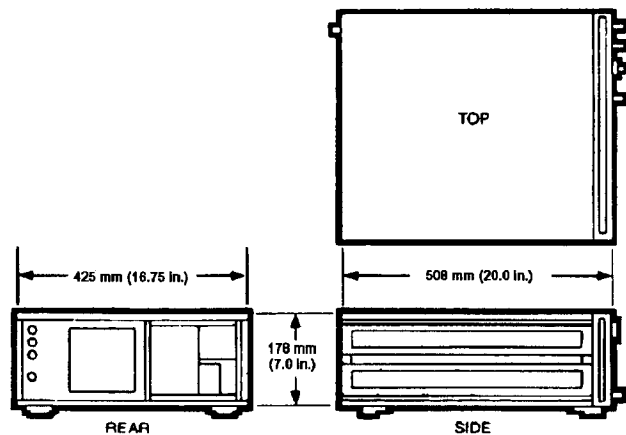

HP 8752C physical dimensions

# HP 8753D

## Test Set Specifications

### HP 85044A/B Transmission/Reflection Test Sets

The HP 85044A/B Transmission/Reflection Test Sets provide the capability to simultaneously measure the reflection and transmission characteristics of 50 and 75 ohm devices, when used with the HP 8753D option 011. Two port devices must be physically turned around to measure their reverse direction characteristics. The frequency range of the HP 85044A 50 ohm test set is 300 kHz to 3 GHz. The HP 85044A has a precision 7 mm test port connector. The frequency range of the HP 85044B 75 ohm test set is 300 kHz to 2 GHz. The HP 85044B has a 75 ohm type N(f) test port connector.

#### Specifications **HP 85044A(B)**

**Impedance:** 50 ohm (75 ohm)  
**Frequency range:** 300 kHz to 3 GHz  
 (300 kHz to 2 GHz)  
**Directivity:** 35 dB to 1.3 GHz  
 30 dB to  $F_{max}$ <sup>19</sup>

#### Typical tracking:

**Transmission magnitude, phase:**<sup>20</sup>  
 0.3 MHz to 2.0 MHz  $\pm 1.5$  dB,  $\pm 10^\circ$   
 2.0 MHz to  $F_{max}$   $\pm 1.5$  dB,  $\pm 10^\circ$   
**Reflection magnitude, phase:**<sup>20</sup>  
 0.3 MHz to 2.0 MHz  $\pm 1.5$  dB,  $\pm 25^\circ$   
 2.0 MHz to  $F_{max}$   $\pm 1.5$  dB,  $\pm 10^\circ$   
**Effective source match:**  
 0.3 MHz to 2.0 MHz 14 dB  
 2.0 MHz to 1.3 GHz 20 dB (17 dB)  
 1.3 GHz to  $F_{max}$  16 dB

#### Nominal insertion loss:

**Input to test port:** 12.5 dB + 0.5 dB/GHz  
 (18 dB + 0.5 dB/GHz)  
**Input to incident:** 18 dB + 1.5 dB/GHz  
 (18 dB + 1 dB/GHz)  
**Port 1, 2 to A, B:** 6.5 dB + 1.0 dB/GHz  
 (12 dB + 1 dB/GHz)

#### Test set switch/repeatability:<sup>21</sup>

N/A  
**Max operating level:** +20 dBm  
**Damage level:** +30 dBm (1 watt)  
**RF attenuator range:** 70 dB (10 dB steps)  
**DC bias range:**  $\pm 30$  VDC, 200 mA (some degradation of RF specs); 500 mA max  
**DC bias connectors:** 50 ohm BNC (f)  
**Includes:** HP 85044A: 7 mm to 50 ohm Type-N (f) adapter;  
 HP 85044B: one HP 11852B minimum loss pad.  
**Dimensions:** 62 mm H x 191 mm W x 204 mm D  
**Weight:** net 1.7 kg (3.8 lb)

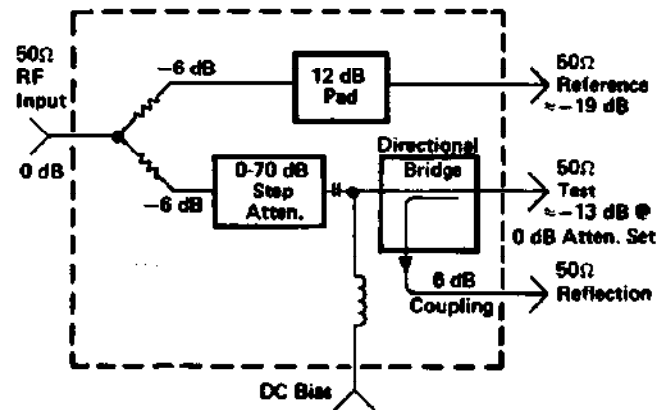

HP 85044A Schematic

# HP 8753D Test Set Specifications

## HP 85046A/B S-parameter Test Sets

The HP 85046A/B S-parameter test sets provide the capability to measure reflection and transmission characteristics (including S-parameters) of two-port devices in either direction with a single connection. The test sets are controlled from the HP 8753D Option 011 and include a programmable step attenuator. The frequency range of the HP 85046A 50 ohm test set is 300 kHz to 3 GHz. The HP 85046A has precision 7 mm connectors. The frequency range of the HP 85046B 75 ohm test set is 300 kHz to 2 GHz. The HP 85046B has 75 ohm type N(f) connectors. Both connectors can be adapted to other interfaces with the appropriate precision adapters.

A standard HP 85046A/B test set contains a solid-state transfer switch, which allows continuous switching of power from port 1 to port 2 for full two-port error correction. Option 009 replaces the transfer switch with a mechanical switch. This provides about 1.5 dB more power at the test port, but does not allow continuous switching, so the user must initiate updates of all four s-parameters for full two-port error correction. Also, the mechanical switch has relays that will wear out faster than the solid-state switch. Approximate lifetime of the mechanical switch is 1 million cycles.

<b>Specifications</b>	<b>HP 85046A(B)</b>
<b>Impedance:</b>	50 ohm (75 ohm)
<b>Frequency range:</b>	300 kHz to 3 GHz (300 kHz to 2 GHz)
<b>Directivity:</b>	35 dB to 1.3 GHz 30 dB to $F_{max}$ <sup>19</sup>
<b>Typical tracking:</b>	
<b>Transmission magnitude, phase:</b> <sup>20</sup>	
0.3 MHz to 2.0 MHz	$\pm 1.5$ dB, $\pm 20^\circ$
2.0 MHz to $F_{max}$	$\pm 1.5$ dB, $\pm 10^\circ$
<b>Reflection magnitude, phase:</b> <sup>20</sup>	
0.3 MHz to 2.0 MHz	$\pm 1.5$ dB, $\pm 25^\circ$
2.0 MHz to $F_{max}$	$\pm 1.5$ dB, $\pm 10^\circ$
<b>Effective source match:</b>	
0.3 MHz to 2.0 MHz	14 dB
2.0 MHz to 1.3 GHz	20 dB (17 dB)
1.3 GHz to $F_{max}$	16 dB
<b>Nominal insertion loss:</b>	
<b>Input to test port:</b>	14 dB + 0.5 dB/GHz (19.5 dB + 1 dB/GHz)
<b>Input to incident:</b>	18 dB + 1.5 dB/GHz (18 dB + 1.5 dB/GHz)
<b>Port 1, 2 to A, B:</b>	6.5 dB + 1.0 dB/GHz (12 dB + 0.5 dB/GHz)
<b>Test set switch/repeatability:</b> <sup>21</sup>	$\pm 0.03$ dB
<b>Max. operating level:</b>	+ 20 dBm
<b>Damage level:</b>	+30 dBm
<b>RF attenuator range:</b>	70 dB (10 dB steps)
<b>DC bias range</b>	$\pm 30$ VDC, 200 mA (some degradation of RF specs); 500 mA max
<b>DC bias connectors:</b>	50 ohm BNC (f)
<b>Includes:</b>	four 190 mm (7.5 in) Type N cables and test set interconnect cable.
<b>Dimensions:</b>	90 mm H x 432 mm W x 553 mm D
<b>Weight:</b>	9.1 kg (20 lb)

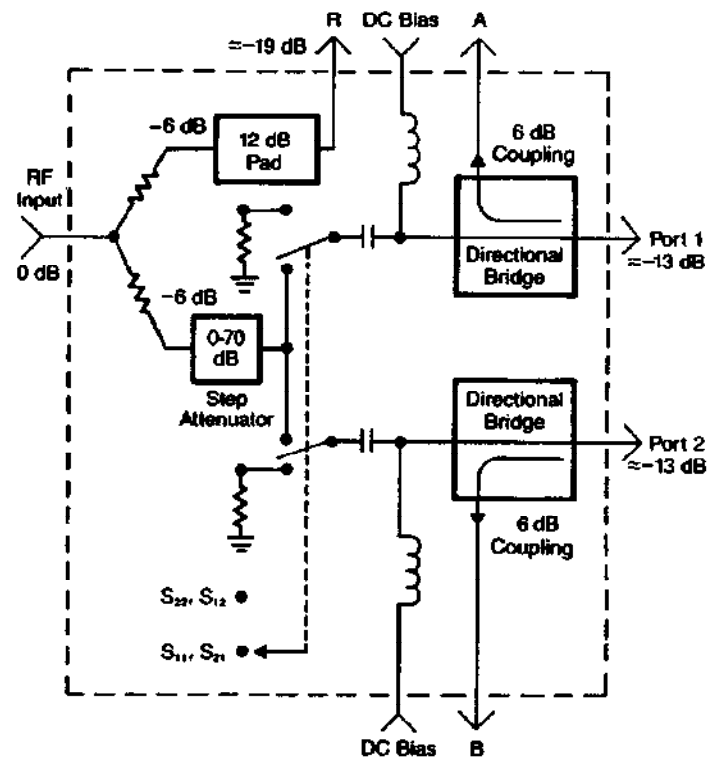

HP 85046A Schematic

# HP 8753D

## Test Set Specifications

### HP 85047A S-Parameter Test Set

The HP 85047A S-parameter test set provides the capability to simultaneously measure the reflection and transmission characteristics of two-port devices in either direction with a single connection. This test set includes a frequency doubler that can be switched in by an HP 8753B/C Option 006 to measure 3 MHz to 6 GHz in a single sweep or switched out to measure 300 kHz to 3 GHz in a single sweep. The HP 8753D Option 011 does not use the frequency doubler, so the full 300 kHz to 6 GHz range is available. This test set exhibits < 5 dB insertion loss between the RF input and the test ports as high as 15 dBm at the test port, and also includes a programmable step attenuator. There are two rear panel BNC outputs. One provides a TTL signal which indicates the result of a limit test. The second TTL output is controlled from the HP 8753D test sequence function.

A standard HP 85047A test set contains a solid-state transfer switch, which allows continuous switching of power from port 1 to port 2 for full two-port error correction. Option 009 replaces the transfer switch with a mechanical switch. This provides about 2.5 to 3.5 dB more power at the test port, but does not allow continuous switching, so the user must initiate updates of all four s-parameters for full two-port error correction. Also, the mechanical switch has relays that will wear out faster than the solid-state switch. Approximate lifetime of the mechanical switch is 1 million cycles.

#### Specifications

**HP 85047A**  
**Impedance:** 50 ohms  
**Frequency ranges:** 300 kHz to 3 GHz and 3 MHz to 6 GHz with HP 8753B/C; 300 kHz to 6 GHz (HP 8753D Opt. 006)

#### Directivity:<sup>22</sup>

300 kHz to 1.3 GHz 35 dB<sup>23</sup>  
 1.3 GHz to 3 GHz 30 dB  
 3 GHz to 6 GHz 25 dB

#### Typical tracking:<sup>22</sup>

**Transmission magnitude, phase:<sup>24</sup>**  
 300 kHz to 3 GHz ±1.5 dB, ±10°  
 3 GHz to 6 GHz +0.5, -2.5 dB, ±20°

**Reflection magnitude, phase:<sup>24</sup>**  
 300 kHz to 3 GHz ±1.5 dB, ±10°  
 3 GHz to 6 GHz ±1.5 dB, ±20°

#### Source match:<sup>22</sup>

300 kHz to 1.3 GHz 20 dB  
 1.3 GHz to 3 GHz 16 dB  
 3 GHz to 6 GHz 14 dB

#### Normal insertion loss:

**Input to port 1,2** 4.0 dB +0.8 dB/GHz (3 GHz range)  
 17.5 dB +0.8 dB/GHz (6 GHz range)

**Input to R** 19 dB +0.5 dB/GHz (3 GHz range)  
 34 dB +0.5 dB/GHz (3 GHz range)

**Port 1,2 to A,B** 16 dB

#### Typical isolation:

100 dB (3 GHz range)

90 dB (6 GHz range)

#### Test port switch repeatability:<sup>21</sup>

±0.03 dB

#### Maximum operating level:

Damage level: +30 dBm

#### RF attenuator range:

70 dB (10 dB steps)

#### DC bias range:

±30 VDC, 200 mA, no degradation in RF specs, 1A max.

#### RF connectors:

Port 1,2: 7 mm precision

All others: 50 ohm type N(f)

Dimensions: 90 mm H x 432 mm W x 553 mm D

Weight: 10 kg (22 lb)

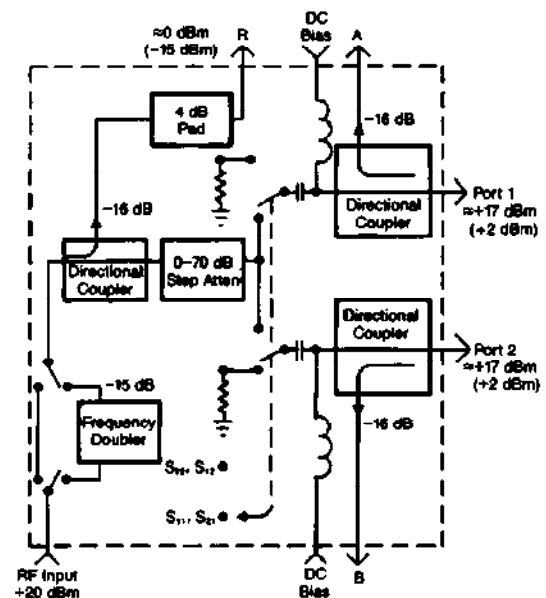

HP 85047A Schematic

# HP 8753D Accessories

## Calibration and Verification Kits

### Calibration Kits

Vector accuracy enhancement procedures require that the systematic errors of the measurement system be characterized by measuring known devices (standards) on the system over the frequency range of interest. The following calibration kits contain precision standards in many different connector types. Return loss specifications or typical values are provided where available for the terminations and adapters.

#### HP 85031B 7 mm Calibration Kit

Contains precision 7 mm standards used to calibrate the HP 8753D for measurement of devices with precision 7 mm connectors.

##### Includes:

7 mm short/open circuit	HP 00909-60008
7 mm 50 ohm term (two each)	HP 85031-60002
Specifications for terminations:	DC to 5 GHz: $RL \geq 52$ dB
	5 to 6 GHz: $RL \geq 46$ dB

#### HP 85032B 50 ohm Type-N Calibration Kit

Contains precision 50 ohm Type-N standards used to calibrate the HP 8753D and 50 ohm test sets for measurement of devices with 50 ohm Type-N connectors. Precision phase-matched 7 mm to Type-N adapters are included for accurate measurements of non-insertable devices.

##### Includes:

N-male 50 ohm termination	HP 00909-60009
N-female 50 ohm termination	HP 00909-60010
N-male short circuit	HP 85032-60008
N-female short circuit	HP 85032-60009
N-female open circuit	HP 85032-60012
N-male open circuit	HP 85032-60009
7 mm to N-male adapter (two each)	HP 85054-60009
7 mm to N-female adapter (two each)	HP 85054-60001
Specifications for terminations:	DC to 3 GHz: $RL \geq 49$ dB
	2 to 3 GHz: $RL \geq 46$ dB
	3 to 6 GHz: $RL \geq 40$ dB
Typical adapter characteristics:	DC to 6 GHz: $RL \geq 30$ dB

#### HP 85033D 3.5 mm Calibration Kit

Contains a set of precision 3.5 mm standards to calibrate the HP 8753D and 50 ohm test sets for the measurement of devices with precision 3.5 mm and SMA connectors. Precision phase-matched 7 mm to 3.5 mm adapters are included for accurate measurements of non-insertable devices.

##### Includes:

3.5 mm-male 50 ohm termination	HP 85033-60009
3.5 mm-female 50 ohm termination	HP 85033-60010
3.5 mm-female short	HP 85033-60014
3.5 mm-male short	HP 85033-60013
3.5 mm-female open	HP 85033-60012

3.5 mm-male open	HP 85033-60011
7 mm to 3.5 mm female adapter (two)	HP 1250-1747
7 mm to 3.5 mm male adapter (two)	HP 1250-1746
Specifications for terminations:	DC to 1.3 GHz: $RL \geq 46$ dB
	1.3 to 3 GHz: $RL \geq 44$ dB
	3 to 6 GHz: $RL \geq 38$ dB
Typical adapter characteristics	DC to 6 GHz: $RL \geq 34$ dB

#### HP 85036B 75 ohm Type-N Calibration Kit

Contains a set of precision 75 ohm Type-N standards to calibrate the HP 8753D and 75 ohm test sets for measurement of devices with 75 ohm Type-N connectors. Precision phased matched adapters are included for accurate measurements of non-insertable devices.

##### Includes:

N-male 75 ohm termination	HP 00929-60019
N-female 75 ohm termination	HP 00909-60085
N-female 75 ohm short	HP 85036-60011
N-male 75 ohm short	HP 85036-60012
N-female open	HP 85032-20001
N-male open	HP 85032-60007
N-male to N-male 75 ohm adapter	HP 85036-60013
N-female to N-female 75 ohm adapter	HP 85036-60014
N-male to N-female 75 ohm adapter	HP 85036-60015
Specifications for terminations:	DC to 2 GHz: $RL \geq 46$ dB
	2 to 3 GHz: $RL \geq 40$ dB

#### HP 85039A Type-F Calibration Kit

Contains a set of 75 ohm type-F standards to calibrate the HP 8753D and 75 ohm test set for the measurement of devices with type-F connectors.

##### Includes:

F-male 75 ohm termination	HP 0955-0724
Specifications for termination:	DC to 1.3 GHz: $RL \geq 38$ dB
	1.3 to 3 GHz: $RL \geq 32$ dB
F-male 75 ohm short	HP 0955-0726
F-male open	HP 0955-0725
F-female to F-female 75 ohm adapter	HP 1250-2489
Typical type-F adapter characteristics:	DC to 1.3 GHz: $RL \geq 38$ dB
	1.3 to 3 GHz: $RL \geq 32$ dB
N-male to F-male 75 ohm adapter	HP 1250-2488
N-female to F-male 75 ohm adapter	HP 1250-2490
Typical type-N to type-F adapter characteristics:	DC to 1.3 GHz: $RL \geq 32$ dB
	1.3 to 3 GHz: $RL \geq 26$ dB

# HP 8753D Accessories

## Calibration and Verification Kits

### HP 85033A SMA Calibration Kit

Contains a set of typical standards to calibrate the HP 8753D and 50 ohm test sets when measuring devices with SMA connectors. These are not precision standards and should not be used as error correction standards. Those applications which require the highest levels of accuracy should utilize an HP 85033D 3.5 mm calibration kit.

#### Includes:

SMA-male 50 ohm termination.	HP 0960-0053
SMA-female 50 ohm termination.	HP 0960-0050
SMA-male short	HP 0960-0055
SMA-female short	HP 0960-0054
7 mm to SMA male adapters (two each)	HP 1250 1468
7 mm to SMA male adapters (two each)	HP 1250-1467
Typical termination characteristics:	DC to 1 GHz: RL $\geq$ 31 dB 1 to 4 GHz: RL $\geq$ 27 dB 4 to 10 GHz: RL $\geq$ 23 dB

### Verification Kits

Measuring known devices other than the standards used in calibration is an easy way to verify the proper operation of an HP 8753D measurement system. HP offers verification kits which include devices, with data, for verifying the error-corrected measurements of an HP 8753D and 50 ohm test sets.

#### HP 85029B 7 mm Verification Kit

Contains a set of precision 7 mm devices, with data traceable to NIST used to compare the calibrated performance of an HP 8753D measurement system. The HP 85031B 7 mm calibration kit is required for complete verification.

### Test Port Return Cables

Hewlett-Packard offers high quality RF cables used to connect the HP 8753D and test sets to devices under test. These cables offer excellent RF shielding for high dynamic range measurements.

#### HP 11851B 50 ohm Type-N RF Cable Kit

Contains the necessary 50 ohm Type-N cables to connect the HP 8753D Option 011 to the HP 85044A/B transmission/reflection test sets, including an RF cable to return the transmitted signal of a two port device to the HP 8753D. It is also recommended for use with the HP 11850C/D three way power splitters. Kit includes three phase matched 610 mm (24") cables and one 860 mm (34") cable.

Return loss: > 24 dB to 3 GHz

Phase tracking:  $\pm 4^\circ$  at 1.3 GHz

#### HP 11857B 75 ohm Type-N Test Port Return Cables

A pair of 610 mm (24") test port return cables for use with the HP 8753D or HP 85046B 75 ohm S-parameter test set.

Return loss: > 24 dB to 2 GHz

Phase tracking:  $\pm 2^\circ$  at 1.3 GHz

#### HP 11857D 7 mm Test Port Return Cables

A pair of 610 mm (24") test port return cables for use with the HP 8753D or HP 85046A, HP 85047A S-parameter test sets. These cables can be used with connector types other than 7 mm with the appropriate precision adapters.

Return loss: >24 dB to 3 GHz

>20 dB to 6 GHz

Phase tracking:  $\pm 2^\circ$  at 1.3 GHz

#### HP 11850C/D Three Way Power Splitters

	HP 11850C	HP 11850D
<b>Impedance:</b>	50 ohms	75 ohms
<b>Frequency range:</b>	DC to 3 GHz	DC to 2 GHz
<b>Tracking:</b>	$\pm 25$ dB, $\pm 3^\circ$	$\pm 2$ dB, $\pm 2.5^\circ$
<b>Equivalent source match:</b> (ratio or leveling)	30 dB at 1.3 GHz 20 dB at 3 GHz	30 dB at 1.3 GHz 20 dB at 2 GHz
<b>Nominal insertion loss:</b>	9.5 dB + 1dB/GHz	7.8 dB
<b>Input port match:</b>		
DC to 1.3 GHz	20 dB	20 dB
1.3 GHz to $F_{max}$	10 dB	10 dB
<b>Maximum operating level:</b>	+20 dB	+20 dB
<b>Damage level:</b>	+30 dB	+30 dB
<b>RF connectors:</b>		
<b>RF input:</b>	50 ohm Type-N (f)	50 ohm Type-N(f)
<b>All others:</b>	50 ohm Type-N (f)	75 ohm Type-N(f)
<b>Includes:</b>		3 ea. HP 11852B 50 to 75 ohm min. loss pads
<b>Recommended accessories:</b>	HP 11851B RF Cable Kit	

#### HP 11667A 50 ohm Power Splitter

<b>Frequency range:</b>	DC to 18 GHz
<b>Typical insertion loss:</b>	6 dB
<b>Equivalent source match:</b>	26 dB to 4 GHz 21 dB to 8 GHz 17 dB to 18 GHz
<b>Tracking:</b> (between output arms)	$\pm 15$ dB to 4 GHz $\pm 2$ dB to 8 GHz $\pm 25$ dB to 18 GHz
<b>Maximum operating level:</b>	$\pm 27$ dBm
<b>Connectors:</b>	50 ohm Type-N (f)
<b>Opt 001:</b>	Type-N (m) on RF input Type-N (f) on outputs
<b>Opt 002:</b>	Type-N (f) on RF input precision 7 mm on outputs
<b>Dimensions:</b>	46 mm H x 52 mmW x 19 mm D (1.8 x 2.0 x 0.7 in)
<b>Recommended accessories:</b>	HP 11851B RF Cable Kit

## HP 8753D Accessories (continued)

### HP 11852B 50 to 75 ohm Minimum Loss Pad

<b>Frequency range:</b>	DC to 2.0 GHz
<b>Nominal insertion loss:</b>	5.7 dB
<b>Return loss:</b>	26 dB (50 ohm), 30 dB (75 ohm)
<b>Maximum input power:</b>	250 mW (+24 dBm)
<b>Connectors:</b>	50 ohm Type-N (f) to 75 ohm Type-N (m) std, 50 ohm Type-N (m) to 75 ohm Type-N (f) with option 004
<b>Dimensions:</b>	14 mm D x 70 mm L (0.56 in. x 2.75 in.)
<b>Weight:</b>	Net 0.1 kg (0.316 lb)

### 50 ohm Accessory Kits

The HP 11853A 50 ohm type-N and the HP 11854A 50 ohm BNC accessory kits provide the RF components generally required when using either the HP 85044A, HP 85046A, HP 85047A or the HP 11850C with the HP 8753D option 011 when measuring devices having 50 ohm Type-N or BNC connectors. These kits are supplied with a convenient storage case.

#### HP 11853A 50 Ohm Type-N Accessory Kit

**Includes:**

Type-N (f) short	HP 11511A
Type-N (m) short	HP 11512A
Type-N (m) to N (m) adapter	HP 1250-1475
Type-N (f) to N (f) adapter	HP 1250-1472

#### HP 11854A 50 Ohm BNC Accessory Kit

**Includes:**

Type-N (m) to BNC female adapter	HP 1250-1476
Type-N (m) to BNC male adapter	HP 1250-1473
Type-N (f) to BNC male adapter	HP 1250-1477
Type-N (f) to BNC female adapter	HP 1250-1474
BNC (m) short	HP 1250-0929

### 75 ohm Accessory Kits

The HP 11855A 75 ohm Type-N and the HP 11856A 75 ohm BNC accessory kits provide the RF components generally required when using either the HP 85044B, HP 85046B or the HP 11850D power splitter with the HP 8753D option 011 when measuring devices having 75 ohm type N or BNC connectors. These kits are supplied with a convenient storage case.

### HP 11855A 75 Ohm Type-N Accessory Kit

**Includes:**

Type-N (f) short	HP 1250-1531
Type-N (m) short	HP 1250-1530
Type-N (m) to N (m) adapter	HP 1250-1528
Type-N (f) to N (f) adapter	HP 1250-1529
Type-N (m) termination	HP 1250-1532

### HP 11856A 75 Ohm BNC Accessory Kit

**Includes:**

Type-N (m) to BNC (f) adapter	HP 1250-1535
Type-N (m) to BNC (m) adapter	HP 1250-1533
Type-N (m) to BNC (m) adapter	HP 1250-1534
Type-N (f) to BNC (m) adapter	HP 1250-1536
BNC (m) short	HP 1250-0929
BNC (m) termination	HP 11652-60010

### HP 85024A High Frequency Probe

This versatile probe makes it easy to perform in-circuit sweep measurements. An input capacitance of only 0.7 pF shunted by 1 megohm of resistance permits high frequency probing without adversely loading the circuit. High probe sensitivity allows measurements to be made while taking advantage of the full dynamic range of the instrument. Two probes may be powered directly from the front panel of the HP 8753D, one probe from the front panel of the HP 8752C.

#### Specifications

<b>Input capacitance (at 500 MHz)</b>	<0.7 pF (nominal)
<b>Input resistance</b>	1 Megohm (nominal)
<b>Bandwidth</b>	300 kHz to 3 GHz
<b>Gain (at 500 MHz)</b>	0 dB $\pm$ 1 dB
<b>Frequency response</b>	$\pm$ 1 dB (300 kHz to 1 GHz) +2, -3 dB, (1 GHz to 3 GHz)
<b>Input voltage for &lt;1 dB compression</b>	0.3 V
<b>Supplement characteristics:</b>	
<b>Noise figure</b>	< 50 dB (<100 MHz) < 25 dB (100 MHz to 3 GHz)

**Includes:**

Type-N (m) Adapter	HP 11880A
10:1 Divider	HP 11881A
Spare 12 mil probes	HP 85024-20012
2.5-inch Ground Lead	HP 01223-61302
Hook Tip	HP 10229
Spanner Tip	HP 5060-0549
Probe Tip Nut Driver	HP 8710-1806

## HP 8753D Accessories (continued)

### HP 8347A RF Amplifier

This general purpose broadband amplifier is designed for maximum reliability and configured for convenience when interfacing with the HP 8753D. The HP 8347A RF amplifier delivers increased power across a 300 kHz to 3 GHz frequency range. Adjustable leveled output power between +20 dBm (100 mW) to +5 dBm (3.16 mW) can be achieved.

The HP 8347A provides leveled output power without using an external coupler and detector, since these parts are built-in. The external ALC can be directly connected to the External AM input on the HP 8753D. This capability is especially useful for achieving high dynamic range measurements at faster sweep rates.

#### Specifications

<b>Frequency:</b>	100 kHz to 3 GHz
<b>Gain:</b>	25 dB minimum
<b>Output power (leveled):</b>	+5 dBm to +20 dBm (adjustable)
<b>Maximum output power:</b>	24 dBm (typical)
<b>leveled power flatness:</b>	±1.5 dB
<b>Impedance:</b>	50 ohms nominal
<b>SWR:</b>	
Input:	2.2:1 max
Output:	1.6:1 (ALC on)
<b>Spectral purity:</b>	
Harmonics:	-20 dBc at dBm
Third Order Intercept:	+30 dBm (nominal)
<b>Typical noise figure:</b>	13.5 dB
(100 MHz to 3 GHz)	
<b>RF connectors:</b>	Type N female
<b>Dimensions:</b>	102 H x 213 W x 297 mm D (4.0" x 8.4" x 11.7")
<b>Weight:</b>	net 3.5 kg (7.7 lb)

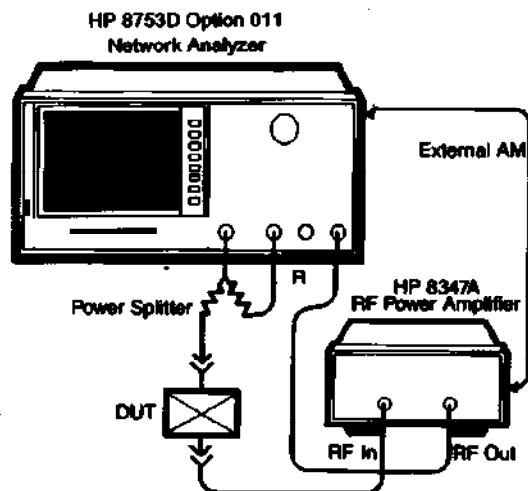

Extended Dynamic Range Test Configuration

### Transistor test fixtures

#### HP 11600B and HP 11602B Transistor Fixtures

These units allow RF measurements to be made on leaded transistors, FET's, diodes, varactors, etc. when used with the HP 8753D from 300 kHz to 2 GHz. Included for calibration of the transistor fixtures are two calibration references; a short circuit termination and a 50 ohm through-section. The HP 11600B accepts TO-18/TO-72 packages and the HP 11602B accepts TO-5/TO-12 packages.

<b>Impedance:</b>	50 ohms nominal
<b>Connectors:</b>	Precision 7 mm connectors
<b>Option 001:</b>	Type N 50 ohm female connectors
<b>Recommended accessories:</b>	The HP 11858A transistor fixture adapter is recommended for use when using the HP 85046A or the HP 85047A S-parameter test set.

#### HP 11858A Transistor Fixture Adapter

Provides a rigid RF cable interconnection (horizontal to vertical test port orientation) between the HP 85046A or HP 85047A S-parameter test set and the HP 11600B/11602B transistor test fixtures. All connectors are precision 7 mm.

#### HP 11608A Transistor Fixture

Provides the capability of completely characterizing stripline transistors when used with the HP 8753D or the HP 85046A or HP 85047A S-parameter test sets. A through-line microstrip and bolt-in grounding structure machineable for special packages is included.

<b>Frequency range:</b>	DC to 12.4 GHz
<b>Impedance:</b>	50 ohms nominal
<b>Return Loss:</b>	> 26 dB to 4 GHz; > 23 dB, 4 to 8 GHz; > 19 dB, 8 to 12.4 GHz

#### Package styles:

Option 003: 0.205 inch diameter packages. Includes a short circuit termination and a 50 ohm through-section for calibration.

**Connectors:** Precision 7 mm

### HP 85043D Systems Cabinet

The HP 85043D systems cabinet has been ergonomically designed specifically for the HP 8753D option 011 and the HP 85046A/B or HP 85047A S-parameter test sets. The 132 cm (52-inch) system cabinet includes a bookcase, a drawer, and a convenient work surface.



# HP 8752C Accessories

## Calibration and Verification Kits

### Calibration Kits

Vector accuracy enhancement procedures require that the systematic errors of the measurement system be characterized by measuring known devices (standards) on the system over the frequency range of interest. The HP 8752C is fully integrated and has a factory calibration so systematic errors have been reduced to the point where measurement calibration may not be necessary. The following calibration kits contain precision standards in different connector types. Refer to the information on these kits in the "HP 8753D Accessories" section for specifications and typical characteristics.

#### HP 85032B Option 001 50 ohm Type-N Calibration Kit

Contains precision 50 ohm Type-N standards used to calibrate the HP 8752C for measurement of devices with 50 ohm Type-N connectors. This kit can also be used to perform a system verification. Option 001 removes the precision phase-matched 7 mm to type-N adapters.

**Includes:**

N-male 50 ohm term.	HP 00909-60009
N-female 50 ohm term.	HP 00909-60010
N-male short circuit	HP 85032-60008
N-female open circuit	HP 85032-60009
N-male open circuit	HP 85032-60007
N-female open circuit	HP 85032-20001

#### HP 85033D Option 001 3.5 mm Calibration Kit

Contains precision 3.5 mm standards to calibrate the HP 8752C for the measurement of devices with 3.5 mm or SMA connectors. Option 001 removes the precision phase-matched 7 mm to 3.5 mm adapters.

**Includes:**

3.5 mm-male 50 ohm term.	HP 85033-60009
3.5 mm-female 50 ohm term.	HP 85033-60010
3.5 mm-male short	HP 85033-60013
3.5 mm-female short	HP 85033-60014
3.5 mm-male open w/ext	HP 85033-60011
3.5 mm-female open w/ext	HP 85033-60012

#### HP 85036B 75 ohm Type-N Calibration Kit

Contains a set of precision 75 ohm Type N standards to calibrate the HP 8752C for measurement of devices with 75 ohm type-N connectors. Precision phased matched adapters are included for accurate measurements of non-insertable devices.

**Includes:**

N-male 75 ohm term.	HP 00909-60019
N-female 75 ohm term.	HP 00909-60020
N-female 75 ohm short	HP 85036-60011
N-male 75 ohm short	HP 85036-60012
N-female open	HP 85032-20001
N-male open	HP 85032-60007
N-male to N-male 75 ohm adapter	HP 85036-60013
N-female to N-female 75 ohm adapter	HP 85036-60014
N-male to N-female 75 ohm adapter	HP 85036-60015

#### HP 85039A Type-F Calibration Kit

Contains a set of 75 ohm type-F standards to calibrate the HP 8753D and 75 ohm test set for the measurement of devices with type-F connectors.

**Includes:**

F-male 75 ohm termination	HP 0955-0724
F-male 75 ohm short	HP 0955-0726
F-male open	HP 0955-0725
N-male to F-male 75 ohm adapter	HP 1250-2488
F-female to F-female 75 ohm adapter	HP 1250-2489
N-female to F-male 75 ohm adapter	HP 1250-2490

#### HP 11878A Adapter Kit

The HP 11878A Adapter Kit provides the RF components generally required when a SMA or 3.5 mm device needs to be measured with the HP 8752A standard Type-N configuration. This kit is supplied with a convenient storage case.

**Includes:**

Type N male to 3.5 mm male adapter	HP 1250-1743
Type N male to 3.5 mm female adapter	HP 1250-1744
Type N female to 3.5 mm female adapter	HP 1250-1745
Type N female to 3.5 mm male adapter	HP 1250-1750

### Verification kits

Verification of the HP 8752C system simply requires the HP 85032B, HP 85032B Option 001 or HP 85036B Option 001 calibration kits. No additional hardware is required.

### Test Port Return Cable

Hewlett-Packard supplies a 610 mm (24") Type-N RF cable with every HP 8752C. An additional cable can be ordered as option AFN (50 ohm) or AFP (75 ohm), or replacement cables can be ordered separately. Since the single cable is characterized as part of the internal transmission correction, when a new cable or a pair of cables is used, the internal calibration should be checked out and corrected if necessary.

610 mm (24") 50 ohm Type-N RF cable	HP 8120-5639
610 mm (24") 75 ohm Type-N RF cable	HP 8120-2408

These cables have male connectors on both ends.

Accessories provided to make 75 ohm measurements with the HP 8753D, such as the HP 85036B 75 ohm Type-N Calibration Kit and the HP 11852B 50 to 75 ohm Minimum Loss Pads, may be used effectively with the HP 8752C.

## Footnotes

1. 90 dB, 30 kHz to 50 kHz
2. 100 dB, 300 kHz to 16 MHz due to fixed spurs.
3. These measurement uncertainty curves utilize an RSS model for the contribution of random errors such as noise, typical connector repeatabilities, and test set switch; with a worst-case model for the contributions of dynamic accuracy and residual systematic errors.
4. The graphs shown for transmission measurements assume a well-matched device ( $S_{11} = S_{22} = 0$ ).
5. The graphs shown for reflection measurements apply to either a one-port device or a two-port device with more than 6 dB insertion loss.
6. Typical performance
7. At  $25^{\circ}\text{C} \pm 5^{\circ}\text{C}$ , relative to 0 dBm output power for the HP 8753D, +10 dBm output power for the HP 8753D Option 011, or -5 dBm output power for the HP 8752C.
8. Typical below 300 kHz
9. 16 MHz to 3 GHz
10. 16 MHz to 2 GHz
11. The HP 8753D RF source characteristics and measurement accuracy in this mode are dependent on the stability of the external LO source. The RF source tracks the LO to maintain a stable IF signal at the R channel receiver input. Degradation in accuracy is negligible when using an HP 8642A/B or HP 8656B RF signal generator as the LO source.
12. See the HP 8753D descriptions and options for a functional description. Measurement accuracy is dependent on the stability of the input signal.
13. Marker resolution for magnitude, phase and delay is dependent upon measured value. Resolution is limited to five digits.
14. Does not include error from the HP 8753D source and receiver harmonics.
15. One-port calibration, with a 3 kHz IF bandwidth. Includes system retrace time, but does not include bandswitch time. Time domain gating is assumed off.
16. Same as footnote 15, but for an S21 measurement with full two-port calibration. Includes RF switching time.
17. Option 010 only, gating off.
18. Measured with an HP 9000 Series 300 computer.
19. Fmax is the upper frequency limit of the associated test set.
20. Degrees, specified as deviation from linear phase.
21. Typical repeatability is  $\pm 0.01$  dB.
22. These can be greatly improved with accuracy enhancement.
23. Some degradation at environmental extremes below 600 kHz.
24. Degrees, specified as deviation from linear phase.
25. Typical from 2 to 3 GHz for instruments with Option 075.
26. For HP 8753D Option 011 and Option 006, linearity is specified for the ranges of (-5 to +13 dBm) and (+13 to +18 dBm).

**For more information, call your local HP sales office listed in your telephone directory or an HP regional office listed below for the location of your nearest sales office.**

**United States of America:**  
1 800 452 4844

**Canada:**  
(416) 206 4726

**Japan:**  
(81) 426 48 0722

**Latin America:**  
Miami, Florida  
(305) 267 4220

**Australia/New Zealand:**  
(008) 13 1347  
Melbourne callers:  
272 2555

**Asia Pacific:**  
Hong Kong  
(852) 599 7070

Korea  
(2) 769 0800

Taiwan  
(2) 717 9524

---

Singapore  
(65) 291 8554

India  
(11) 690 355

PRC  
(1) 505-3888

**In Europe, Africa, and Middle East, please call your local HP sales office or representative:**

**Austria/East Central Europe:**  
(1) 25000-0

**Belgium and Luxembourg:**  
(02) 778 31 11

**Denmark:**  
45 99 10 00

**Finland:**  
(90) 88 721

**France:**  
(1) 69.82.65.00

**Germany:**  
(06172) 16 0

**Greece:**  
(01) 68 96 411

**Ireland:**  
(01) 284 4633

**Israel:**  
(03) 5380 333

**Italy:**  
(02) 92 122 241

**Netherlands:**  
(020) 547 6669

**Norway:**  
(22) 73 56 00

**Portugal:**  
(11) 301 73 30

**South Africa:**  
(011) 806 1000

**Spain:**  
900 123 123

**Sweden:**  
(08) 750 20 00

**Switzerland:**  
(01) 735 7111

**Turkey:**  
(312) 425 83 13

**United Kingdom:**  
(0344) 366 666

**For countries not listed, contact Hewlett-Packard, International Sales Europe, Geneva, Switzerland  
Tel: +41-22-780-4111  
Fax: +41-22-780-4770**

**Data Subject to Change  
Copyright © 1994  
Hewlett-Packard Company  
Printed in U.S.A. 11/94  
5962-9770E**