

Agilent 83000A Series Microwave System Amplifiers

Technical Overview

Agilent Technologies Microwave System Amplifiers

- 83006A** 10 MHz to 26.5 GHz
- 83017A** 500 MHz to 26.5 GHz
- 83018A** 2 to 26.5 GHz
- 83020A** 2 to 26.5 GHz
- 83050A** 2 to 50 GHz
- 83051A** 45 MHz to 50 GHz

Features

- Ultra broadband to 50 GHz
- Up to 1 watt output power
- Compact size

Agilent model (dBm)	Frequency (GHz)	Gain (dB)	Pout
83006A	0.01 to 26.5	20	13
83017A	0.5 to 26.5	25	18
83018A	2 to 26.5	27	24
83020A	2 to 26.5	30	30
83050A	2 to 50	21	18
83051A	0.045 to 50	23	12*

* 10 dbm 45 to 50 GHz



The Agilent microwave system amplifiers are compact, off-the-shelf amplifiers designed for system designers and integrators. This family of amplifiers provides power where you need it to recover system losses and to boost available power in RF and microwave ATE systems.

The ultrabroad bandwidth from 10 MHz to 50 GHz allows the designer to replace several narrow bandwidth amplifiers with a single Agilent amplifier, eliminating the need for crossover networks or multiple bias supplies.

The 83050A power amplifier and 83051A preamplifier expand frequency performance to 50 GHz, while the 1 Watt 83020A offers broadband power to 26 GHz. The small amplifier

footprint allows for simple in-line insertion to existing system blocks that require amplification. The standard 83017A, 83018A, and 83020A include internal directional detectors for external leveling applications.

The 83020A is optionally available without the coupler-detector providing up to +30 dBm and +25 dBm, respectively. With excellent noise figure relative to their broad bandwidth and high gain, these amplifiers significantly improve system noise figure and dynamic range. These products come equipped with a low profile heat sink, an integral mounting bracket, and a two-meter DC power supply cable. Thermal and power supply design allows fast, easy integration into most measurement systems.



Agilent Technologies

Applications

Small envelope size makes the Agilent Technologies family of microwave system amplifiers ideal for automated test and benchtop applications, offering the flexibility to place power where you need it.

Boost source output power

Increase output power from microwave sources to increase test system dynamic range. Drive high input power devices such as TWTs, mixers, power amps, or optical modulators. Drive test devices into compression for device characterization.

Recover systematic losses

The microwave system amplifiers help solve the power loss from connectors, cables, switches, and signal routing components which consume valuable source power. Long transmission paths, common in antenna applications, are particularly susceptible to such losses.

Level source power

By using feedback to an external source ALC input, system designers can level output power at the test port, negating the effects of postsweeper reflections and losses.

Simply route the directional detector output to the source external ALC input connector. The figures at right show typical results.

The 83020A, 83018A, and 83017A feature an integral directional detector to supply feedback. To level an 83006A amplifier, use the 0.01 to 26.5 GHz 83036C directional detector or the 1 to 26.5 GHz 87300C coupler with an 8474C detector.

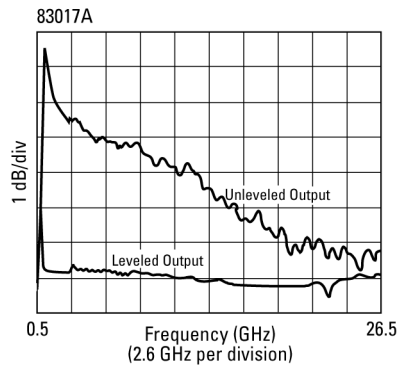
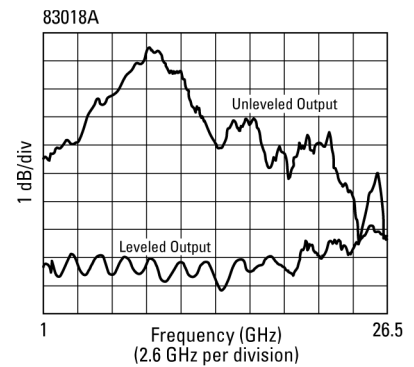
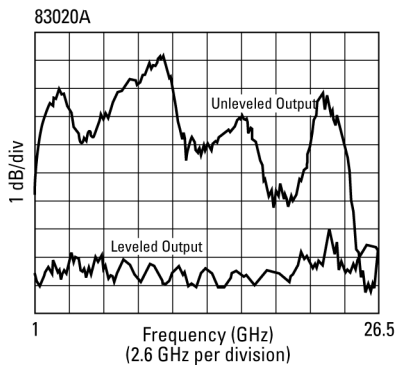
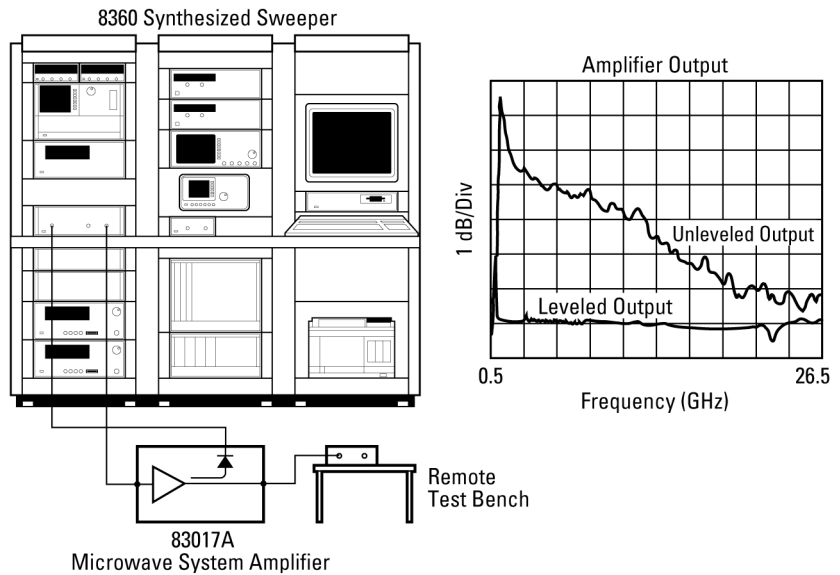

Improve Measurements

The 83006A, 83017A, and 83051A preamplifiers increase the sensitivity and dynamic range of spectrum analyzers. Add a preamplifier to noise figure measurement systems to significantly lower system noise figure. The table below shows typical system noise figure reduction achievable with these amplifiers. Note that the reduced system noise figure is dominated by the preamplifier noise figure. See Application Note 57-2, literature number 5952-3706.

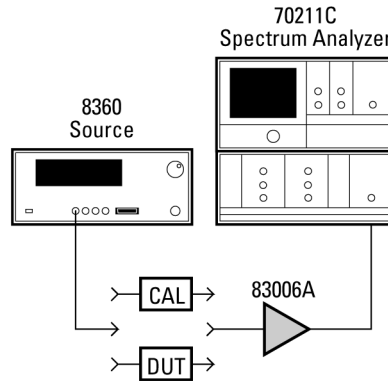

SENSITIVITY IMPROVEMENT

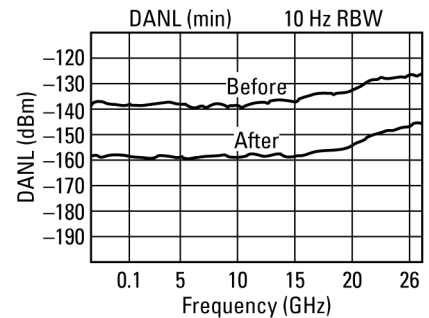

Benchtop gain block

Benchtop microwave design tasks often require amplification to measure low level output characteristics, improve system dynamic range, perform saturation tests, or boost power levels. The Agilent family of system amplifiers offers small size and immediate, off-the-shelf solutions to microwave design, production, or test engineers.

Pulse parameter measurements

Fast rise time and multi-octave bandwidth make these amplifiers attractive for fast pulse parameter measurements. The 0.01, 0.5, and 2 GHz cutoff frequencies make them more useful for RF or impulse measurements with low duration times.

$$F_{\text{new}} = F_{\text{pa}} + \frac{F_{\text{sys}} - 1}{G_{\text{pa}}}$$

All terms linear

Typical noise figure improvement

Amp model	Freq (GHz)	Max NF(dB)	Min gain (dB)	System noise figure (F _{sys}) without preamp (dB)						
				13	15	18	20	23	25	30
83006A	0.01–0.2	13	20	—	13.1	13.1	13.2	13.4	13.6	14.8
	0.2–18	8		8.1	8.2	8.4	8.6	9.2	9.8	12.1
	18–26.5	13		—	13.1	13.1	13.2	13.4	13.6	14.8
83017A	0.5–18	8	25	8.0	8.1	8.1	8.2	8.4	8.6	9.8
	18–26.5	13		—	13.0	13.0	13.1	13.1	13.2	13.6
83018A	1–2	10	23	10.0	10.1	10.1	10.2	10.4	10.6	11.8
	2–20	10	27	10.0	10.0	10.1	10.1	10.2	10.3	10.8
	20–26.5	13	23	—	13.0	13.1	13.1	13.2	13.3	14.0
83020A	1–20	10	30	10.0	10.0	10.0	10.0	10.1	10.1	10.4
	20–26.5	13	27	—	13.0	13.1	13.1	13.1	13.1	13.4
85050A	2–26.5	6	21	6.1	6.2	6.3	6.5	7.0	7.5	9.5
	26.5–50	10		10.0	10.1	10.1	10.2	10.4	10.6	11.8
83051A	0.045–2	12	23	12.0	12.0	12.1	12.1	12.3	12.4	13.2
	2–26.5	6		6.1	6.2	6.3	6.5	7.0	7.5	9.5
	26.5–50	10		10.0	10.1	10.1	10.2	10.4	10.6	11.8

Product specifications

Model number	83006A	83017A	83018A
Frequency range	10 MHz–26.5 GHz	0.5–26.5 GHz	2–26.5 GHz
Small signal gain	20 dB min	25 dB min	23 dB typ 1–2 GHz 27 dB min 2–20 GHz 23 dB min 20–26.5 GHz
Small signal gain flatness	±5 dB max 0.01–5 GHz ±3 dB max 5–26.5 GHz	±5 dB max 0.5–2 GHz ±5 dB max 2–26.5 GHz	±5 dB typ
Output power (At P max)	+18 dBm typ 0.01–10 GHz +16 dBm typ 10–20 GHz +14 dBm typ 20–26.5 GHz	+20 dBm typ 0.5–20 GHz +15 dBm typ 20–26.5 GHz	+23 dBm typ 1–2 GHz ² +24 dBm min 2–20 GHz ^{2,3} +21 dBm min 20–26.5 GHz ^{2,3}
(At 1 dB compression)	+13 dBm min 0.01–20 GHz +10 dBm min 20–26.5 GHz	+18 dBm min 0.5–20 GHz +18 dBm–0.75 dB/GHz (20<f<26.5 GHz)	+22 dBm typ 1–2 GHz +22 dBm min 2–20 GHz +17 dBm min 20–26.5 GHz
Leveled output power Flatness ¹	N/A	±1.1 dB 0.5–26.5 GHz at 12 dBm ±1.5 dB 0.5–20 GHz at 18 dBm	±1.5 dB 1–26.5 GHz at 17 dBm
Noise figure	<13 dB typ 0.01–0.1 GHz <8 dB typ 0.1–18 GHz <13 dB typ 18–26.5 GHz	<8 dB typ 0.5–20 GHz <13 dB typ 20–26.5 GHz	<10 dB typ 1–20 GHz <13 dB typ 20–26.5 GHz
Harmonics (At spec'd value of P1 dBC)	–25 dBc 0.01–11 GHz –25 dBc typ 11–13.25 GHz	–20 dBc 0.5–11 GHz –20 dBc typ 11–13.25 GHz	–22 dBc typ 1–2 GHz –19 dBc 2–11 GHz –19 dBc typ 11–13.25 GHz
Harmonics (At spec'd max power)	N/A	N/A	–20 dBc typ 1–2 GHz –17 dBc typ 2–11 GHz –17 dBc typ 11–13.25 GHz
Input SWR	2.6:1	2.6:1	3:1 typ 1–2 GHz 3:1 2–26.5 GHz
Output SWR	2.8:1 0.01–18 GHz 3.2:1 18–26.5 GHz	2.6:1	7.0:1 typ 1–2 GHz 4.5:1 2–10 GHz 2.2:1 10–26.5 GHz
Non-harmonically related spurious	–65 dBc typ	–65 dBc typ	–65 dBc typ
Rise time	400 ps typ	310 ps typ	275 ps typ
Third order intercept (TOI)	30 dBm typ at 2 GHz 20 dBm typ at 26.5 GHz	30 dBm typ at 2 GHz 20 dBm typ at 26.5 GHz	36 dBm typ 2–20 GHz 31 dBm typ 20–26.5 GHz
Impedance	50 Ω typ	50 Ω typ	50 Ω typ
Reverse isolation (typ)	–65 dB	–65 dB	–55 dB at 1 GHz +0.95 dB/GHz
Survival input power	+23 dBm max	+23 dBm max	+23 dBm max
Power dissipation	6 W	9 W	24 W

1. At min specified P1 dBC within given frequency band

2. P max measured with 0 dBm input

3. Option 001 Pmax +25 dBm 2–20 GHz, +22 dBm 20–26.5 GHz

Product specifications (continued)

Model number	83020A	83050A	83051A
Frequency range	2–26.5 GHz	2–50 GHz	45 MHz–50 GHz
Small signal gain	30 dB typ 1–2 GHz 30 dB min 2–20 GHz 27 dB min 20–26.5 GHz	21 dB min	23 dB min
Small signal gain flatness	±5 dB typ	±3.5 dB max	±3.5 dB max
Output power (At P max)	+30 dBm typ 1–2 GHz ² +30 dBm min 2–20 GHz ^{2,3} +30 dBm –0.7 dB/GHz ^{2,3} (20<f<26.5 GHz)	+20 dBm 2–40 GHz +19 dBm–0.2 dB/GHz (40<f<50 GHz)	+12 dBm to 45 GHz +10 dBm 45–50 GHz
(At 1 dB compression)	+28 dBm typ 1–2 GHz +28 dBm min 2–20 GHz +28 dBm–0.7 dB/GHz (20<f<26.5 GHz)	+15 dBm 2–40 GHz +13 dBm 40–50 GHz	+8 dBm 45 MHz–45 GHz +6 dBm 45–50 GHz
Leveled output power Flatness ¹	±1.5 dB typ 1–26.5 GHz At 23 dBm	N/A	N/A
Noise figure	<10 dB typ 1–20 GHz <13 dB typ 20–26.5 GHz	<6 dB typ 2–26.5 GHz <10 dB typ 26.5–50 GHz	<12 dB typ 45 MHz–2 GHz <6 dB typ 2–26.5 GHz <10 dB typ 26.5–50 GHz
Harmonics (At Spec'd value of P1 dBC)	–22 dBc typ 1–2 GHz –20 dBc typ 2–11 GHz –17 dBc typ 11–13.25 GHz	–20 dBc typ 2–18 GHz –18 dBc typ 18–25 GHz	–20 dBc typ 45 MHz–18 GHz –18 dBc typ 18–25 GHz
Harmonics (At Spec'd max power)	–20 dBc typ 1–2 GHz –17 dBc typ 2–11 GHz –17 dBc typ 11–13.25 GHz	N/A	N/A
Input SWR	3:1 typ 1–26.5 GHz	2.1 max	2.1 max
Output SWR	7.0:1 typ 1–2 GHz 4.5:1 2–10 GHz 2.2:1 10–26.5 GHz	2.8 max 2–18 GHz 2.1 max 18–50 GHz	2.2 max
Non-harmonically related spurious	–65 dBc typ	–50 dBc typ	–50 dBc typ
Rise time	375 ps typ	250 ps typ	225 ps typ
Third order intercept (TOI)	38 dBm typ 2–20 GHz 33 dBm typ 20–26.5 GHz	27 dBm typ	27 dBm typ
Impedance	50 Ω typ	50 Ω typ	50 Ω typ
Reverse isolation (typ)	–55 dB	–50 dB typ	–50 dB typ
Survival input power	+23 dBm max	+20 dBm max	+20 dBm max
Power dissipation	48 W	11 W	5 W

1. At min specified P1 dBC within given frequency band

2. P max measured with +5 dBm input

3. Option 001 deletes detected output, for Pmax add 0.5 dBm 1–26.5 GHz

Special Applications: Higher performance models available upon request (i.e., higher power, etc.)

Product specifications (continued)

Model number	83006A	83017A	83018A
*Bias voltage and current (nominal) mA	12 ±1 Vdc at 410 ±85 mA –12 ±1 Vdc at 10 ±5 mA	12 ±1 Vdc at 780 ±140 mA –12 ±1 Vdc at 20 ±2 mA	12 ±1 Vdc at 1940 ±123 mA –12 ±1 Vdc at 10 ±5 mA
RF connectors	3.5 mm (f)	3.5 mm (f)	3.5 mm (f)
Detector output	N/A	BNC (f)	BNC (f)
Detector sensitivity	N/A	15 µV/µW	4 µV/µW
Detector polarity	N/A	Negative	Negative
Weight: net shipping	0.64 kg (1.4 lb) 1.32 kg (2.9 lb)	0.64 kg (1.4 lb) 1.32 kg (2.9 lb)	1.8 kg (4.0 lb) 2.9 kg (6.4 lb)

**Do not apply positive voltage before negative voltage.*

Environmental specifications			
Temperature coefficient of gain	–0.07 dB/° C	–0.1 dB/° C	–0.13 dB/° C
Operating temperature	0 to +55° C	0 to +55° C	0 to +55° C
Storage temperature	–40 to +70° C	–40 to +70° C	–40 to +70° C

Other environmental information	
EMC¹	IEC 61326:1997/EN 61326:1997 CISPR 11:1997/EN 55011:1998, Group 1, Class A
Safety	IEC 348:1978/HD 401 S1:1981 CAN/CSA-C22.2 No. 231 (Series M-89)
Moisture resistance	65° C at 95% RH for 10 days per Mil-Std-883C method 1004.5
Random vibration	5.2 G (rms) to 2000 Hz per Mil-Std-883C method 2026 test condition 11A
Shock	1500 G (peak), 0.5 ms per Mil-Std-883C method 2002.3 test condition B
Altitude, non-operating	15,000 m per Mil-Std-883C method 1001 test condition C

1. This ISM device complies with Canadian ICES-001. Cet appareil ISM est conforme a la norme NMB-001 du Canada.

General specifications (continued)

Model number	83020A	83050A	83051A
*Bias voltage and current (nominal)	15 ±1.5 Vdc at 3200 ±800 mA –15 ±0.5 Vdc at 20 ±5 mA	12 ±1 Vdc at 900 ±110 mA –12 ±1 Vdc at 30 ±5 mA	12 ±1 Vdc at 314 ±34 mA –12 ±1 Vdc at 30 ±5 mA
RF connectors	3.5 mm (f)	2.4 mm (f)	2.4 mm (f)
Detector output	BNC (f)	N/A	N/A
Detector sensitivity	1 µV/µW	N/A	N/A
Detector polarity	Negative	N/A	N/A
Weight: net shipping	3.9 kg (8.5 lb) 5.0 kg (11 lb)	0.64 kg (1.4 lb) 1.32 kg (2.9 lb)	0.64 kg (1.4 lb) 1.32 kg (2.9 lb)

**Do not apply positive voltage before negative voltage.*

Environmental specifications			
Temperature coefficient of gain	–0.19 dB/° C	–0.09 dB/° C	–0.09 dB/° C
Operating temperature	0 to +55° C	0 to +55° C	0 to +55° C
Storage temperature	–40 to +70° C	–40 to +70° C	–40 to +70° C

Other environmental information	
EMC¹	IEC 61326:1997/EN 61326:1997 CISPR 11:1997/EN 55011:1998, Group 1, Class A
Safety	IEC 348:1978/HD 401 S1:1981 CAN/CSA-C22.2 No. 231 (Series M-89)
Moisture resistance	65° C at 95% RH for 10 days per Mil-Std-883C method 1004.5
Random vibration	5.2 G (rms) to 2000 Hz per Mil-Std-883C method 2026 test condition 11A
Shock	1500 G (peak), 0.5 ms per Mil-Std-883C method 2002.3 test condition B
Altitude, non-operating	15,000 m per Mil-Std-883C method 1001 test condition C

1. This ISM device complies with Canadian ICES-001. Cet appareil ISM est conforme à la norme NMB -001 du Canada.

Specifications: describe the instrument's warranted performance over the temperature range +20° C to +30° C (unless otherwise noted).

All specifications apply after the instrument's temperature has been stabilized after one hour continuous operation. Typical characteristics are intended to provide information useful in applying the instrument by giving typical but nonwarranted performance parameters. These are denoted as "typical" or "nominal" and apply over the temperature range +20° C to +30° C.

Caution on Electrostatic Discharge: Electrostatic discharge (ESD) can damage or destroy electronic components. It is recommended that these amplifiers, like other electronic components, be installed and operated at a static-free workstation or in an environment where precautions against ESD have been implemented.

Graphical performance data

83006A Amplifier

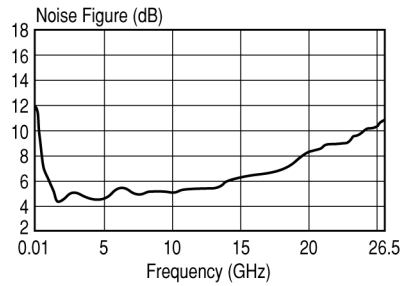
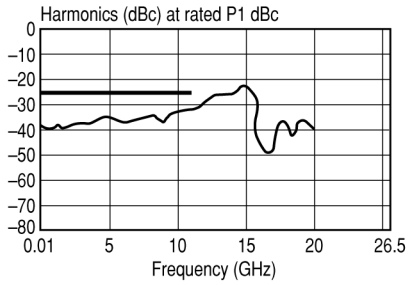
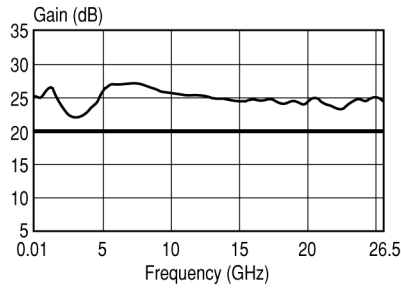
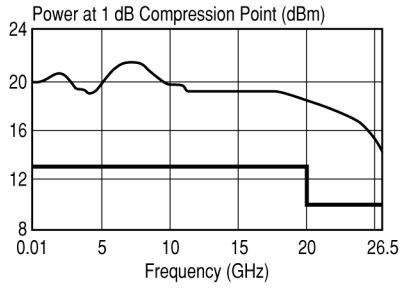

83017A Amplifier

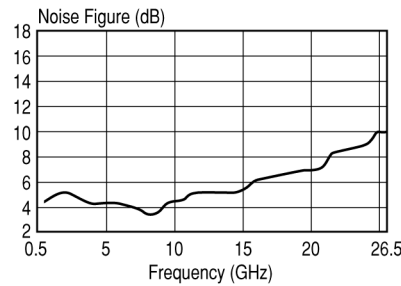
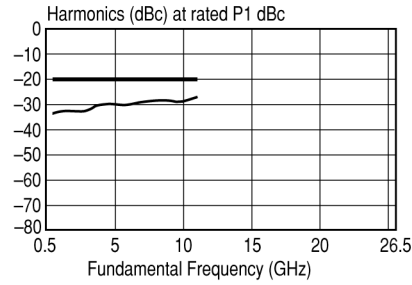
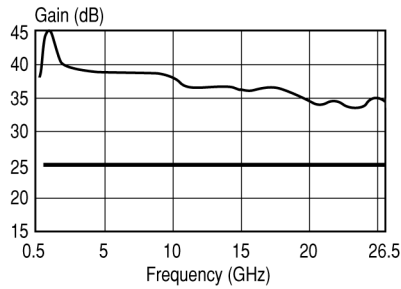
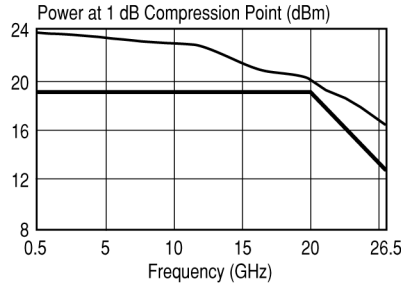

83018A Amplifier

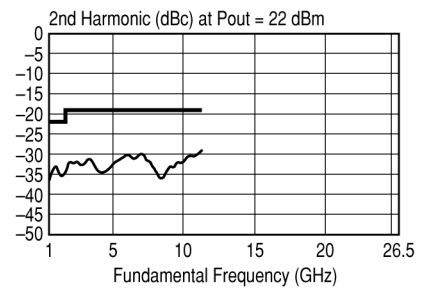
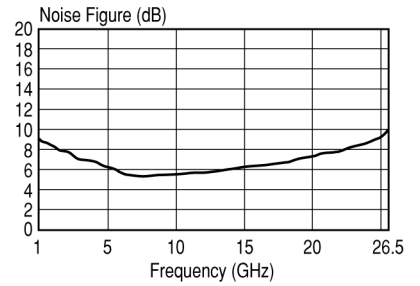
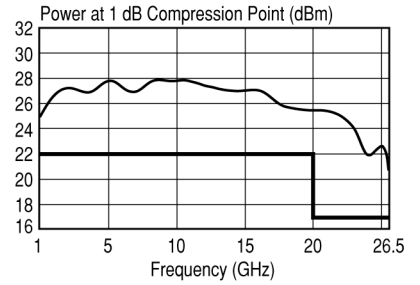
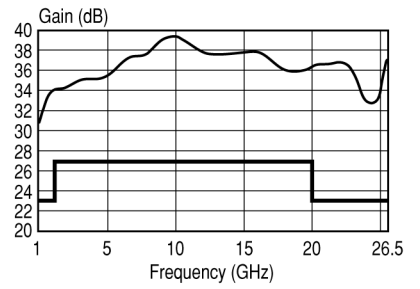
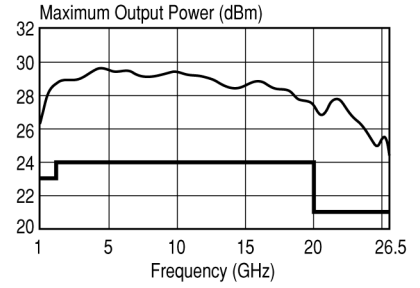

Graphical performance data (continued)

83020A Amplifier

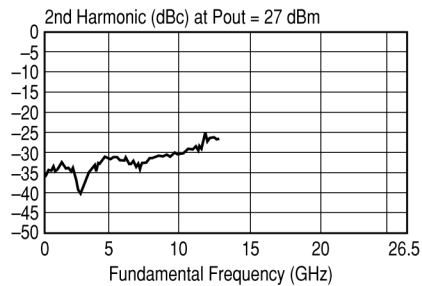
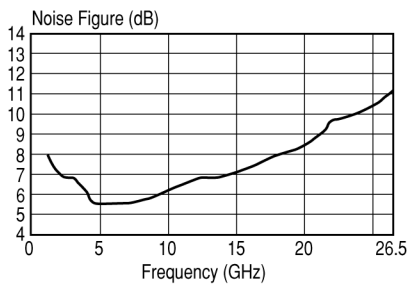
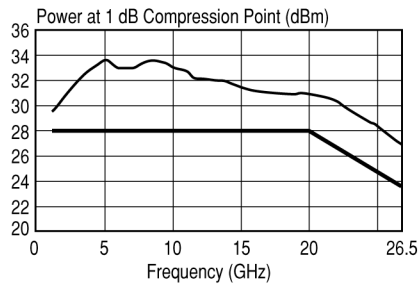
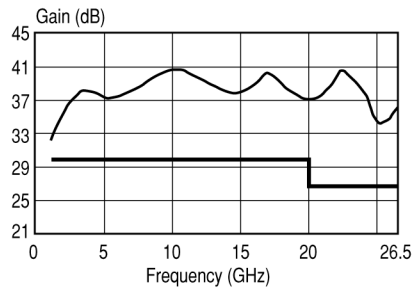
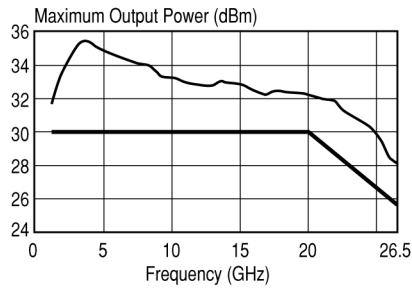

83050A Amplifier

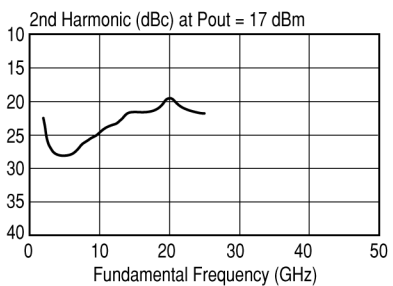
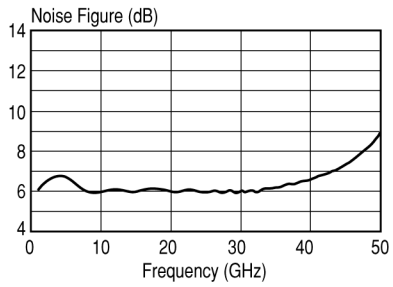
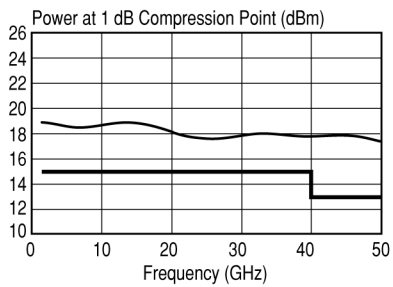
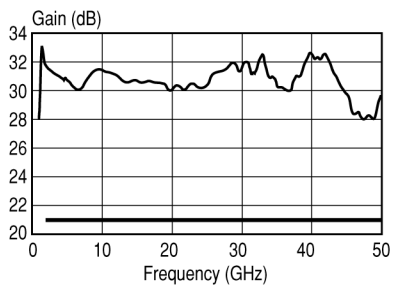
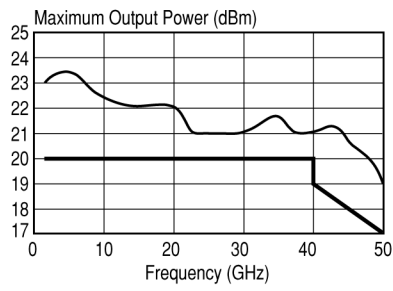

83051A Amplifier

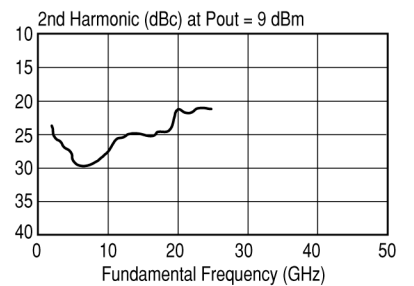
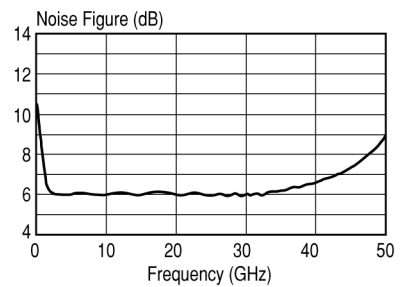
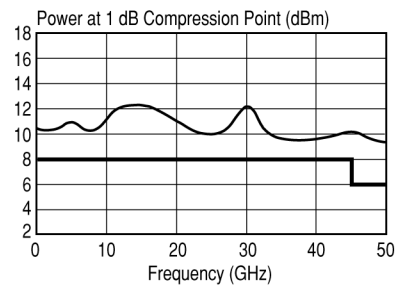
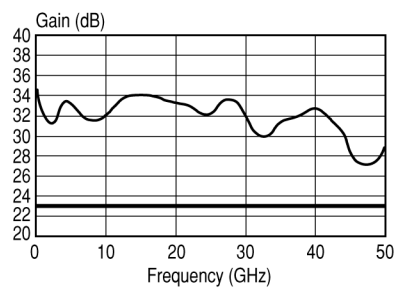
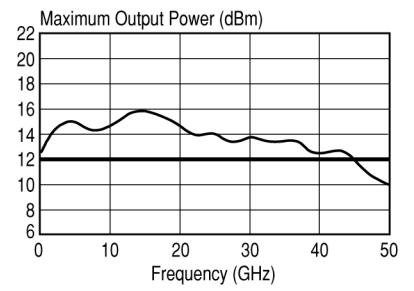

Amplifier outline drawings¹

83006A

Tol = ±0.2 (0.008)

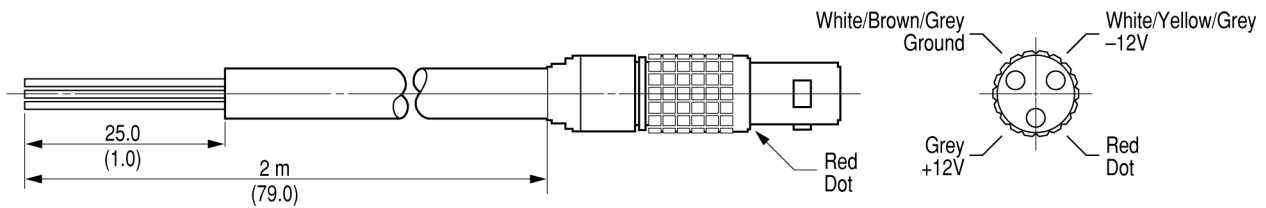
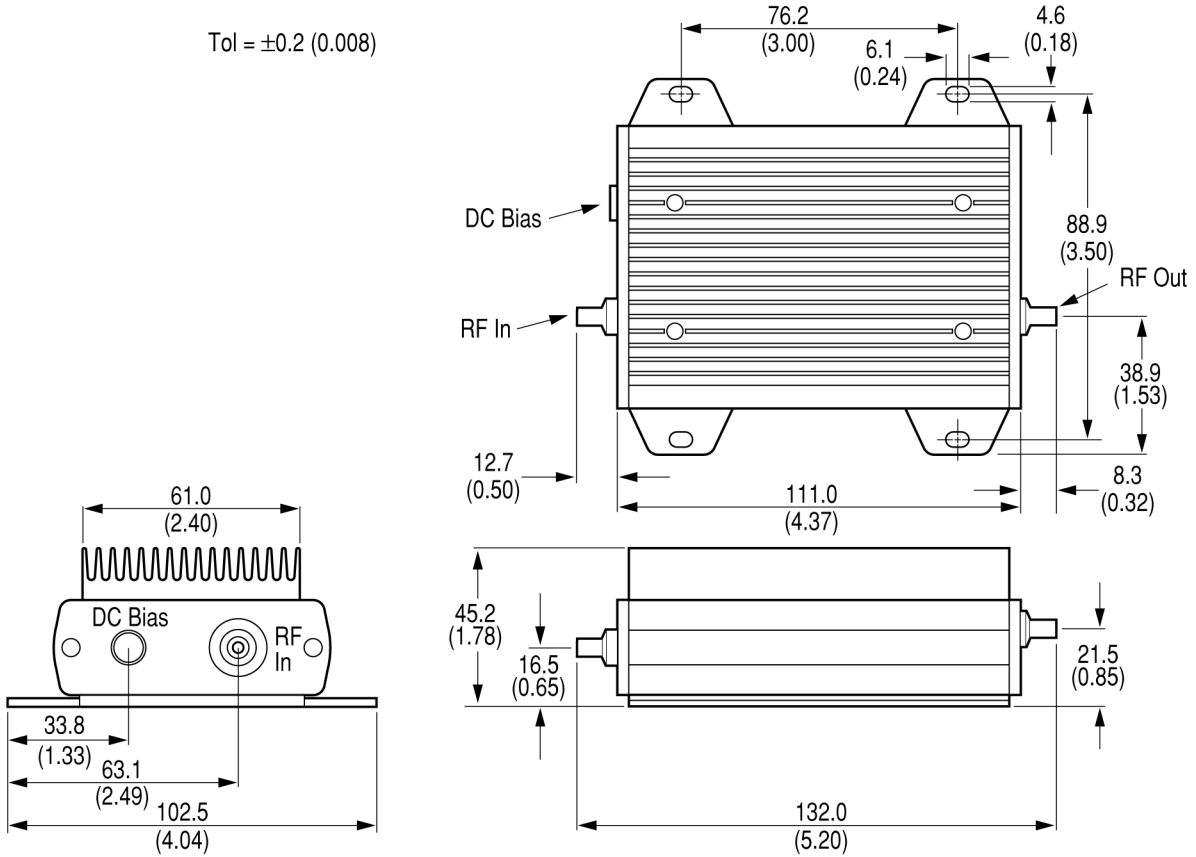

83006-60004 dc bias cable. Cable shipped with 83006A, 83017A, 83018A, 83050A, and 83051A.

1. Dimensions in millimeters and (inches).

Amplifier outline drawings (continued)

83017A

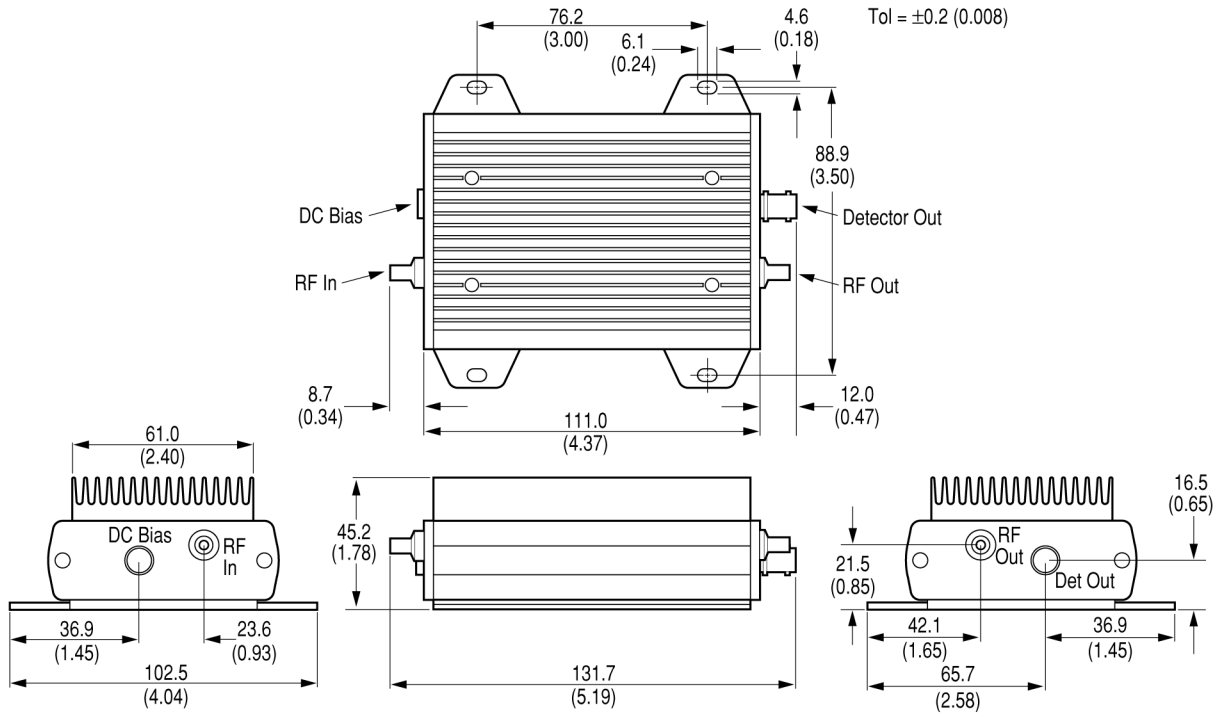

83018A

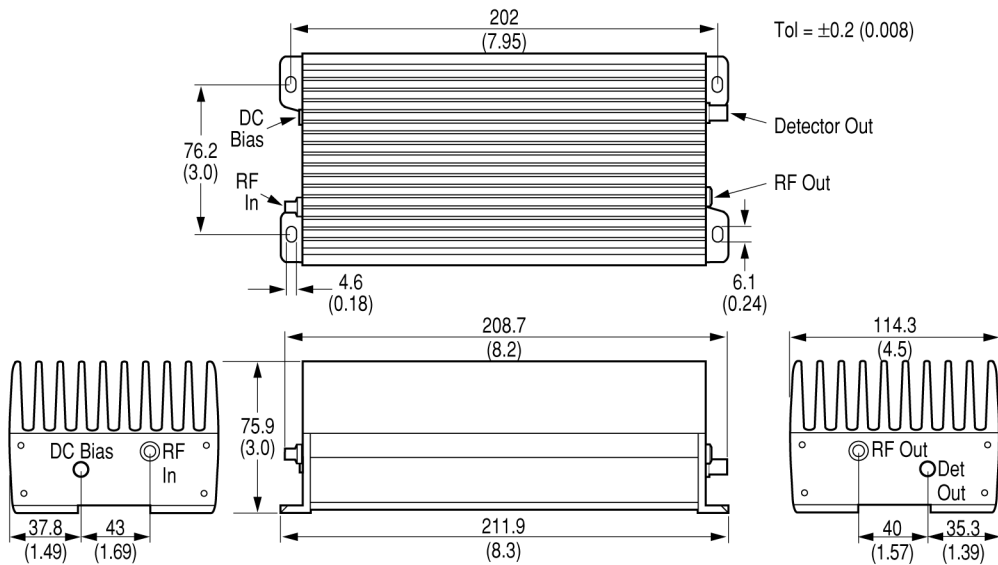

Amplifier outline drawings (continued)

83020A

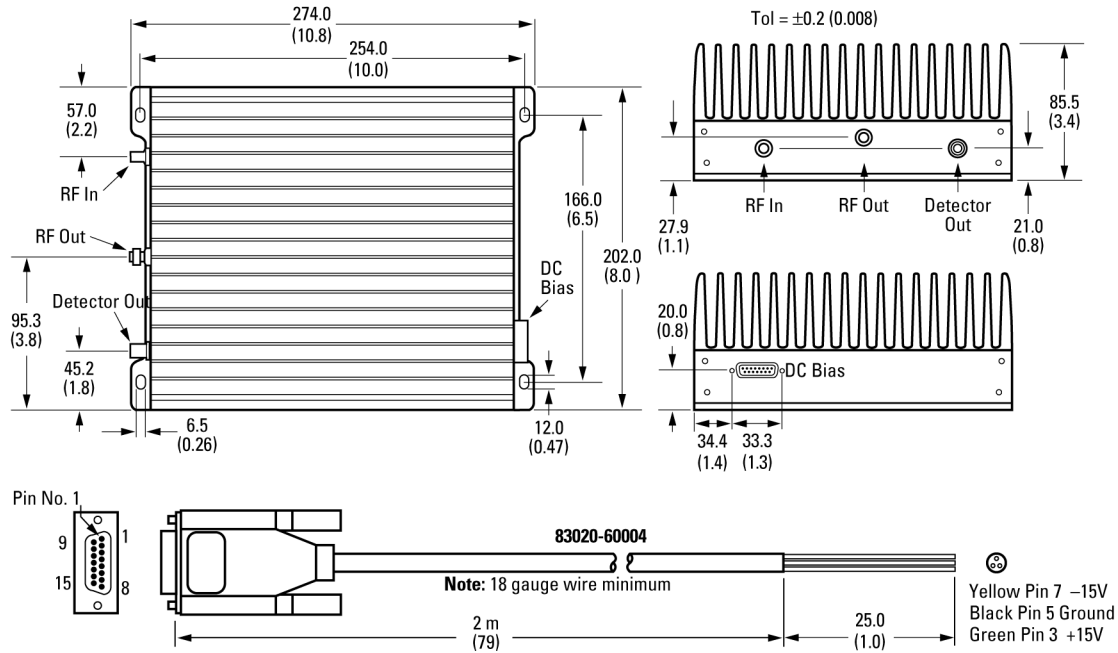

83050A and 83051A

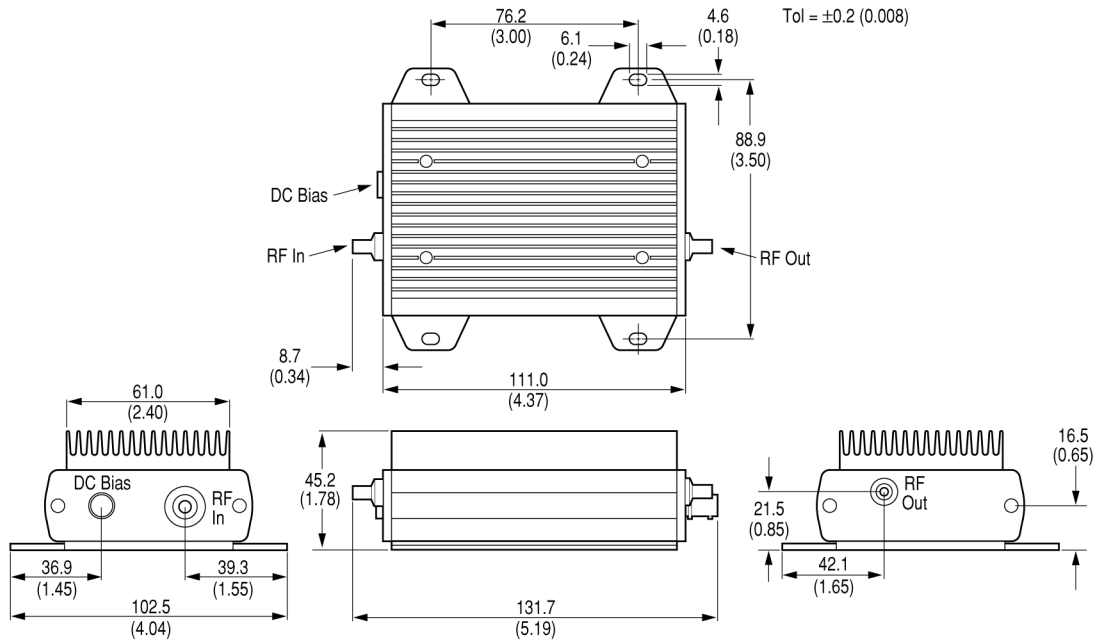

Power supply outline drawings

87421A

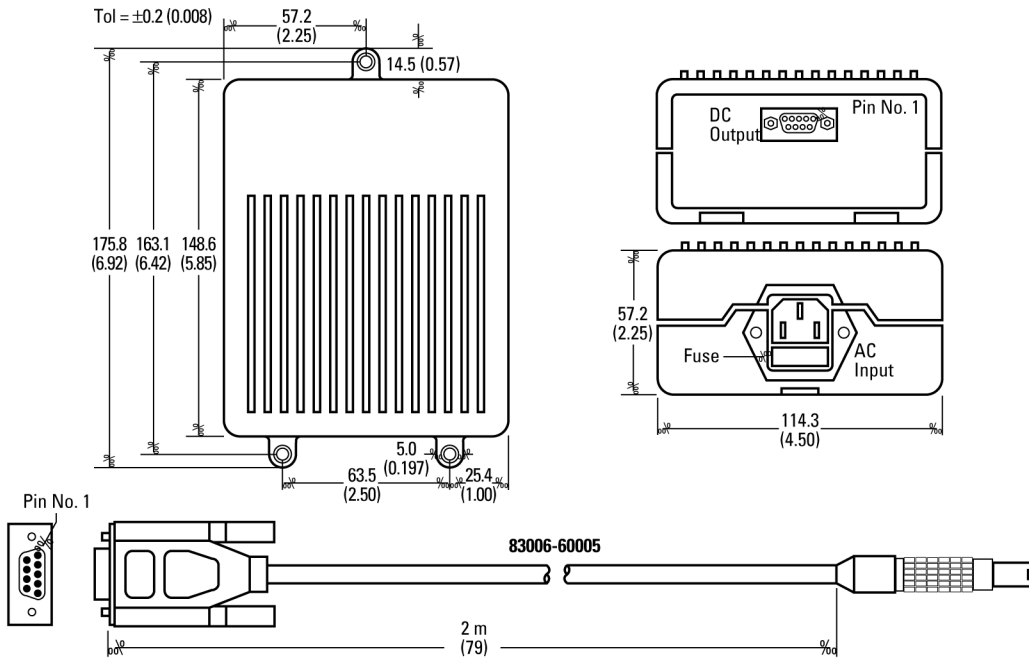

The 87421A power supply provides the dc power needed to bias the 83006A, 83017A, 83018A, 83050A, and 83051A.

87422A

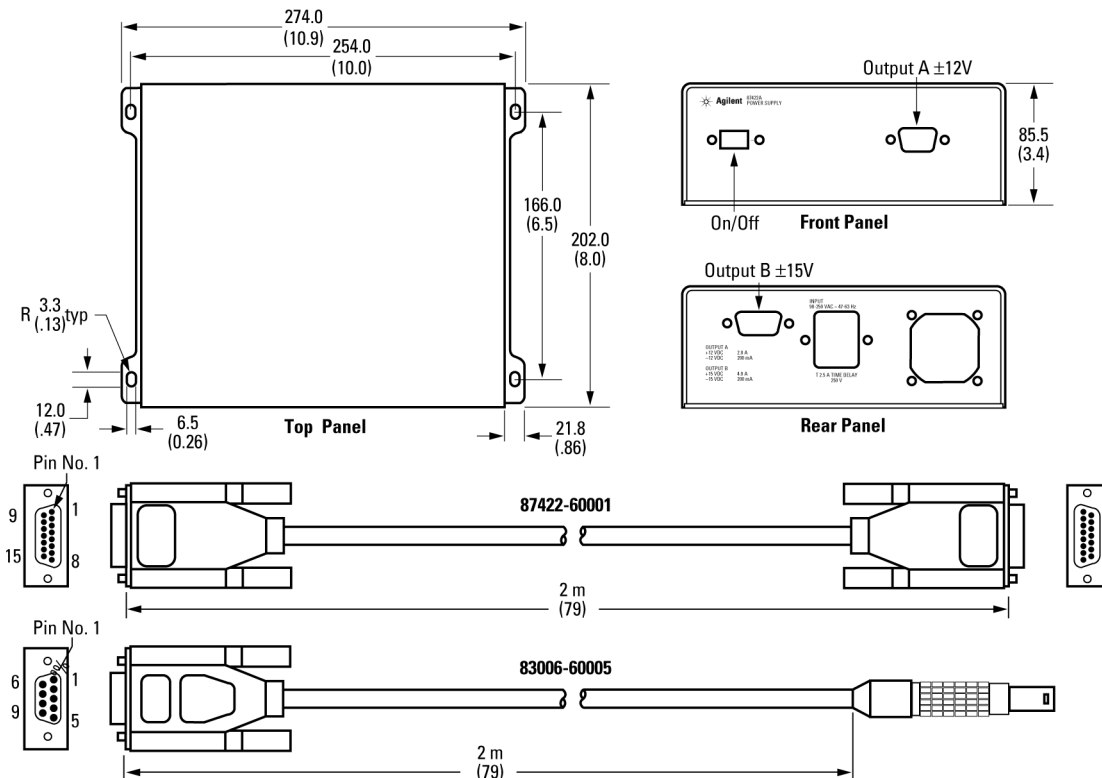

The 87422A power supply provides the dc power needed to bias the 83020A, plus an additional $\pm 12V$ dc output.

Ordering Information

Agilent 83006A, 83017A, 83050A, and 83051A microwave system amplifiers

Includes amplifier and part number 83006-60004, which is a two-meter cable with a three-pin connector on one end and three-wire leads on the other end.

Agilent 83018A microwave system amplifier

Includes amplifier and part number 83006-60004, which is a two-meter cable with a three-pin connector on one end and three-wire leads on the other end.

- **Special applications:** Higher performance models available upon request.

Agilent 83020A microwave system power amplifier

Includes amplifier and part number 83020-60004, which is a two-meter cable with a fifteen-pin connector on one end and three-wire leads on the other end.

- **Option 001:** Delete coupler/detector providing higher output power.
- **Special applications:** Higher performance models available upon request.

Other Instruments and Accessories

Agilent 83036C coaxial GaAs directional detector

0.01–26.5 GHz, for use with the 83006A.

Agilent 87421A power supply

Includes power supply and part number 83006-60005, which is a two-meter cable with a three-pin connector on one end and a D-sub-miniature connector on the other end for direct connection to the 83006A, 83017A, 83018A, 83050A, and 83051A.

Agilent 87422A power supply

Includes power supply and part number 87422-60001, which is a two-meter cable with fifteen-pin connectors for direct connection to the 83020A amplifier. One additional cable, part number 83006-60005, is provided for direct connection of the 12 Vdc output to a preamplifier such as the 83006A, 83017A, 83018A, 83050A, or 83051A.

Related Literature

Agilent 83036C data sheet, 5952-1874

Agilent 87421A/87422A data sheet, 5091-4292E



Agilent Email Updates

www.agilent.com/find/emailupdates
Get the latest information on the products and applications you select.



www.lxistandard.org

LXI is the LAN-based successor to GPIB, providing faster, more efficient connectivity. Agilent is a founding member of the LXI consortium.

Agilent Channel Partners

www.agilent.com/find/channelpartners

Get the best of both worlds: Agilent's measurement expertise and product breadth, combined with channel partner convenience.



Agilent Advantage Services is committed to your success throughout your equipment's lifetime. We share measurement and service expertise to help you create the products that change our world. To keep you competitive, we continually invest in tools and processes that speed up calibration and repair, reduce your cost of ownership, and move us ahead of your development curve.

www.agilent.com/find/advantageservices



www.agilent.com/quality

www.agilent.com
www.agilent.com/find/mta

For more information on Agilent Technologies' products, applications or services, please contact your local Agilent office. The complete list is available at:

www.agilent.com/find/contactus

Americas

Canada	(877) 894 4414
Brazil	(11) 4197 3500
Mexico	01800 5064 800
United States	(800) 829 4444

Asia Pacific

Australia	1 800 629 485
China	800 810 0189
Hong Kong	800 938 693
India	1 800 112 929
Japan	0120 (421) 345
Korea	080 769 0800
Malaysia	1 800 888 848
Singapore	1 800 375 8100
Taiwan	0800 047 866
Other AP Countries	(65) 375 8100

Europe & Middle East

Belgium	32 (0) 2 404 93 40
Denmark	45 70 13 15 15
Finland	358 (0) 10 855 2100
France	0825 010 700* *0.125 €/minute
Germany	49 (0) 7031 464 6333
Ireland	1890 924 204
Israel	972-3-9288-504/544
Italy	39 02 92 60 8484
Netherlands	31 (0) 20 547 2111
Spain	34 (91) 631 3300
Sweden	0200-88 22 55
United Kingdom	44 (0) 118 9276201

For other unlisted Countries:

www.agilent.com/find/contactus

Revised: October 14, 2010

Product specifications and descriptions in this document subject to change without notice.

© Agilent Technologies, Inc. 2002, 2008, 2010, 2011
Printed in USA, June 7, 2011
5963-5110E



Agilent Technologies