

AC Power Source/Analyzers...

an integrated
AC power solution

Agilent AC Power Source/Analyzers provide a complete AC test solution. As AC sources, they combine the capabilities of a power amplifier and an arbitrary waveform generator. This allows you to simulate normal waveforms and many types of distorted power waveforms. The built-in power analyzer combines the capabilities of a multimeter, oscilloscope, harmonic analyzer and power analyzer. These instruments may also be used to produce DC power, either alone or as a DC offset to an AC waveform.

AC Power Source/Analyzers 375-1750 VA



6811B, 6812B, 6813B

Provides a complete AC and DC power and measurement solution
Protect valuable DUTs with extensive protection features
Easy to use Graphical User Interface (GUI)

The Complete AC Power Test Solution

Since your product will have to operate in the real world of unpredictable AC power, you need to design and verify its correct operation under a wide range of AC power inputs. Brownouts, dropouts, sags, and other irregularities are not unusual in many communities today. Agilent AC sources have the features needed to easily accomplish this test goal either in an R&D environment or on the manufacturing test floor. If you plan to sell your products in a worldwide market, you will also need to test them at the line voltages and frequencies that they will eventually operate at. There is also additional testing needed to meet regulatory requirements for sale into some countries.

Agilent AC sources offer a complete solution for AC power testing, helping you to simplify this important task. These instruments combine the features of a power amplifier and arbitrary waveform generator to give you the ability to do all of the tests that you need. There are many standard preprogrammed waveforms, or you can use the

transient generation system to simulate sophisticated and repeatable AC line disturbances. DC power can also be generated, either as a DC offset or as a pure DC signal.

Powerful Built-in Measurement Capabilities

Agilent AC sources have extensive 16-bit precision measurement capabilities which would normally require a number of complex measurement instruments, including a DMM (digital multimeter), oscilloscope, power analyzer, and harmonic analyzer. The precision measurements include:

- rms, DC, AC + DC voltage and current
- peak voltage and current
- real, apparent, and reactive power
- harmonic analysis of voltage and current waveforms providing amplitude and phase up to the 50th harmonic
- THD (total harmonic distortion)
- Triggered acquisition of digitized voltage and current

Using the measurement capabilities of an Agilent AC source simplifies your test setups and helps you obtain accurate data quickly.

Dual Power Analyzer Option 020

The powerful built-in power meter/analyzer in Agilent AC sources provides everything that you need to make AC measurements at the AC input to your DUT. For many test scenarios, this is the extent of the AC analysis required.

Some test scenarios, however, require AC measurements to be made at both the AC input and the AC output of the DUT. Option 020 provides an additional power analyzer, complete with a precision current shunt, which can be connected anywhere you need it. This second analyzer can even be used for tests where the AC source is not providing power, thus expanding the usefulness of this instrument to many more test configurations. The additional analyzer is equivalent in specifications and capabilities to the standard analyzer.

AC Power Source/Analyzers: 375-1750 VA (Continued)

Using the dual power analyzer option instead of an additional power analyzer instrument externally is more than just convenient. Measurements on all four measurement channels (AC source output voltage and current, and dual power analyzer voltage and current inputs) are inherently synchronized with the AC source output waveform. This precision would be difficult to achieve using separate measurement instruments.

Examples Dual Power Analyzer Applications

- Complete testing of uninterruptible power sources (UPS)
- Efficiency testing of DC power supplies
- Efficiency testing of AC power sources
- Efficiency testing of transformers
- Safety testing of transformers
- Line disturbance and brownout testing of DC power supplies
- Line disturbance and brownout testing of AC power sources
- Sleep mode current monitoring
- Independent power analyzer

Sleep Mode Current Monitoring

Many electronic products have power-saving or sleep modes. In this mode, the device draws only enough power to be able to recognize a “wake-up” signal, and then execute a smooth “wake-up”. The power drawn in this mode is a critical parameter, and the ability to accurately monitor it is important.

The accessory precision current shunt that is supplied with option 020 is mounted in such a way to make it easy for you to replace it with a precision resistor of your choice. By doing this, you can configure the system to accurately monitor extremely low currents. This provides an easy way for you to profile the current draw in all modes of your product’s operation. Since Agilent 6811B-6813B AC sources produce DC power as well as AC power, portable battery operated products can also be tested with this configuration.

UPS (uninterruptible power source) Testing

The Dual Power Analyzer Option provides many important benefits for UPS testing. Since the key to correct UPS operation is having the output react properly to changes on the input, being able to monitor the output relative to the input simplifies testing. For example, commands are available to enable calculation of UPS transfer time, and the phase difference between the UPS input and output voltage. Agilent AC sources also have programmable output impedance, enabling the UPS designer to verify product stability over a wide range of AC line impedance.

Free Graphical User Interface (GUI)

When you need to run a variety of tests, study the results carefully, and then run more tests with slightly varied conditions, writing computer programs using the extensive SCPI command set may seem burdensome. This is when you should download the latest copy of the Free Agilent AC Source Graphical User Interface from www.agilent.com.

The Agilent AC source GUI makes it quick and easy to set the output of your Agilent AC source, be it from a stored waveform or with a waveform that you create using your mouse. The GUI also allows you to see the output of the AC source in graphical form, save the results, or dump them directly into a Microsoft Excel file.

Microsoft Excel Link

The direct Excel link feature was recently added to meet the current needs of R&D engineers. It makes it easy to keep the results of many tests, and makes them easily retrievable. With it, the test records resulting from changing conditions can be kept in one place and easily compared.

Access to raw data often helps in fully understanding test results. For example, small local peaks may not be evident in processed data. V, I and phase results from harmonic measurements are particularly susceptible to not showing the complete story in a graphical representation.

AC Power Source/Analyzers: 375-1750 VA (Continued)

Microsoft Excel offers a wide variety of data manipulation and graphical capabilities that can help an engineer gain the fullest understanding from the test data.

Test Suite for Avionics Equipment

Agilent AC sources are well suited for testing equipment intended for use in the avionics industry which operate at nominally 400 Hz. One of the special requirements that many manufacturers in this industry must concern themselves with is testing to meet RTCA DO-160 standards. These standards involve both AC and DC immunity tests. The Agilent AC source GUI includes a section devoted to these tests. By using this tool, you can quickly step through the required set-ups with confidence.

Extensive protection to prevent load damage

In addition to overcurrent, overvoltage, overpower and overtemperature protection, the 6800 series offers output disconnect relays and remote inhibit capability (quickly

disabling the output of the AC source via a TTL signal) to protect the device under test.

The 6800 series is backed by a three-year warranty and Agilent's worldwide network of support and service centers.

Application info

The 6800 series can help you test and improve your products.

You can easily perform:

1. Static testing—generating and measuring voltage, frequency, and line current for meeting worldwide specifications.
2. Dynamic testing—generating AC line transients for limit testing and design verification.
3. Specialty testing—measuring current harmonic content and creating custom AC power waveforms (such as a combined AC + DC signal to simulate a telephone ring).
4. Precompliance regulatory testing—measuring current harmonics, voltage fluctuations and flicker emissions and generating voltage and frequency disturbances and interharmonics to determine product immunity.

Development engineers and test professionals in a wide variety of industries use AC power source/analyzers. Here are a few examples:

Avionics

Instrumentation, ATE test stations

Computer Products

Computers, Monitors, Peripherals

Consumer Products

Home appliances, Audio and video equipment, Heating/cooling controls

Electrical Products

Relays, Transformers, Power components, Fire alarms

Lighting Products

Electronic ballasts, Compact fluorescent bulbs, Timers

Motors

AC motors, Electronic controllers

Power Products

AC/DC adapters, AC/DC power supplies, PBX power supplies, Uninterruptible power supplies

Telecom Products

RF amplifiers, CATV devices, MUX's, routers, switches

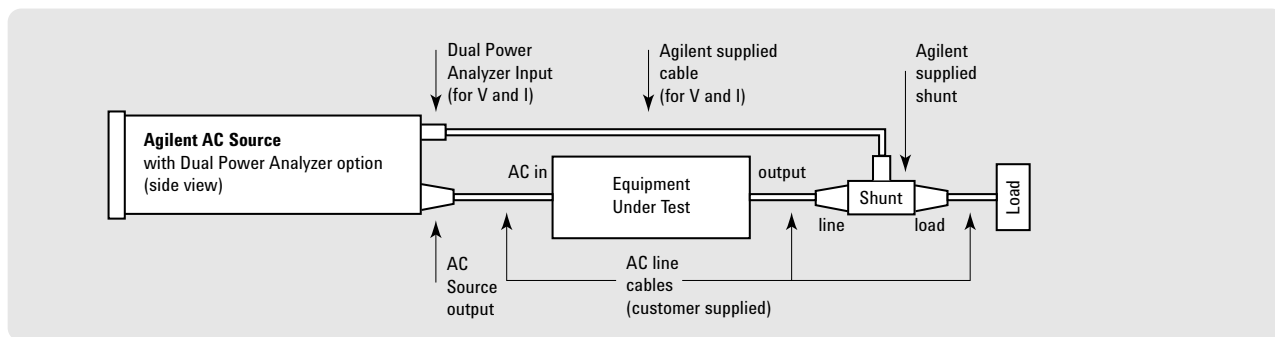

Test configuration of efficiency measurement using an Agilent AC source with the 020 Dual Power Analyzer Option.

AC Power Source/Analyzers: 375-1750 VA (Continued)

AC Source Graphical User Interface

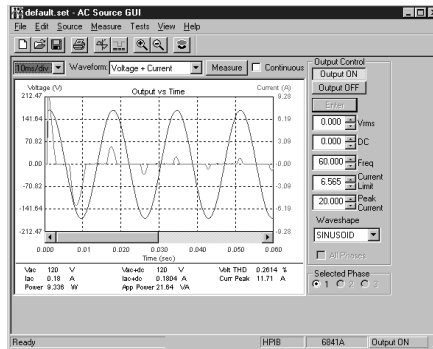

Inrush Current Measurement

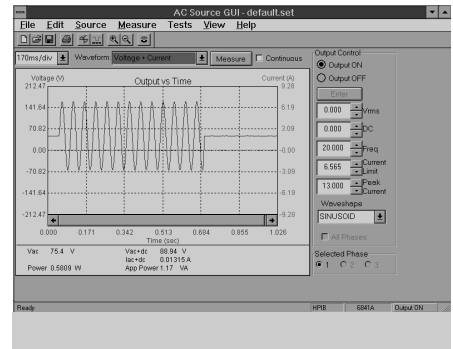

Ringer Voltage (DC + AC) Generation

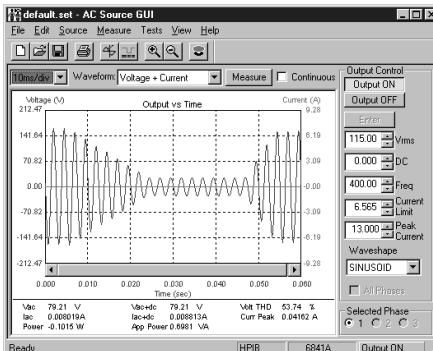

Voltage Slew Control (Brownout)

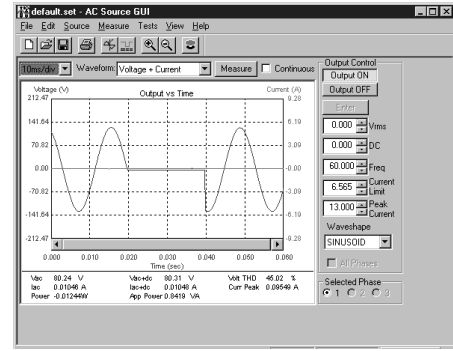

One cycle AC Mains Drop

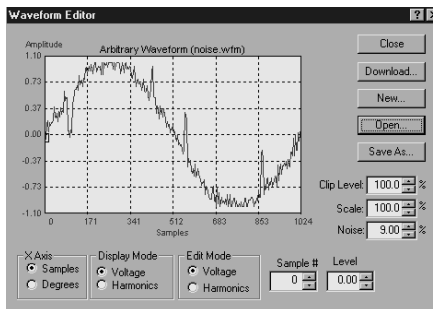

User Defined Waveform: Noise with Spikes

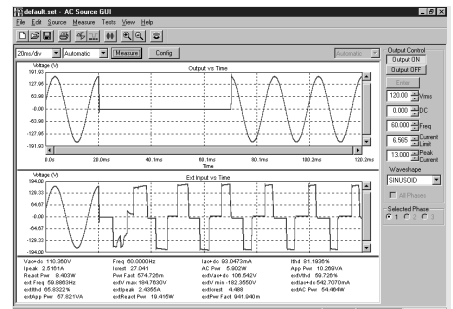

Testing of UPS Input and Output using Dual Power Analyzer Option 020

AC Power Source/Analyzers: 375-1750 VA (Continued)

For a sine wave with a resistive load at 0° to 40° C, within an output frequency range of 45 Hz to 1000 Hz, and in AC coupled mode after a 30 minute warm-up unless otherwise noted.

Notes:

1 Product may be operated between DC and 45 Hz subject to certain deratings. Measurements may be extended to 4.5 Hz at full accuracy only by selecting a digitization rate of 250 μ seconds per point. Frequency content of the measured signal must be limited to 4 k Hz or less to avoid aliasing effects.

Specifications (at 0° to 55° C unless otherwise specified)	6811B	6812B	6813B
Number of phases	1	1	1
Output ratings (Maximum)			
Power	375 VA	750 VA	1750 VA
rms voltage	300 V	300 V	300 V
rms current	3.25 A	6.5 A	13 A
Repetitive & non-repetitive peak current	40 A	40 A	80 A
Crest factor	12	6	6
Load Power factor capability	0 to 1	0 to 1	0 to 1
DC power	285 W	575 W	1350 W
DC voltage	± 425 V	± 425 V	± 425 V
DC current	2.5 A	5.0 A	10.0 A
Output frequency range¹	DC; 45 Hz to 1 kHz	DC; 45 Hz to 1 kHz	DC; 45 Hz to 1 kHz
Constant voltage ripple and noise (20 kHz to 10 MHz)	-60 dB (relative to full scale)	-60 dB (relative to full scale)	-60 dB (relative to full scale)
Line regulation (% of full scale)	0.1%	0.1%	0.1%
Load regulation (% of full scale)	0.5%	0.5%	0.5%
Maximum total harmonic distortion	0.25% at 50/60 Hz 1% worst case 45 to 1 kHz	0.25% at 50/60 Hz 1% worst case 45 to 1 kHz	0.25% at 50/60 Hz 1% worst case 45 to 1 kHz
Programming accuracy			
	(25° \pm 5°C)		
RMS voltage (% of output + offset)	0.15% + 0.3 V (45 - 100Hz) 0.5% + 0.3 V (>100 - 500 Hz) 1% + 0.3 V (> 500 - 1000 Hz)	0.15% + 0.3 V (45 - 100Hz) 0.5% + 0.3 V (>100 - 500 Hz) 1% + 0.3 V (> 500 - 1000 Hz)	0.15% + 0.3 V (45 - 100Hz) 0.5% + 0.3 V (>100 - 500 Hz) 1% + 0.3 V (> 500 - 1000 Hz)
DC voltage	0.1% + 0.5 V	0.1% + 0.5 V	0.5% + 0.3 V
Frequency	0.01% + 10 μ Hz	0.01% + 10 μ Hz	0.01% + 10 μ Hz

AC Power Source/Analyzers: 375-1750 VA (Continued)

Specifications

(at 0° to 55° C unless otherwise specified)

6811B

6812B

6813B

For a sine wave with a resistive load at 0° to 40° C, within an output frequency range of 45 Hz to 1000 Hz, and in AC coupled mode after a 30 minute warm-up unless otherwise noted.

Notes:

1 Product may be operated between DC and 45 Hz subject to certain deratings. Measurements may be extended to 4.5 Hz at full accuracy only by selecting a digitization rate of 250 μ seconds per point. Frequency content of the measured signal must be limited to 4 k Hz or less to avoid aliasing effects.

2 Select low measurement range for improved accuracy (10:1) for lower power measurements.

Measurement Accuracy

(25°C \pm 55°C)

Rms. voltage (45 - 100 Hz)	0.03% + 100 mV ¹	0.03% + 100 mV ¹	0.03% + 100 mV ¹
DC voltage	0.05% + 150 mV ¹	0.05% + 150 mV ¹	0.05% + 150 mV ¹
RMS current (45 - 100 Hz)²			
high range	0.05% + 10 mA	0.05% + 10 mA	0.05% + 10 mA
low range	0.05% + 1.5 mA	0.05% + 1.5 mA	0.05% + 1.5 mA
Power (VA) (45-100 Hz)²			
high range	0.1% + 1.5 VA + 12 mVA/V	0.1% + 1.5 VA + 12 mVA/V	0.1% + 1.5 VA + 12 mVA/V
low range	0.1% + 1.5 VA + 1.2 mVA/V	0.1% + 1.5 VA + 1.2 mVA/V	0.1% + 1.5 VA + 1.2 mVA/V
Power (watts) (45-100 Hz)²			
high range	0.1% + 0.3 W + 12 mW/V	0.1% + 0.3 W + 12 mW/V	0.1% + 0.3 W + 12 mW/V
low range	0.1% + 0.3 W + 1.2 mW/V	0.1% + 0.3 W + 1.2 mW/V	0.1% + 0.3 W + 1.2 mW/V
Frequency	0.01% + 0.01 Hz	0.01% + 0.01 Hz	0.01% + 0.01 Hz
Power factor	0.01	0.01	0.01
Current magnitude			
Fundamental	0.03% + 1.5 mA	0.03% + 1.5 mA	0.03% + 1.5 mA
Low range Harmonics 2-49	0.03% + 1 mA + 0.2%/kHz	0.03% + 1 mA + 0.2%/kHz	0.03% + 1 mA + 0.2%/kHz
Current magnitude			
Fundamental	0.05% + 5 mA	0.05% + 5 mA	0.05% + 5 mA
High range Harmonics 2-49	0.05% + 3 mA + 0.2%/kHz	0.05% + 3 mA + 0.2%/kHz	0.05% + 3 mA + 0.2%/kHz

Supplemental Characteristics

(Non-warranted characteristics determined by design that are useful in applying the product)

Average programming accuracy (% of output + offset) rms current	1.2% + 50 mA	1.2% + 50 mA	1.2% + 50 mA
Average programming resolution			
rms voltage	125 mV	125 mV	125 mV
DC voltage	250 mV	250 mV	250 mV
Oversvoltage programming (OVP)	2 V peak	2 V peak	2 V peak
rms current	2 mA	4 mA	4 mA
peak current	12.5 mA	25 mA	25 mA
output frequency	10 μ Hz	10 μ Hz	10 μ Hz
phase	N/A	N/A	N/A

AC Power Source/Analyzers: 375-1750 VA (Continued)

Specifications

(at 0° to 55° C unless otherwise specified)

6811B

6812B

6813B

For a sine wave with a resistive load at 0° to 40° C, within an output frequency range of 45 Hz to 1000 Hz, and in AC coupled mode after a 30 minute warm-up unless otherwise noted.

AC Input Ratings notes:

- 1 Measured at low line
- 2 Measured at high line

Application Notes:

**Agilent 6800 Series
AC Power Source/Analyzer**
5963-7044E

**Testing Uninterruptible Power
Supplies Using Agilent 6800 Series
AC Power Source/Analyzers,**
5967-6056E

**Simplify your Avionics Testing with a
400 Hz Single Phase Power Source that
includes a Built-in 26 V reference signal**
5989-3700EN

Software Driver:
VXIPlug&Play

Warranty: One year

Supplemental Characteristics

(Continued)

(Non-warranted characteristics determined by design that are useful in applying the product)

Average measurement resolution			
rms voltage	10 mV	10 mV	10 mV
rms current	2 mA	2 mA	2 mA
Programmable output impedance			
resistance	0-1 Ω	0-1 Ω	0-1 Ω
inductance	20 μh - 1 mh	20 μh - 1 mh	20 μh - 1 mh
Remote sense capability	Up to 1 Vrms can be dropped across each load lead.	Up to 1 Vrms can be dropped across each load lead.	Up to 1 Vrms can be dropped across each load lead.
Isolation to ground	300 Vrms/425 Vdc	300 Vrms/425 Vdc	300 Vrms/425 Vdc
Net weight	28.2 kg (62 lb)	28.2 kg (62 lb)	32.7 kg (72 lb)
Shipping weight	31.8 kg (70 lb)	31.8 kg (70 lb)	36.4 kg (80 lb)
Dimensions	See drawings on page 105		

AC Input Ratings

Voltage range (Vac) *default factory setting	87 to 106 Vac *104 to 127 Vac 174 to 220 Vac 191 to 254 Vac	87 to 106 Vac *104 to 127 Vac 174 to 220 Vac 191 to 254 Vac	174 to 220 Vac *191 to 254 Vac
Maximum input current (rms)¹	12 A (100 Vac) 10 A (120 Vac) 7.5 A (200/208 Vac) 6.5 A (230 Vac)	28 A (100 Vac) 24 A (120 Vac) 15 A (200/208 Vac) 13 A (230 Vac)	22 A (200/208 Vac) 20 A (230 Vac)
Input power (max)²	1000 VA/700 W	2500 VA/1400 W	3800 VA/2600 W
Input frequency	47 to 63 Hz	47 to 63 Hz	47 to 63 Hz

AC Power Source/Analyzers: 375-1750 VA (Continued)

Ordering Information

Opt 019 2000 VA AC Power source/
analyzer (6813B only)

Opt 020 Dual power analyzer option
(6813B only)

Opt 026 26 Volt, 0.1A auxiliary
45 to 100 Hz only
reference output (6812B only)

Opt 080 Full documentation
on CD-ROM only

Opt 0L1 Full documentation on
CD-ROM, and/with printed
standard documentation package

Opt 0L2 Extra copy of standard
printed documentation package

Opt 1CM Rack-mount Kit,
p/n 5062-3977 (quantity 2)
(support rails required)

Opt 1CP Rack-mount Kit with Handles,
p/n 5062-3983 (support rails required)
6811B, 6812B, 6813B only

*Support rails, p/n 12679B, required when
rack mounting the 6811B, 6812B, and 6813B
Opt 1CM and Opt 1CP. E3664AC non Agilent rack.
E3663AS for Agilent rack.*

Opt 100 (6811B and 6812B only)
87 to 106 Vac (100 Vac nominal),
47-63 Hz, Japan only

Opt 120 104-127 Vac
(120 Vac nominal), 47-63 Hz

Opt 200 (6813B only) 174-220 Vac
(200 Vac nominal), 47-63 Hz, Japan only

Opt 208 (6811B and 6812B only)
174 to 220 Vac (208 Vac nominal),
47-63 Hz

Opt 230 191 to 254 Vac
(230 Vac nominal), 24-63 Hz

Opt 831 12 AWG, 200 to 240 Vac,
unterminated (6812B, 6813B only)

Opt 832 4 mm² wire size, unterminated
(6813B only)

Opt 833 1.5 mm² wire size, 200 to
240 Vac, unterminated (6812B only)

Opt 834 10 AWG, 100 to 120 Vac,
unterminated (6812B only)

Opt 841 Line Cord with NEMA L6-20P;
20 A 250 V Plug (6812B only)

Opt 842 Line Cord with IEC 309;
32 A 220 V plug (6813B only)

Opt 844 Line Cord with NEMA L6-30P;
30 A 250 V Locking Plug (6813B only)

Opt 845 Line Cord with IEC 309;
16 A 220 V Plug (6812B only)

Opt 846 Line Cord with NEMA L6-30P;
30 A 120 V Plug (6812B only)

Opt 847 Line Cord with CEE 7/7;
16 A 220 V Plug (6812B only)

Opt 848 Line Cord with BS 546;
15 A 240 V Plug (6812B only)

**See the AC line voltage and cord section,
for more details on line cords.**

Agilent Models: 6811B, 6812B, 6813B

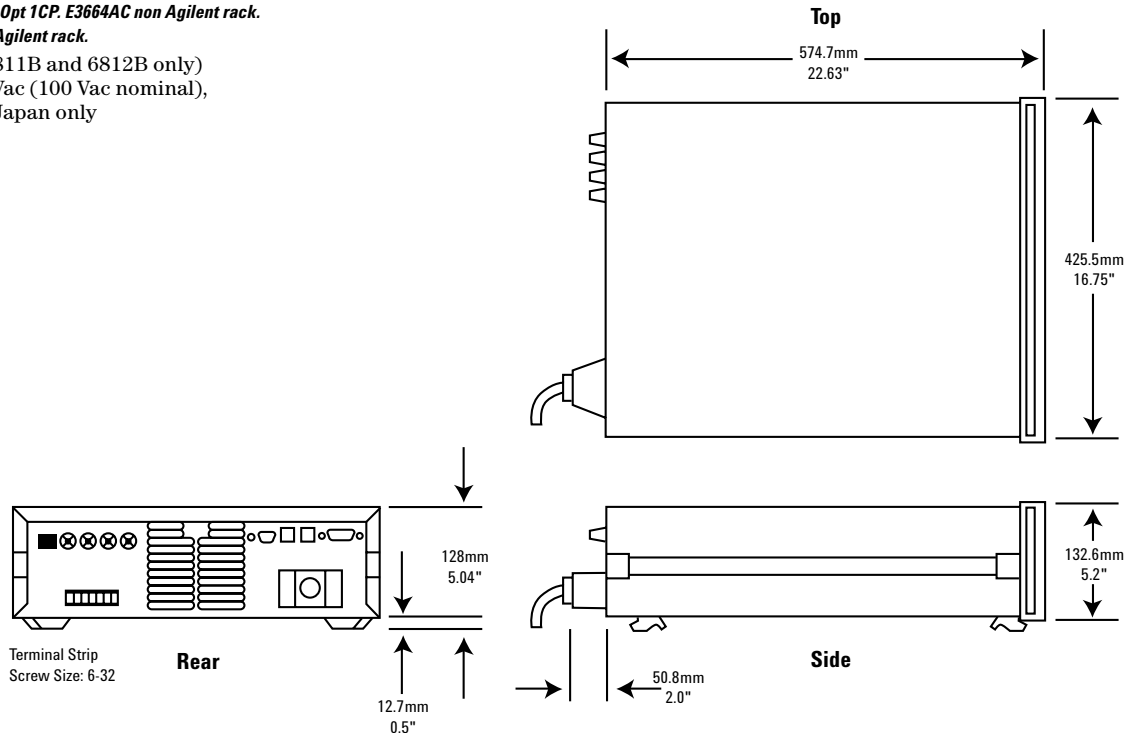

More detailed specifications at www.agilent.com/find/6800

**Your Requested Excerpt from the
Agilent System and Bench Instruments Catalog 2006**

The preceding page(s) are an excerpt from the 2006 System and Bench Instruments Catalog. We hope that these pages supply the information that you currently need. If you would like to have further information about the extensive selection of Agilent DC power supplies, please visit www.agilent.com/find/power to print a copy of the complete catalog, or to request that a copy be sent to you. You will also find a lot of other useful information on this Web site.

In the full System and Bench Instruments Catalog, you will find that Agilent offers much more than DC power supplies. This catalog contains detailed technical and application information on digital multimeters, DC power supplies, arbitrary waveform generators, and many more instruments. If you need basic, clean, power for your lab bench, it's there. In each power product category we have also integrated the capabilities you need for a complete power solution, including extensive measurement and analysis capabilities.

Please give us a call at your local Agilent Technologies sales office, or call a regional office listed, for assistance in choosing or using Agilent power products.

Keep up to date with Agilent's Test and Measurement Email Updates

As an Email Update subscriber, you will receive periodic customized email updates that match the areas of interest that you have specified. Your update will include products and services, applications and support information, events and promotions. Sign up today at www.agilent.com/find/emailupdates. Check off DC power supplies, AC power sources or electronic loads on your registration form, and we will promptly let you know what's new in power products. Our Privacy Statement at www.agilent.com/go/privacy describes our commitment to you regarding your privacy.

www.agilent.com

For more information on Agilent Technologies' products, applications or services, please contact your local Agilent office. The complete list is available at:

www.agilent.com/find/contactus

Phone or Fax

United States:

(tel) 800 829 4444

(fax) 800 829 4433

Canada:

(tel) 877 894 4414

(fax) 800 746 4866

China:

(tel) 800 810 0189

(fax) 800 820 2816

Europe:

(tel) 31 20 547 2111

Japan:

(tel) (81) 426 56 7832

(fax) (81) 426 56 7840

Korea:

(tel) (080) 769 0800

(fax) (080) 769 0900

Latin America:

(tel) (305) 269 7500

Taiwan:

(tel) 0800 047 866

(fax) 0800 286 331

Other Asia Pacific Countries:

(tel) (65) 6375 8100

(fax) (65) 6755 0042

Email: tm_ap@agilent.com

Contacts revised: 09/26/05

Product specifications and descriptions in this document subject to change without notice.

© Agilent Technologies, Inc. 2006
Printed in the USA, February 8, 2006



Agilent Technologies